



ELECTRODES & ACCESSORIES

●pH ●mV(ORP) ●ION ●Conductivity ●Dissolved Oxygen



<http://www.horiba-water.com/>

CONTENTS

pH METER and ELECTRODE COMBINATION TABLE	1
NEW pH ELECTRODE	2
NEW pH ELECTRODE (3-in-1 ELECTRODES , ISFET ELECTRODES).....	3
pH ELECTRODES (GLASS ELECTRODES(G) , REFERENCE ELECTRODES(R))	4
pH ELECTRODES (3-in-1 ELECTRODES , COMBINATION), TEMPERATURE COMPENSATION ELECTRODES, METALLIC ELECTRODES (FOR ORP MEASUREMENT)	5
ELECTRODE SELECTION GUIDE <Referential information>	6
ION ELECTRODES	8
CONDUCTIVITY ELECTRODE CELLS	11
DO ELECTRODES & DO ELECTRODE TIPS	12
ACCESSORIES	13
STANDARD SOLUTIONS, INTERNAL SOLUTION for REFERENCE ELECTRODE & CLEANING SOLUTIONS	15
ACCESSORIES for U-50, U-20XD, U-10, W-20XD SERIES & INTERNAL SOLUTION for REFERENCE ELECTRODE	16
ELECTRODES & ACCESSORIES for TWIN/CARDY	17
HORIBA WATER QUALITY ANALYZER LINEUP	19

pH ELECTRODES

METALLIC ELECTRODES

ION ELECTRODES

CONDUCTIVITY ELECTRODES

DO ELECTRODES

ACCESSORIES

■ Applicable Product Models

Benchtop pH/Water Quality Analyzer	F-70 Series, F-50 Series, F-20/F-20Ⅱ Series, F-10 Series, M-10 Series
Portable pH Meter	D-50 Series, D-20 Series, D-10 Series
Compact pH Meter	B-211/212/213/711/712/713
Benchtop Conductivity Meter	DS-70 Series, DS-50 Series, DS-10 Series
Portable Conductivity Meter	ES-51, ES-10 Series
Compact Conductivity Meter	B-173/771
Compact Ion Meter	B-341/342/343/721/722/731/ 741/742/743/751, C-121/122/131/141
Portable DO Meter	OM-51, OM-10 Series
Portable Water Quality Monitoring System	U-50, U-20XD, U-10 Series

pH METER and ELECTRODE COMBINATION TABLE

	pH					ORP	ION		Conductivity Electrode Cells	Dissolved Oxygen Electrode
	3-in-1 Electrode	Combination Electrode	ISFET Electrode	Single Electrode*1	Reference Electrode	3-in-1 Combination Electrode	Combination Electrode	Single Electrode*1		
	9615-10D	6069-10C	0030-10D	1066A-10C	2060A-10T	9300-10D	6560-10C	8001-10C	9382-10D	9520-10D
	9625-10D	6261-10C	0040-10D	1076A-10C	2565A-10T		6561-10C	8002-10C	3551-10D	9551-20D
	9618-10D						5002A-10C	8003-10C	3552-10D	9551-100D
	9681-10D						6581-10C	8004-10C	3553-10D	9550-20D
	9680-10D						6582-10C	8005-10C	3561-10D	9550-100D
	6367-10D						6583-10C	8006-10C	3562-10D	
	6377-10D							8007-10C	3573-10C	
	6252-10D							8008-10C	3574-10C	
								8009-10C		
								8010-10C		
								8011-10C		
								1512A-10C		
								8201-10C		
								8202-10C		
								8203-10C		
Type										
F-51 · 52, F-71	○	○	○	○	○	○	×	×	×	×
F-53, F-72 · 73	○	○	○	○	○	○	○	○	×	×
F-54	○	○	○	○	○	○	×	×	○	×
F-55, F-74 · 74BW	○	○	○	○	○	○	○	○	○	×
D-51, D-21	○	○	○	×	×	×	×	×	×	×
D-52, D-22	○	○	○	×	×	○	×	×	×	×
D-53, D-23	○	○	○	×	×	○	○	×	×	×
D-54, D-24	○	○	○	×	×	○	×	×	○	×
D-55, D-25	○	○	○	×	×	○	×	×	×	○
F-21 · 22 · 21 II · 22 II	○	○	○	○	○	○	×	×	×	×
F-22C · 22 II C	○	○	○	○	○	○	×	×	×	×
F-23 · 24 · 23 II · 24 II	○	○	○	○	○	○	○	○	×	×
F-23C · 24C · 23 II C · 24 II C	○	○	○	○	○	○	○	○	×	×
M-11, F-11 · 12	○	○*2	○	○*2	○*2	×	×	×	×	×
M-12 · 13, F-13 · 14 · 15 · 16	○	○	○	○	○	○	×	×	×	×
D-11 · 12	○	○*2	○	×	×	×	×	×	×	×
D-13 · 14	○	○*2	○	×	×	○	×	×	×	×

○: Applicable × : Not applicable *1: Reference electrode required for measurement *2: Temperature compensation electrode (4163-10T) required for measurement

Electrode connector and lead wire length:

10 of -10C, -10T, or -10D in the last part of each type shows that the lead wire length is 1.0m. C, T, and D denote connector types for the main unit. The connector type suited for the main unit should be selected.

Only D type connector can be used for the D-20, D-50 series. C, T, D type connectors can be used for all of the F series and M-series.

<Reference>

The liquid junction is the section where the liquid inside the reference electrode comes in contact with the sample liquid. Several junction types are available (ceramic, sleeve, etc.), to meet the requirements of specific samples or applications.

Liquid junction type	Features
Ceramic	A broad range of pH measurements. (Please note that samples of high viscosity may cause clogging.)
Movable sleeve	The larger liquid junction area is ideal for samples of high liquid junction potential, such as those with (1) high viscosity, (2) high salt concentration, or (3) low ionic strength. The liquid junction is easy to clean. High internal solution outflow volume.
Fixed sleeve	The large liquid junction area makes this type somewhat similar to the movable sleeve type. Not recommended for samples of high viscosity, as the sleeve cannot be cleaned.
Double junction	Combination of the ceramic type and the movable sleeve type overcomes the disadvantages of using either separately. When the outflow of the KCl in the internal solution presents a problem, placing the sample or other salt solution in the external tube will ensure stable measurements.

NEW pH ELECTRODE



The latest HORIBA electrode technology is distilled in the new lineup. Two astounding technical innovations fuse high precision with user-friendliness.

ELECTRODE

HORIBA popular ToupH electrode is now even tougher and responds faster

ToupH

Enhanced stability and minimized drift

Integrating two new technologies for faster response times and optimal performance

01 pH fast response glass membrane (Patent pending)

New Technology

The membrane contains HORIBA's unique combination of rare earth metals to improve response time by twofold and to increase durability against chemical substances.

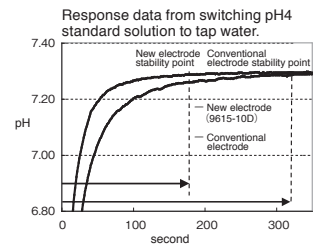

02 Reference electrode with increased stability (Patent pending)

New Technology

Covering the internal electrode with a cation-conductive hollow fiber membrane, liquid junction clogging by silver ions and silver complex ions is reduced to 1/1000 of the conventional technology. Furthermore, maintained internal solution concentration ensures a stable standard electrical potential.

ToupH electrodes are now even stronger

HORIBA's glass membrane molding technology achieves strengths more than 10 times the Japanese Industrial Standards (strength tests).



Not just "unbreakable" .
New flat sensor innovations allow the measurement of trace sample droplets or the measurement of solid sample surface.

ISFET

What is an ISFET (semiconductor sensor) ?

ISFET is the abbreviation of Ion Sensitive Field Effect Transistor. The response membrane is equipped with semiconductor based sensor.

Special features of the ISFET

1. Will not crack or break like conventional glass electrodes
2. The sensor is flat and very small in size, enabling the measurement of extremely small samples
3. Easy handling and maintenance - simply clean with a toothbrush
4. Can be stored dry

The flat electrode has less than a 100µm distance between the housing and the sensor

The unique structure enables to measure minuscule amount of moisture on the surface of solid objects and prevents bubbles from trapping on the sensor when measuring samples in a beaker.

Effects of static electricity reduced

The combination of HORIBA's unique semiconductor device construction and improved static protection circuit means that the effects of static electricity, once the Achilles heel of semiconductor sensors, are greatly reduced.

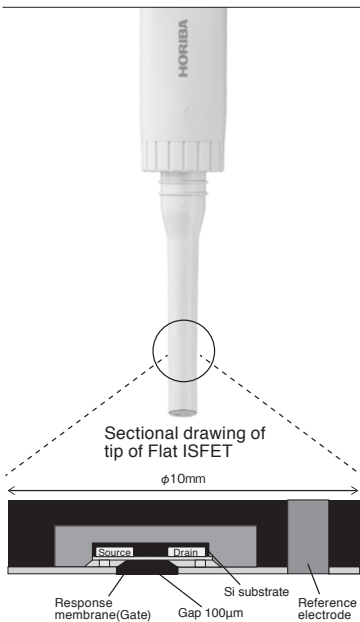

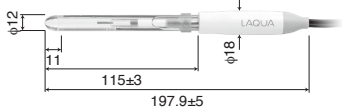
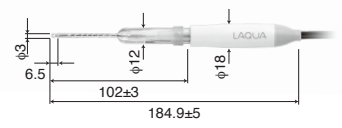
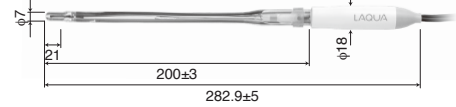
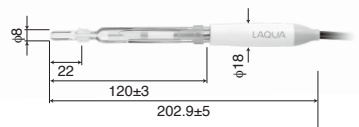
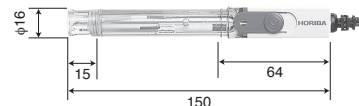

NEW pH ELECTRODE (3-in-1 ELECTRODES, ISFET ELECTRODES)

3-in-1 ELECTRODES

Type	Applicable temperature range(°C)	pH range	Liquid junction	Internal solution	Feature
9615-10D General laboratory application ToupH Standard ToupH electrode  3200366539	0-100	0-14	Ceramic	#300 (KCl)	Quick stability, and reduction of drift.No more worries about the timing of your measurement value readings. ●Uses responsive glass that is 10 times stronger than JIS standards. The domed shape provides strength in all directions, greatly reducing damage concerns.●Constructed with smooth surfaces for easy wiping and cleaning. ●Waterproof ●Pb free (Recommended) Perfect for preparing buffers. Can be used on a wide range of aqueous test solutions. (Post 9611-10D,6366-10D model)
9618-10D Precious trace amount sample ToupH Micro ToupH electrode  3200366552	0-60	0-14	Ceramic	#300 (KCl)	This pH electrode with temperature compensation sensor can take measurements from samples as small as 50 μL. ●Compatible with extremely small containers such as micro tubes etc. ●Waterproof ●The temperature sensor is placed next to the response section for high-speed temperature response. (Recommended) Can be used for a wide range of aqueous solutions, including those that cannot be obtained in large quantities. We recommend using our specialized cleaning solution after measuring samples that contain proteins. (Post 9669-10D model)
9680-10D For large containers and long test tubes ToupH Long ToupH electrode  3200366560	0-100	0-14	Ceramic	#300 (KCl)	283 mm length & 8 mm diameter. The long, thin design makes this electrode perfect for measuring in large containers and test tubes. ●Uses responsive glass that is 10 times stronger than JIS standards. ●Constructed with smooth surfaces for easy wiping and cleaning. ●Waterproof ●Pb free (Recommended) For measuring samples such as microbe culture fluids in test tubes. We recommend that it be used with the long type electrode stand (FA-70L). (Post 9678-10D,6378-10D model)
9681-10D High viscosity application ToupH Sleeve ToupH electrode  3200366572	0-60	0-14	Movable sleeve	#300 (KCl)	Stable measurement can also be achieved for highly viscous samples. ●The liquid junction section is constructed with a moveable sleeve that can be rinsed clean, preventing highly viscous samples from clogging the liquid junction, and maintaining stable measurement performance.●Waterproof ●Pb free (Recommended) For highly viscous samples and solutions, and samples that contain non-aqueous solvents (such as cosmetics or paints). We recommend that you take measurements while using the graph display function to confirm stable responses. (Post 9677-10D model)
9625-10D Plastic body type  3200360505	0-100	0-14	Ceramic	#300 (KCl)	Cased in a plastic body to enable field measurements.The slide-type internal solution filler permits submerged measurements in depths up to 1m (for up to 30 minutes) ●Waterproof ●Pb free (Recommended) Suitable for measurements for tap water, drinking water, field measurements. (Post 9621-10D model)

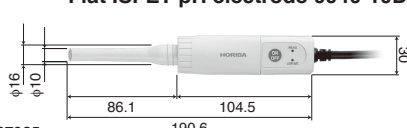
ISFET ELECTRODES

Type	Applicable temperature range(°C)	pH range	Liquid junction	Feature
0040-10D Surface of solid samples Flat ISFET pH electrode 0040-10D  3200367925 0141 Replacement sensor for 0040-10D 3200367926	0-60	0-14	Porous sintered polyethylene	The sensor is located on the flat surface of the tip, with less than a 100 μm difference from the housing. ●Measurements can be made from a minute amount of moisture on the solid sample surface.●Use of a semiconductor sensor means there are no concerns that the electrode will be damaged. ●Also perfect for measuring samples in shallow containers such as Petri dishes.●Waterproof●Replaceable Sensor (Recommended) For surface measurement of gelatinous materials such as nutrient agar, and foodstuffs such as meat. Evaluation of sheet materials such as cloth or paper.If the sample only has a small amount of moisture, pure water etc. is required.
0030-10D Inside solid samples Needle ISFET electrode  3014028323 (9096002100) 0131 Replacement sensor for 0030-10D 3014028400 (9096002200)	0-60	0-14	ABS,epoxy, polyethylene, Ta ₂ O ₅ , platinum	The sharp tip can pierce solid samples to take measurements. ●Use of a semiconductor sensor means there are no concerns that the electrode will be damaged.●Waterproof (Recommended) For measuring inside foodstuffs, such as fruits, vegetables and bread.

pH ELECTRODES (GLASS ELECTRODES(G), REFERENCE ELECTRODES(R))

Glass electrodes measure the pH value in the sample solution by detection of electromotive force, i.e., voltage.

HORIBA's superior glass electrodes have all the qualities required for accurate measurement and testing: they are responsive to changes in electromotive force, sensitive to very slight alkaline differences, have a low internal resistance, and are extremely durable. HORIBA's electrodes are perfect not only for laboratory pH measurement conditions, but are in widespread general use for pH measurement.

Our series of electrodes for use with HORIBA's F, M, & D Series of pH meters incorporate a composite lithium glass for the pH-responsive glass membrane. This gives them extremely high sensitivity. They connect to the industry-standard universal BNC connectors. The holder portion has a squared-off design to prevent the electrode from rolling, protecting it from damage.

Reference electrodes constitute part of the detection portion of pH meters; they are used together with a glass electrode to isolate the electromotive force generated in the glass electrode. HORIBA's reference electrodes use a top-quality internal reference electrode and a liquid junction with numerous special features; this gives them an incredible stable indication of electrical potential, making them particularly suitable as reference electrodes in all types of pH and electrical potential measurement. These electrodes have a double-junction configuration, incorporating two types of liquid junction, using capillary tubes, a sleeve with large surface area, and an easy-to-use ceramic filter.

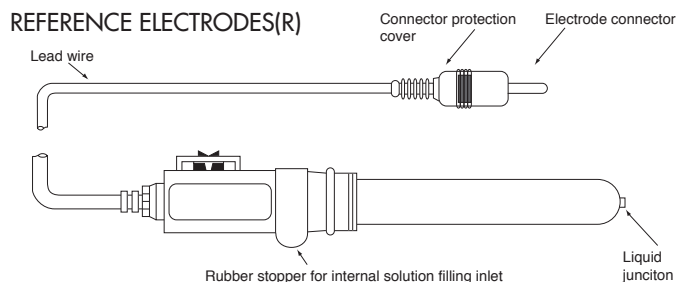
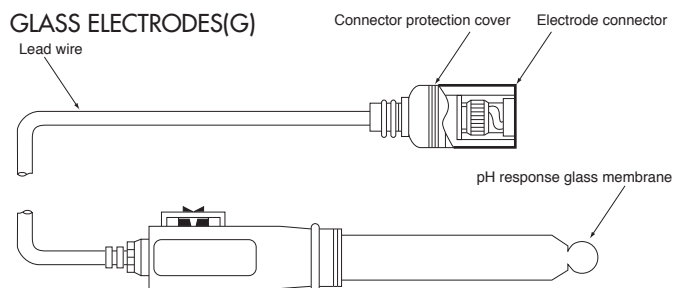

Glass Electrodes(G)

Type	Usage	Applicable temperature range(°C)	pH range	Applicable reference electrode	Feature
1066A-10C Standard type 3014080432 (9003012200)	 Glass electrode 1066A-10C Reference electrode 2060A-10T or other	0-100	0-14	2060A 2565A	Very durable minimum alkali errors. Most widely used for general pH measurements.
1076A-10C For measurement of low-conductivity water and non-aqueous solvents. 3014093084 (9003014200)	 Glass electrode 1076A-10C Reference electrode 2060A-10T or other	0-100	0-14	2060A 2565A	Uses a glass membrane highly sensitive to low-conductivity water and non-aqueous solvents. Can also be used for ordinary pH measurement.

Reference Electrodes(R)

Type	Applicable temperature range(°C)	Liquid junction	Internal solution	Applicable glass electrode	Feature
2060A-10T Standard type 3014080434 (9003012500)	0-100	Ceramic	#300 (KCl)	1066A 1076A	Suitable for a wide range of pH measurements since the resistance of the liquid junction is small.
2565A-10T Double-junction type 3014080436 (9003012700)	0-100	Intermediate: Ceramic External: Sleeve	#300 (KCl)	1066A 1076A	Suitable for measurements of liquid other than normal aqueous solutions, such as suspensions, emulsions, paste, and non-aqueous solutions. When the potassium chloride solution of the internal solution reacts with the sample, measurements can be stably carried out by filling the sample or any other chloride solution in the external jacket. The replacement of the internal solution and the cleaning of the liquid junction can be carried out easily.

pH ELECTRODES (3-in-1 ELECTRODES, COMBINATION), Temperature Compensation Electrode, METALLIC ELECTRODES (FOR ORP MEASUREMENT)

Combination electrodes are a glass electrode and a reference electrode incorporated into one unit. 3-in-1 electrodes incorporate a glass electrode and a reference electrode-plus a temperature compensation electrode-into a single unit.

These electrodes are compact and easy to use; they give superb results in pH measurements over a broad range of sample liquids and test conditions. Also, since the glass membrane and the liquid junction are adjacent, only a small amount of sample fluid is required and they are extremely simple to clean. The internal reference electrode uses a solution of 3.33 mol/L KCl.

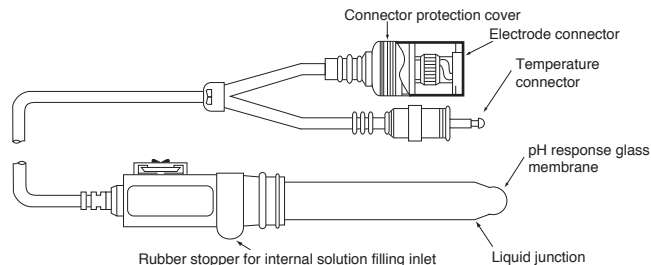

3-in-1 Electrodes

Type	Applicable temperature range(°C)	pH range	Liquid junction	Internal solution	Feature
6367-10D Standard type (sleeve) 3014079136 (9003011800)	0-60	0-14	Sleeve	#300 (KCl)	Uses a sleeve for the liquid junction, improving the stability and repeatability. For measuring pH at high accuracy. (Standard accessory for model F-24II.)
6377-10D For measurement of low-conductivity water and non-aqueous solvents 3014093085 (9003014100)	0-60	0-14	Movable sleeve	#300 (KCl)	Uses a glass membrane highly sensitive to low-conductivity water and non-aqueous solvents. Movable sleeve used at the liquid junction.
6252-10D For food application (needle type) 3014080850 (9003013800)	0-60	0-12	Ceramic	#300 (KCl)	Needle electrode allows measurement of aqueous solutions too.

Combination Electrodes

Type	Applicable temperature range(°C)	pH range	Liquid junction	Internal solution	Feature
6069-10C For very slender test tubes 3014081107 (9003013500)	0-60	0-14	Ceramic	#310 (KCl with AgCl)	For measuring pH of a small amount of sample in a slender tube (more than 3.5 mm dia.) such as a NMR test tube.
6261-10C Flat type 3014081807 (9003013700)	0-50	0-12	Sleeve	#300 (KCl)	Since the pH response membrane and the liquid junction are located on the same surface, pH values on the surfaces of skin, leather, paper, and leaves can be measured.

Temperature Compensation Electrode

Type	Applicable temperature range(°C)	Applicable	Temperature compensation element	Feature
4163-10T 3014080375 (9003013000)	0-100	Temperature compensation and measurement	Thermistor	Used to automatically compensate the changes in the electromotive force of the pH electrode due to temperatures and also to measure temperatures.

Metallic Electrode (For ORP Measurement)

Type	Applicable temperature range(°C)	Electrode material	Applicable reference electrode	Internal solution	Feature
9300-10D Waterproof platinum combination type 3014046710 (9096000400)	0-60	Pt	—	#300 (KCl)	Waterproof. Uses a flat type metallic electrode, which allows a small amount of sample to be measured.

ELECTRODE SELECTION GUIDE <Referential information>

		3-in-1 ELECTRODES(ToupH)				ISFET ELECTRODES	
		STANDARD ToupH	MICRO ToupH	LONG ToupH	SLEEVE ToupH	NEEDLE ISFET	FLAT ISFET
		9615-10D	9618-10D	9680-10D	9681-10D	0030-10D	0040-10D
Specification	Applicable temperature range (°C)	0-100	0-60	0-100	0-60	0-60	0-60
	Diameter(mm)	12	3	8	12	15	10
	Position of liquid junction(approx.mm)	13	6	21	26	11	0.1
	Length(mm)	198	185	283	203	190	190
pH - Sample Conditions							
Aqueous Solution	Conductivity	Normal (over 10mS/m)	◎	◎	◎	◎	◎
		Low (approx. 1mS/m)					
		High (approx. 5S/m)	○		○	◎	
	Strong alkaline (pH 10-12)/acidity (pH 0-2)	◎		○	○		
	Quick heat change (within 50°C)						
	High viscosity (approx. 5 Pa·S)				◎		
	Containing non-aqueous solvent	○	○	○	○	○	○
	Suspension	○	○	○	◎	○	○
Solid/Semisolid	Inside					◎	
	Surface						◎
pH - Sample Containers							
Sample Containers	Microtube/plate (> 50 µL)	×	◎	×	×	×	×
	NMR tube	×	×	×	×	×	×
	Ampule		◎				
	Micro container (> 2 mL)		◎	○			
	Tube	ID:13mm, L:100 ~ 150mm			◎		
	Beaker	10mL ~ 1L	◎	○	○	○	○
	Large container (> 1L)		○		◎		
	Petri dish						◎
Droplet	×	×	×	×	×	◎	
pH - Typical Samples							
Water	Pure/ion-exchange water (approx. 0.1mS/m)						
	Distilled water (approx. 0.5mS/m)	○			○		
	Tap/drinking water (approx. 10mS/m)	◎			○		
	Surface water	○			○		
	Pharmaceutical water	○			○		
	Environment water/acid rain	○			○		
Chemical agent/solvent	Caustic/strong acid	◎			○		
	Organic solvent					×	×
	KCl-reactive solution	×	×	×	×	×	×
	Surfactant	○			◎		
	Water-based paint	○			◎		
	Dye/coloring agent				◎		
Pharmaceutical/biology sample	Protein-containing sample	○	○		◎		
	Medicinal preparation		○		○		
	Enzyme solution		◎	○			
	Tris buffer	◎	○		○		
	Suspension	○			◎		
	Agar medium						◎
Food	Jam	○			◎	◎(inside)	◎(surface)
	Meat/fish					◎(inside)	◎(surface)
	Fruit/vegetable					◎(inside)	◎(surface)
	Dough					◎(inside)	◎(surface)
	Honey				○	○(inside)	○(surface)
	Cheese/butter					◎(inside)	○(surface)
	Yogurt	○			○	◎(inside)	◎(surface)
Beverage/seasoning	Beer	○			○		
	Milk	○			◎		
	Carbonated drink/juice/sauce/soy sauce	○			◎		
	Mayonnaise/ketchup	○			◎		
Cosmetic/lotion	Beauty cream/mascara	○			◎	○	
	Gel/soap/shampoo	○			◎		
	Hairdye lotion	○			◎		
	Emulsified liquid	○			○		

◎Recommended ○Can be measured ×Prohibited or risk of damage

* Representative sample names are shown in the table, therefore they may not apply to all cases. * A reference electrode is necessary for a glass electrode.

	3-in-1 ELECTRODES				COMBINATION ELECTRODES		GLASS ELECTRODES		REFERENCE ELECTRODES	
	PLASTIC	SLEEVE	NON-AQUEOUS	NEEDLE	SLENDER TEST TUBE	FLAT	STANDARD	NON-AQUEOUS	STANDARD	DOUBLE
	9625-10D	6367-10D	6377-10D	6252-10D	6069-10C	6261-10C	1066A-10C	1076A-10C	2060A-10T	2565A-10T
	0-100	0-60	0-60	0-60	0-60	0-50	0-100	0-100	0-100	0-100
	16	12	12	12	3	12	12	12	12	15
	15	10	23	13	8	—	—	—	—	—
	150	150	150	150	291	150	150	150	150	150

	⊙	⊙	⊙	⊙	⊙	⊙	⊙	⊙	⊙	⊙
			⊙					⊙		⊙
	○						○		○	○
	⊙	○					○		○	○
		○	⊙				○	○		○
		○	⊙					⊙		⊙
			⊙				○	○		○
				○						
						○				

	×	×	×	×	×	×	×	×	×	×
	×	×	×	×	⊙	×	×	×	×	×
					○		×	×	×	×
							×	×	×	×
	⊙	○	○	○	○	○	○	○	○	○
	○						○	○	○	○
						⊙	×	×	○	×
	×	×	×	×	×	○	×	×	×	×

			⊙					○		○
			⊙					○		○
⊙			⊙				○	○	○	○
	○	○	⊙				○	○	○	○
			⊙					○	○	○
×			○					⊙		⊙
×	×	×	×	×	×	×	○	○	×	⊙
			○				○	○		○
			○				○	○		○
			○					○		○
			○					○		○
			○					○		○
			○					○		○
			○					○		○
			○					○		○
			⊙				⊙			○
			○				○	○		○
○	○		○				○	○		○
○	○		⊙					⊙		⊙
	○		○				○	○		○
	○		○				○	○		○
			○				○	○		○
			○					○		○
			○					○		○
			○					○		○
			○					○		○
			⊙					○		○

ION ELECTRODES

See P4 for information about reference electrodes.

Ion-selective electrodes are responsive to concentration of particular ions in the test liquid and are variable-potential electrodes. They are used in conjunction with reference electrodes to measure the concentration of particular ions. HORIBAS years of experience and know-how in this field are behind the wide range of ion electrodes we offer.

When measurements are made using an ion meter, by calibrating with various standard solutions, direct readings of the concentration of the ion in question can be taken. Note that since volume-detection level changes with temperature, measurements must be taken at a fixed temperature.

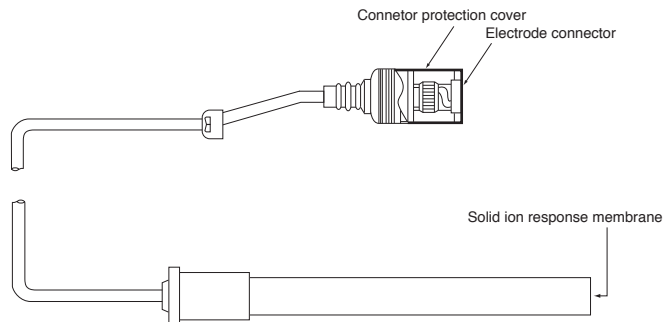

①: Measuring range ②: pH range ③: Applicable temperature range ④: Response time (90%)

Type	Measuring range	Applicable reference electrode	Selection coefficient
Cyanide ion electrode 8001-10C 3014094393 (9003015500)	①: 0.03 to 2,600 mg/L CN ⁻ (10 ⁻⁶ to 10 ⁻¹ mol/L CN ⁻) ②: 2.6 mg/L (10 ⁻⁴ mol/L) CN ⁻ pH 12 to 13 ③: 0 to 50°C ④: Within 10 seconds	2060A, 2565A	S ²⁻ , MnO ₄ ⁻ = Not acceptable I ⁻ = 0.1 S ₂ O ₃ ²⁻ = 1
Chloride ion electrode (combination) 6560-10C 3014093430 (9003014500)	①: 0.35 to 35,000 mg/L Cl ⁻ (10 ⁻⁵ to 1 mol/L Cl ⁻) ②: 350 mg/L (10 ⁻² mol/L) Cl ⁻ pH 3 to 11 ③: 0 to 50°C ④: Within 5 seconds	—	S ₂ O ₃ ²⁻ , S ²⁻ , I ⁻ , Ag ⁺ , Hg ²⁺ = Not acceptable SCN ⁻ = 0.3 MnO ₄ ⁻ = 0.1 Br ⁻ = 0.03 NO ₃ ⁻ , F ⁻ , HCO ₃ ⁻ , SO ₄ ²⁻ , PO ₄ ²⁻ = 1,000
Chloride ion electrode 8002-10C 3014094394 (9003015600)	①: 0.35 to 35,000 mg/L Cl ⁻ (10 ⁻⁵ to 1 mol/L Cl ⁻) ②: 350 mg/L (10 ⁻² mol/L) Cl ⁻ pH 3 to 11 ③: 0 to 50°C ④: Within 5 seconds	2565A	S ₂ O ₃ ²⁻ , S ²⁻ , I ⁻ , Ag ⁺ , Hg ²⁺ = Not acceptable SCN ⁻ = 0.3 MnO ₄ ⁻ = 0.1 Br ⁻ = 0.03 NO ₃ ⁻ , F ⁻ , HCO ₃ ⁻ , SO ₄ ²⁻ , PO ₄ ²⁻ = 1,000
Sulfide ion electrode 8003-10C 3014094395 (9003015700)	①: 0.32 to 32,000 mg/L S ²⁻ (10 ⁻⁵ to 1 mol/L S ²⁻) ②: 3.2 mg/L (10 ⁻⁴ mol/L) S ²⁻ pH 12 to 14 ③: 0 to 50°C ④: Within 10 seconds	2060A, 2565A	CN ⁻ = Not acceptable S ₂ O ₃ ²⁻ = 10 I ⁻ , F ⁻ , Cl ⁻ , PO ₄ ²⁻ , SO ₄ ²⁻ = 1,000
Iodide ion electrode 8004-10C 3014094396 (9003015800)	①: 0.0127 to 12,700 mg/L I ⁻ (10 ⁻⁷ to 10 ⁻¹ mol/L I ⁻) ②: 1,270 mg/L (10 ⁻² mol/L) I ⁻ pH 2 to 11 ③: 0 to 50°C ④: Within 10 seconds	2060A, 2565A	MnO ₄ ⁻ , S ²⁻ , CN ⁻ = Not acceptable S ₂ O ₃ ²⁻ = 10 NO ₃ ⁻ = 100 Br ⁻ = 1,000
Bromide ion electrode 8005-10C 3014094397 (9003015900)	①: 0.8 to 80,000 mg/L Br ⁻ (10 ⁻⁵ to 1 mol/L Br ⁻) ②: 800 mg/L (10 ⁻² mol/L) Br ⁻ pH 1.5 to 11.5 ③: 0 to 50°C ④: Within 5 seconds	2565A	S ₂ O ₃ ²⁻ , I ⁻ , S ²⁻ , CN ⁻ = Not acceptable MnO ₄ ⁻ = 1 Cl ⁻ , PO ₄ ²⁻ = 100 F ⁻ , NO ₃ ⁻ , SO ₄ ²⁻ = 1,000
Copper ion electrode 8006-10C 3014094398 (9003016000)	①: 0.06 to 6,350 mg/L Cu ²⁺ (10 ⁻⁶ to 10 ⁻¹ mol/L Cu ²⁺) ②: 6.35 mg/L (10 ⁻⁴ mol/L) Cu ²⁺ pH 2 to 6 ③: 0 to 50°C ④: Within 10 seconds	2565A	Fe ²⁺ = 0.1 Ni ²⁺ , Na ⁺ = 1,000
Cadmium ion electrode 8007-10C 3014094399 (9003016100)	①: 0.1 to 11,240 mg/L Cd ²⁺ (10 ⁻⁶ to 10 ⁻¹ mol/L Cd ²⁺) ②: 11 mg/L (10 ⁻⁴ mol/L) Cd ²⁺ pH 3 to 8 ③: 0 to 50°C ④: Within 10 seconds	2060A, 2565A	Cu ²⁺ , Hg ²⁺ , Ag ⁺ = Not acceptable Pb ²⁺ = 0.1 Fe ³⁺ = 1 Cr ³⁺ , Fe ²⁺ = 100 Ni ²⁺ = 1,000

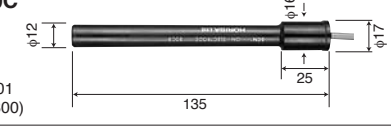
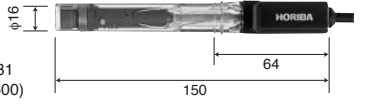
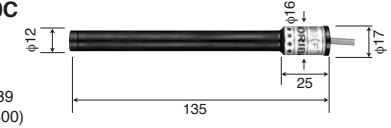
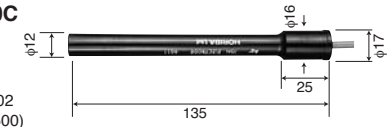
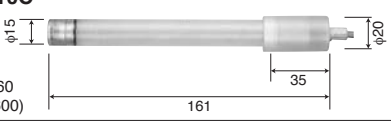
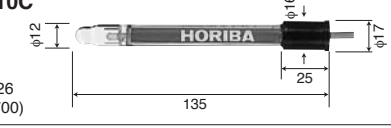
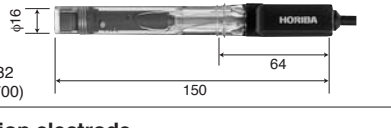
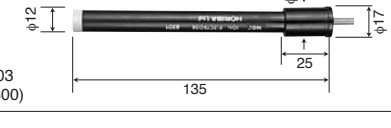
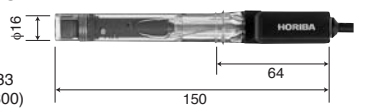
Type	Measuring range	Applicable reference electrode	Selection coefficient
Lead ion electrode 8008-10C  <p>3014094400 (9003016200)</p>	①: 2 to 20,000 mg/L Pb ²⁺ (10 ⁻⁵ to 10 ⁻¹ mol/L Pb ²⁺) ②: 20 mg/L (10 ⁻⁴ mol/L) Pb ²⁺ pH 4.5 to 6.5 ③: 0 to 50°C ④: Within 10 seconds	2565A	Cu ²⁺ , Hg ²⁺ , S ²⁻ , Ag ⁺ = Not acceptable Fe ³⁺ = 0.01 Cr ³⁺ = 1 Cd ²⁺ = 10 Ni ²⁺ , Mg ²⁺ , Zn ²⁺ = 100 NH ₄ ⁺ , K ⁺ = 1,000
Thiocyanate ion electrode 8009-10C  <p>3014094401 (9003016300)</p>	①: 0.6 to 5,800 mg/L SCN ⁻ (10 ⁻⁵ to 10 ⁻¹ mol/L SCN ⁻) ②: 5.8 mg/L (10 ⁻⁴ mol/L) SCN ⁻ pH 2 to 12 ③: 0 to 50°C ④: Within 30 seconds	2565A	CN ⁻ , I ⁻ , S ²⁻ , S ₂ O ₃ ²⁻ = Not acceptable Br ⁻ = 1 Cl ⁻ = 100
Fluoride ion electrode (combination) 6561-10C  <p>3014093431 (9003014600)</p>	①: 0.02 to 19,000 mg/L F ⁻ (10 ⁻⁶ to 1 mol/L F ⁻) ②: 20 mg/L (10 ⁻³ mol/L) F ⁻ pH 4 to 10 ③: 0 to 50°C ④: Within 5 seconds	—	Possible interference when multiply-charged ion (ex. Al ³⁺ , Fe ³⁺) coexisted and foamed the complex.
Fluoride ion electrode 8010-10C  <p>3014093439 (9003016400)</p>	①: 0.02 to 19,000 mg/L F ⁻ (10 ⁻⁶ to 1 mol/L F ⁻) ②: 20 mg/L (10 ⁻³ mol/L) F ⁻ pH 4 to 10 ③: 0 to 50°C ④: Within 5 seconds *1	2060A, 2565A	Possible interference when multiply-charged ion (ex. Al ³⁺ , Fe ³⁺) coexisted and foamed the complex.
Silver ion electrode 8011-10C  <p>3014094402 (9003016500)</p>	①: 0.01 to 110,000 mg/L Ag ⁺ (10 ⁻⁷ to 1 mol/L Ag ⁺) ②: 1 mg/L (10 ⁻⁵ mol/L) Ag ⁺ pH 2 to 10 ③: 0 to 50°C ④: Within 10 seconds	2565A	Hg ²⁺ = Not acceptable Cu ²⁺ , Cd ²⁺ , Pb ²⁺ , Zn ²⁺ , Mg ²⁺ , Ca ²⁺ , Na ²⁺ , K ⁺ = over 1,000
Ammonia ion electrode (combination) 5002A-10C  <p>3014093560 (9003016600)</p>	①: 0.1 to 1,000 mg/L NH ₃ ②: Adjust more than pH 12 ③: 0 to 50°C ④: Within 30 seconds when substituting low concentration to high concentration Within 2 minutes when substituting high concentration to low concentration	—	—
Sodium ion electrode 1512A-10C  <p>3014068526 (9003016700)</p>	①: 2.3 to 230,000 mg/L Na ⁺ (10 ⁻⁴ to 10 mol/L Na ⁺) ②: 230 mg/L (10 ⁻² mol/L) Na ⁺ Over pH 4.5 ③: 0 to 60°C ④: Within 30 seconds *1	2565A	K ⁺ , Li ⁺ = 10 NH ₄ ⁺ = 20 Ca ²⁺ = 500
Nitrate ion electrode (combination) 6581-10C  <p>3014093432 (9003014700)</p>	①: 0.62 to 62,000 mg/L NO ₃ ⁻ (10 ⁻⁵ to 1 mol/L NO ₃ ⁻) ②: 62 mg/L (10 ⁻³ mol/L) NO ₃ ⁻ pH 3 to 7 ③: 0 to 50°C ④: Within 15 seconds *2	—	ClO ₄ ⁻ = 0.03 I ⁻ = 0.1 Br ⁻ = 2 NO ₂ ⁻ = 3 Cl ⁻ = 40 F ⁻ = 200 CH ₃ COO ⁻ = 300 SO ₄ ²⁻ = over 1,000
Nitrate ion electrode 8201-10C  <p>3014094403 (9003016800)</p>	①: 0.62 to 62,000 mg/L NO ₃ ⁻ (10 ⁻⁵ to 1 mol/L NO ₃ ⁻) ②: 62 mg/L (10 ⁻³ mol/L) NO ₃ ⁻ pH 3 to 7 ③: 0 to 50°C ④: Within 15 seconds *2	2565A	ClO ₄ ⁻ = 0.03 I ⁻ = 0.1 Br ⁻ = 2 NO ₂ ⁻ = 3 Cl ⁻ = 40 F ⁻ = 200 CH ₃ COO ⁻ = 300 SO ₄ ²⁻ = over 1,000
Potassium ion electrode (combination) 6582-10C  <p>3014093433 (9003014800)</p>	①: 0.04 to 39,000 mg/L K ⁺ (10 ⁻⁶ to 1 mol/L K ⁺) ②: 3.9 mg/L (10 ⁻⁴ mol/L) K ⁺ pH 5 to 11 ③: 0 to 50°C ④: Within 15 seconds *3	—	Rb ⁺ = 0.4 Cs ⁺ = 3 NH ₄ ⁺ = 70 Li ⁺ , Na ⁺ , Mg ²⁺ , Ca ²⁺ , Sr ²⁺ , Ba ²⁺ = over 1,000

ION ELECTRODES

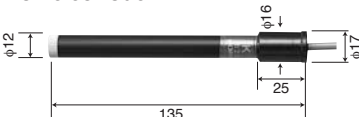
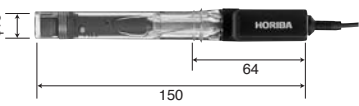
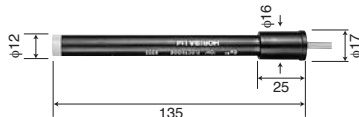
Type	Measuring range	Applicable reference electrode	Selection coefficient
Potassium ion electrode 8202-10C 	①: 0.04 to 39,000 mg/L K ⁺ (10 ⁻⁶ to 1 mol/L K ⁺) ②: 3.9 mg/L (10 ⁻⁴ mol/L) K ⁺ pH 5 to 11 ③: 0 to 50°C ④: Within 15 seconds *3	2565A	Rb ⁺ = 0.4 Cs ⁺ = 3 NH ₄ ⁺ = 70 Li ⁺ , Na ⁺ , Mg ²⁺ , Ca ²⁺ , Sr ²⁺ , Ba ²⁺ = over 1,000
Calcium ion electrode (combination) 6583-10C 	①: 0.4 to 40,080 mg/L Ca ²⁺ (10 ⁻⁵ to 1 mol/L Ca ²⁺) ②: 4.0 mg/L (10 ⁻⁴ mol/L) Ca ²⁺ pH 5 to 11 ③: 0 to 50°C ④: Within 15 seconds *4	—	Fe ³⁺ = 0.1 Fe ²⁺ , Zn ²⁺ = 1 Sr ²⁺ = 50 Ni ²⁺ , Cu ²⁺ = 70 Co ²⁺ = 350 Mn ²⁺ = 500 Mg ²⁺ = 1,000 Na ⁺ , K ⁺ , Ba ²⁺ , NH ₄ ⁺ = over 1,000
Calcium ion electrode 8203-10C 	①: 0.4 to 40,080 mg/L Ca ²⁺ (10 ⁻⁵ to 1 mol/L Ca ²⁺) ②: 4.0 mg/L (10 ⁻⁴ mol/L) Ca ²⁺ pH 5 to 11 ③: 0 to 50°C ④: Within 15 seconds *4	2060A, 2565A	Fe ³⁺ = 0.1 Fe ²⁺ , Zn ²⁺ = 1 Sr ²⁺ = 50 Ni ²⁺ , Cu ²⁺ = 70 Co ²⁺ = 350 Mn ²⁺ = 500 Mg ²⁺ = 1,000 Na ⁺ , K ⁺ , Ba ²⁺ , NH ₄ ⁺ = over 1,000

•Sensor holder is necessary for ion electrode except of combination type to attach to electrode stand.

•The response time is the time which is required to reach 90% response when the ion concentration is gradually changed from 10⁻⁴ mol/L to 10⁻² mol/L with the solution stirred.

Exception:

*1: 90% response when ion concentration is changed to 10⁻⁶ mol/L ~ 10⁻² mol/L

*2: 95% response when ion concentration is changed to 10⁻³ mol/L ~ 10⁻¹ mol/L

*3: 95% response when ion concentration is changed to 10⁻⁴ mol/L ~ 10⁻² mol/L

*4: 95% response when ion concentration is changed to 10⁻⁴ mol/L ~ 10⁻¹ mol/L

•The selection coefficient is a ratio of the limit concentration of coexisting ions (mol/L) to the ion concentration to be measured (mol/L); The value of 1000 means that the coexisting ions can be permitted up to 1000 times the ion measured and "not acceptable" means that chemical change occurs in the solid response membrane.

Cartridges for Ion Sensor

Type	Feature
7660 Chloride ion cartridge 3014093436(9003015000)	Replacement electrode tip for combination or single electrodes
7661 Fluoride ion cartridge 3014093438(9003015100)	
7681 Nitrate ion cartridge 3014068364(9003015200)	
7682 Potassium ion cartridge 3014069795(9003015300)	
7683 Calcium ion cartridge 3014068795(9003015400)	
Membrane(NH₃) 3014067083(9012001000)	Membrane set (6 pcs) for NH ₃ electrodes
370 Internal solution for NH₃ electrodes 3014067184(9012000900)	Contains 250 mL
O-ring 3200043723(9012001100)	Neoprene ring set (10 pcs) for NH ₃ electrodes (JIS B 2401-P7)

CONDUCTIVITY ELECTRODE CELLS

Conductivity is calculated as the inverse of the resistance R(in ohms) of the sample solution as $S/m = V/m$ between two parallel electrode plates with a surface area of $1m^2$ separated by a distance of 1m. Since conductivity changes depending on temperature of the sample solution, values are shown at the standard temperature equivalent of 25°C. HORIBA's conductivity electrodes also have a built-in thermistor for temperature measurement, making them perfect for temperature measurement and for obtaining values equivalent to those at the standard 25C, when used in conjunction with the conductivity meter. Since the conductivity gives valuable information about the ion composition of the sample solution, it is expected that these useful electrodes will continue to find a wide range of applications in the future.

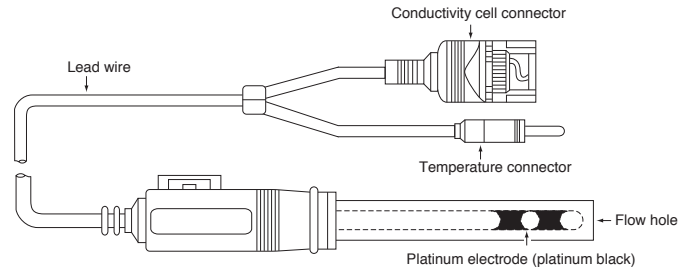

Conductivity Cells (Submersible Type)

(*1) The cell constants are within 10% of the values shown.

Type	Cell constant (cm ⁻¹)	Measuring range	Sample amount required (mL)	Temperature compensation element	Applicable temperature range(°C)	Remarks
3551-10D 3014081712 (9056000800)	0.1	10 μS/m to 1 S/m (0.1 μS/cm ~10 mS/cm)	50	Incorporated	0-60	For low conductivity water (deionized water or other)
3552-10D 3014081545 (9056000900)	1	0.1 mS/m to 10 S/m (1 μS/cm ~100 mS/cm)	15	Incorporated	0-100	For general purposes (provided as a standard accessory for the DS-10 series)
3553-10D 3014081714 (9056001000)	10	1 mS/m to 100 S/m (10 μS/cm ~1 S/cm)	50	Incorporated	0-60	For high conductivity water
9382-10D 3014046709 (9096000300)	1	0.1 mS/m to 10 S/m (1 μS/cm ~100 mS/cm)	20-30	Incorporated	0-80	Waterproof. For general purposes.

Conductivity Cells (Flow Type)

(*1) The cell constants are within 10% of the values shown.

Type	Cell constant (cm ⁻¹)	Measuring range	Sample amount required (mL)	Temperature compensation element	Applicable temperature range(°C)	Remarks
3561-10D 3014082350 (9056001100)	0.1	10 mS/m to 1 S/m (0.1 μS/cm ~10 mS/cm)	10	Incorporated	0-60	For low conductivity water (pure water or other)
3562-10D 3014082513 (9056001200)	1	0.1 mS/m to 10 S/m (1 μS/cm ~100 mS/cm)	16	Incorporated	0-60	For general purposes
3573-10C 3014082590 (9056001300)	10	1 mS/m to 100 S/m (10 μS/cm ~1 S/cm)	4	Not provided	0-60	For high conductivity water
3574-10C 3014082592 (9056001400)	10	1 mS/m to 10 S/m (10 μS/cm ~100 mS/cm)	0.25	Not provided	0-80	For column chromatography using a very small amount of sample

DISSOLVED OXYGEN(DO) ELECTRODE & TIPS

Dissolved Oxygen(DO) electrode detect oxygen that diffuses through the oxygen-permeable membrane to determine the amount of dissolved oxygen. The method for measuring dissolved oxygen based on this principle is referred to as the diaphragm electrode method. DO measurement can be carried out much more simply than chemical analysis, which requires complex preparatory procedures to eliminate the effects of deoxidized and oxidized substances. HORIBA's DO electrodes use innovative disposable probe tips. This eliminates the troublesome replacement of membranes and fluid that plagued conventional methods. Each disposable tip comes with its own rotor, so it is not necessary to prepare a separate rotor for each sample. In addition, the electrode has an adaptor for easy use with an incubator in BOD measurement.

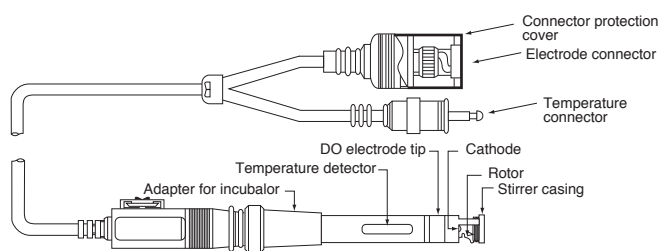

Dissolved Oxygen Electrodes

Type	Applicable temperature range(°C)	Measuring range	Response time	Feature
9520-10D For laboratories 3014046711 (9096000500)	0-45	DO: 0-19.99mg/L Temperature: 0-40°C (When used with dissolved D-25)	20 seconds (90% response time at constant temperature)	Waterproof. Uses a thermistor with a disposable ship-type electrode 7541 as the thermometric element.
9551-20D For field immersible type (2 m cable) 3014047090 (9096002300)	0-40	DO: 0-19.99mg/L Temperature: 0-40°C (When used with dissolved D-55, OM-51)	30 seconds (90% response time at constant temperature)	Waterproof. Uses a thermistor with a disposable ship-type electrode 5401 as the thermometric element.
9551-100D For field immersible type (10 m cable) 3014047091 (9096002400)	0-40	DO: 0-19.99mg/L Temperature: 0-40°C (When used with dissolved D-55, OM-51)	30 seconds (90% response time at constant temperature)	Waterproof. Uses a thermistor with a disposable ship-type electrode 5401 as the thermometric element.







Dissolved Oxygen Electrode Tips

•A commercially available stirrer should be used.



Type	Remarks
5401 3014072770 (9033010000)	A DO electrode chip for replacement. (For the above-mentioned 9551-20D, 9551-100D, 9550-20D, 9550-100D, 5450-20D and 5450-100D)
7541 3014074145 (9074000200)	A DO electrode chip for replacement. (For the above-mentioned 5410-10C, 9520-10D)

ACCESSORIES







For Electrode

<p>Sensor holder (2 pcs/pack)</p> <p>3200373961</p>  <p>For attaching an ion electrode or the like with a round electrode cap to the stand arm.</p>	<p>9621, 9625 Electrode protector tube (5 pcs/pack)</p> <p>3200044409(9003012000)</p>  <p>Protects the tip of the 9621-10D, 9625-10D electrode. Because the electrode is already encased in a plastic sheath, just slip this protective tube over the tip and your pH meter is ready to for work in the field.</p>	<p>Electrode protector cap (5 pcs/pack)</p> <p>3200043508(9003012100)</p>  <p>Protects electrodes during storage or transportation.</p>
<p>Electrode protector cap (3 pcs/pack)</p> <p>3200382477</p>  <p>Protects electrodes during storage or transportation for 9615-10D, 9618-10D, 9681-10D.</p>	<p>Electrode protector cap for long electrode</p> <p>32000382482</p>  <p>Protects electrodes during storage or transportation for 9680-10D and 9678-10D.</p>	<p>Plug for internal solution filler port (3 pcs/pack)</p> <p>3200382468</p>  <p>For 9615-10D, 9618-10D, 9681-10D, 9680-10D.</p>



For F-70, DS-70, F-50, D-50, DS-50, ES-50, OM-50, F-20, F-10 Series

<p>Digital simulator X-51</p>  <p>pH, mV, ION, DO simulator (for periodic inspection of the electrode)</p>	<p>Digital simulator X-52</p>  <p>Conductivity simulator (for periodic inspection of the electrode)</p>
---	--

For F-70, DS-70, F-50, D-50, DS-50, ES-50, OM-50 Series







<p>Printer (for GLP/GMP compliance)</p> <p>CBM-910-24RJ100-A</p>  <p>There are printers for 100V, 120V and 230V power supplies. Please consult our sales staff when ordering 120V and 230V models.</p> <p>The model numbers for 120V and 230V are listed below. 120V: CBM-910-24RJ-120-A (3014030146) 230V: CBM-910-24RJ-230-A (3014030147)</p>	<p>Printer cable</p> <p>3014030148(9096003800)</p>  <p>Cable to connect Printer with 50 series and 70 series.</p>	<p>Printer paper</p> <p>3014030149(9096003900)</p>  <p>20 rolls</p>	<p>Ink ribbon</p> <p>3014030150(9096004000)</p>  <p>5 pcs/set</p>
<p>AC adaptor cable set.</p>  <p>AC adaptor 1.8m cable 1m</p> <p>120V: 3014031951 230V: 3014031952</p>	<p>Serial cable</p> <p>3014030151(9096004800)</p>  <p>Cable to connect a meter and PC (Serial, 9 pins)</p>		

For F-70, DS-70 Series

<p>LCD protection sheet (2 pcs/pack)</p> <p>3200382462</p> <p>For F-70, DS-70 series</p> 	<p>Protection cover</p> <p>3200382441</p>  <p>Protects the meter for F-70, DS-70 series</p>	<p>USB cable</p> <p>3200373941</p>  <p>Cable to connect a meter and PC.</p>
---	--	---

ACCESSORIES

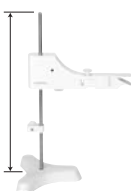
Electrode stands

<p>Electrode stand for F-50/DS-50</p> <p>3014028342 (9096002600)</p> <p>For F-50, DS-50</p> 	<p>FA-70L Electrode stand (long type)</p> <p>3200382560</p> <p>650mm</p>  <p>Electrode stand (adjustable type)</p>	<p>DP-50S Electrode stand</p> <p>3014028590 (9096002700)</p> <p>For D-50, ES-50, OM-50</p>  <p>*meter and electrode are not included</p>	<p>Arm, for electrode stand</p> <p>3014030158 (9096002800)</p>  <p>For "DP-50S", "FA-50S" and "Electrode stand for F-50/DS-50"</p>
<p>FA-70S Electrode stand (adjustable type)</p> <p>3200382557</p> <p>384mm</p>  <p>Electrode stand</p>	<p>Arm, for electrode stand (adjustable type)</p> <p>3200373991</p>  <p>For FA-70S, FA-70L and FA-20S. Also available for FA-50S and "Electrode stand for F-50/DS-50"</p>		

■ **Dimension** Unit: mm

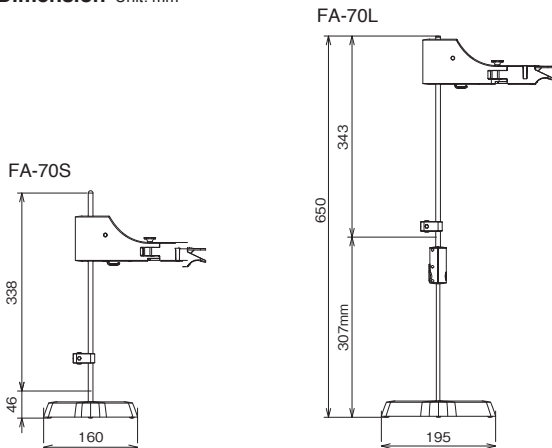

Accessories

<p>Connector cover</p> <p>3014030159 (9096002900)</p>  <p>For D-50, ES-50, OM-50</p>	<p>Strap</p> <p>3014030156 (9096005200)</p>  <p>For D-50, ES-50, OM-50</p>	<p>Soft case</p> <p>3014030153 (9096005100)</p>  <p>For D-50, ES-50, OM-50</p>	<p>COMPACTFLASH® memory card</p> <p>3014030160 (9096003000)</p>  <p>For F-53, 54, 55</p>	<p>Analog (alarm) output cable</p> <p>3014030152 (9096004900)</p> <p>For F-52, 53, 54, 55 and DS-52, F-72, F-73, F-74, DS-72</p>
--	--	--	--	---

* COMPACTFLASH is a trademark of San Disk Corporation

Maintenance Parts for Obsolete Models

<p>Output cord</p> <p>3200044408 (9078000200)</p> <p>Connect a recorder to make easy work of data analysis after measurement. Applicable models: D-20, 10, OM-10 and D-10 series</p>	<p>AC-10 AC adapter</p> <p>3200044196 (9078000100)</p> <p>Applicable models: D-20, F-20, ES-10, OM-10, D-10 and DS-10 series</p>	<p>Printer paper (10 rolls)</p> <p>3200043956 (9079000400)</p> <p>Applicable models: F-15, 16, DS-15, and F-20 series</p>	<p>Dual electrode holder</p> <p>3200043613 (9096001100)</p>  <p>Applicable model: D-20 series Adaptor for fitting two electrodes</p>
---	---	--	--

STANDARD SOLUTIONS, INTERNAL SOLUTION for REFERENCE ELECTRODE & CLEANING SOLUTIONS

pH Standard Solution SET (accuracy: ± 0.02 pH)

Type	Name	pH value(25°C)	Volume(mL)	Remarks
 101-S 3200043642 (9003003500)	Phosphate standard equimolal solution	6.86	500	Use undiluted. The set contains standard and internal solutions, as shown.
	Phthalate standard solution	4.01	250	
	Borate standard solution	9.18	250	
	Internal Solution for Reference Electrode (300)	—	250	

pH Standard Solution (accuracy: ± 0.02 pH)

Type	Name	pH value(25°C)	Volume(mL)	Remarks	
 100-2 3200043639 (9003001500)	Oxalate standard solution	1.68	500	The original solution should be used as it is. For general use as standard solution sets, 101-S (100-4.7.9 and #310 internal solution) are also available.	
	100-4 3200043638 (9003001600)	Phthalate standard solution	4.01		500
	100-7 3200043637 (9003001700)	Phosphate standard equimolal solution	6.86		500
	100-9 3200043636 (9003001800)	Borate standard solution	9.18		500
	100-10 3200043635 (9003001900)	Carbonate standard solution	10.02		500

Condensed pH Standard Solution (accuracy: ± 0.02 pH)

Type	Name	pH value(25°C)	Volume(mL)	Remarks	
 110-4 3200043626 (9003002300)	Condensed phthalate standard solution	4.01	500	Should be diluted when used. The pH values shown are those obtained when the original solution is diluted with pure water at a volume ratio of 1 to 4. For general use.	
	110-7 3200043625 (9003002400)	Condensed phosphate standard equimolal solution	6.86		500
	110-10 3200043624 (9003002500)	Condensed carbonate standard solution	10.02		500

Standard Solution for Accurate Measurements (N.B.S., accuracy: ± 0.003 pH)

Type	Name	pH value		Volume(mL)	Remarks	
		25°C	37°C			
 100-B4 3200043630 (9003002000)	Phthalate standard solution	4.008	4.030	500	The original solution should be used as it is. This standard solution is for very accurate measurements based on N.B.S. The pH values shown do not necessarily match with those shown in JIS.	
	100-B7 3200043631 (9003002100)	Phosphate standard solution	7.413	7.383		500
	100-B9 3200043632 (9003002200)	Borate standard solution	9.180	9.082		500

Powder for pH Standard Solution (accuracy: ± 0.05 pH)

Type	Name	pH value(25°C)	Remarks	
 150-4 3200043619 (9003002700)	Powder for phthalate standard solution	4.01	The pH value shown are those obtained when one packet is dissolved in 500 ml of pure water. One packet contains powder for 500 mL. For use in field at factories (10 packets per set)	
	150-7 3200043620 (9003002800)	Powder for neutral phosphate standard solution		6.86
	150-9 3200043621 (9003002900)	Powder for borate standard solution		9.18

Powder for ORP Standard Solution (accuracy: ± 15 mV)

Type	Name	ORP value(25°C)	Remarks
 160-51 3200043618 (9003003100)	Powder for ORP standard solution	89 mV (vs. 3.33 mol/L KCl-AgCl)	The ORP values shown are those obtained when one packet is dissolved in 250 mL of pure water. This standard solution should be used immediately after conditioning and can-not be used for 2 hours or more. (10 packets per set)
	160-22 3200043617 (9003003000)	Powder for ORP standard solution	

Note: The pH standard solution by a reliable manufacturer should be selected because they are used as reference for pH measurements. It is recommended for safety not to use the standard liquid which was allowed to stand for long hours after opening its bottle or which was once used.

Internal Solution for Reference Electrode

Type	Name	Concentration	Volume(mL)	Remarks
 300 3200043640 (9003003200)	For 6327, 6328, F, M, and D-10 series electrodes	3.33 mol/L KCl	250	The original solution should be used as it is. Powder for internal solution (350) is also available for a large amount of internal solution. (The powder is used by dissolving it in pure water.)
	310 3200043622 (9003003300)	For H-7 and old type pH meter electrodes	3.33 mol/L KCl (AgCl, saturation in normal temp.)	

Powder for Internal Solution for Reference Electrode

Type	Remarks
 350 3200043623 (9003003400)	500g. Dissolve in 2L of pure water.

Electrode Cleaning Solution









Type	Name	Volume(mL)	Remarks
 220 3014028653 (9096002500)	Electrode cleaning solution	50 x 2 pcs	For removing inorganic sample residues from glass electrodes, and for cleaning liquid junctions
	250 3200366771	Electrode cleaning solution	400

ACCESSORIES for U-50, U-20XD, U-10, W-20XD SERIES & INTERNAL SOLUTION for REFERENCE ELECTRODE

U-50 Series Accessories

pH sensor 7112 3014057312(90370048000)	pH sensor T_{cupH} 7113 3200170923	ORP sensor 7313 3200170920	DO sensor 7543 3200170924	Reference sensor 7210 3200043582(90370050000)
Reference tip for 7210 3200043587(90370051000)	Turbidity sensor 7800 for U-52/U-52G 3200172803	Turbidity sensor 7801 for U-53/U-53G 3200172800	Turbidity sensor 7802 for U-54/U-54G 3200318188	DO membrane cap for U-50 series 3200170194
DO inner fluid 306 50 mL 3200170938				



U-20XD/W-20XD Series Sensors

pH sensor 6230 for U-21/22/23, W-22/23 3014050849(9037005600)	Dissolved oxygen sensor 5460 for U-21/22/23, W-22/23 3014001152(9037005800)	Chloride ion sensor * 6522 for W-23 3014050860(9037006000)
		
Fluoride ion sensor * 6530 for W-23 3014050859(9037006300)	Ammonia sensor 5012 for W-23 3014050864(9037006200)	pH/ORP sensor 6280 for U-22, W-22/23 3014050850(9037005700)
		
Nitrate ion sensor * 6531 for W-23 3014050863(9037005900)	Calcium ion sensor * 6533 for W-23 3014050861(9037006100)	Potassium ion sensor * 6532 for W-23 3014050862(9037006400)
		

* Ion selective electrode cartridge included.

#5460 membrane replace kit (50 times) 3014050853(9037007400)	#5012 membrane replace kit (6 units/set) 3014001155(9037007000)
--	---

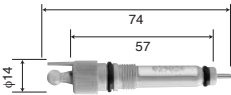
U-10 Electrode Tips

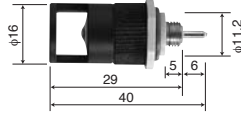





pH Electrode Tip 7112 3014057312(9037004800)		Reference Electrode Tip 7210 3200043582(9037005000)	
Reference electrode internal solution 330 3200043641(9037005200) 3.33 mol/L KCL Gel type 250 mL	Liquid junction 3200043587(9037005100) For 7210 2 units/set		
Do Tip 7542 3014057313(9037004900)			
Calibration beaker 3200043588(9037005300)			

Internal Solution for Reference Electrode

300 3200043640(9033003200) Reference electrode internal solution for nitrate ion (250 mL)	301 3014001271(9037006700) Reference electrode internal solution for chloride (50 mL)	302 3014001273(9037006600) Reference electrode internal solution for calcium/fluoride (50 mL)	303 3014001272(9037006900) Reference internal solution for potassium (50 mL)
370 3014067184(9012000900) Reference internal solution for ammonia (250 mL)	Calibration beaker 3014001156(9037007300) U-20 For automatic calibration		

ELECTRODES & ACCESSORIES for TWIN/CARDY

SENSOR and ACCESSORIES for LAQUAtwin/TWIN/CARDY

Type	Sample amount required	Measuring temperature	Applicable model	Remarks
S010 LAQUAtwin/TWIN pH sensor  3200459834	Approx. 0.1 mL	5 to 40°C	B-211/B-212 B-213/B-711 B-712/B-713	Liquid junction :Porous macromolecule Glass electrode and reference electrode integrated on a 1mm-thick substrate. Replacement flat type pH sensor.
S021 LAQUAtwin Salt sensor  3200459866	Approx. 0.3 mL	5 to 40°C	B-721	Liquid junction :Porous macromolecule Replacement flat type salt sensor. This sensor respond to sodium ion.
S022 LAQUAtwin Sodium ion sensor  3200459867	Approx. 0.3 mL	5 to 40°C	B-722	Liquid junction :Porous macromolecule Replacement flat type Sodium ion sensor.
S030 LAQUAtwin Potassium ion sensor  3200459868	Approx. 0.3 mL	5 to 40°C	B-731	Liquid junction :Porous macromolecule Replacement flat type Potassium ion sensor.
S040 LAQUAtwin Nitrate ion sensor  3200459870	Approx. 0.3 mL	5 to 40°C	B-341/B-342 B-343/B-741 B-742/B-743	Liquid junction :Porous macromolecule Replacement flat type Nitrate ion sensor.
S050 LAQUAtwin Calcium ion sensor  3200459869	Approx. 0.3 mL	5 to 40°C	B-751	Liquid junction :Porous macromolecule Replacement flat type Calcium ion sensor.
S070 LAQUAtwin Conductivity sensor  3200459672	Approx. 0.12 mL	5 to 40°C	B-771	Replacement flat type Conductivity sensor.





Exclusively for TWIN Conductivity Cell

Type	Measuring range	Cell capacity	Measuring temperature	Temperature compensation element	Remarks
0413 (for B-173)  3014088578(9088000400)	0 to 19.9mS/cm	Approx. 0.1 mL	5 to 35°C	Incorporated	For B-173 (conductivity meter) only. Cannot be applied for B-771.

Exclusively for CARDY Ion Electrode

















Type	Measuring range	Sample amount required	Measuring temperature	Liquid junction	Remarks
Sodium ion electrode 0221 (for C-121 and C-122) 3014081704(9076003000)	0.1% (w/w) to 10% (w/w) NaCl	Approx. 0.1 mL	5 to 35°C	Porous macromolecule	For C-121,C-122 (Salt,Sodium ion meter) only. Cannot be applied for B-721,B-722.
Potassium ion electrode 0231 (for C-131) 3014083433(9076007200)	39 to 3,900 mg/L	Approx. 0.1 mL	5 to 35°C	Porous macromolecule	For C-131 (Potassium ion meter) only. Cannot be applied for B-731.
Nitrate ion electrode 0241 (for C-141) 3014083435 (9076007600)	62 to 6,200 mg/L	Approx. 0.1 mL	5 to 35°C	Porous macromolecule	For C-141 (Nitrate ion meter) only. Cannot be applied for B-340 series & B-740 series.

Accessories

Type	specification	Remarks
Y047 Sampling sheet holder  3200053995	For B-342(for soil) /replacement sensor(0243) *Cannot be applied for LAQUAtwin B-700 series and their replacement sensors(S010/S021/S022/S030/S040/S050)	For a sample that contain particulate such as soils,suspension. To be used with "Sampling sheet B (model Y046)"
Y048 Sampling sheet holder  3200459736	For LAQUAtwin B-700 series and their replacement sensors(S010/S021/S022/S030/S040/S050) *Cannot be applied for B-342(for soil) /replacement sensor(0243)	For a sample that contain particulate such as soils,suspension. To be used with "Sampling sheet B (model Y046)"
Y046 Sampling sheet B  3200053858	100 sheets For LAQUAtwin/TWIN series	For trace measurement(0.05 mL),wiping measurement. If a sample that contain particulate, please use *Y047 : twin series/Y048 : LAQUAtwin series
Y011A Sampling sheet C  3014053435	11 mm x 6 mm x 5 rolls For CARDY series	For trace measurement(0.05 mL),wiping measurement.
Y049 Crop sample press  3200469679	For squeezing a sample such as crop	Standard accessory for B-341, B-741

ELECTRODES & ACCESSORIES for TWIN/CARDY

Standard solution

Type		Value	Volume	Applicable model	Remarks
Y017 Standard solution (pH 6.86) 3200457725		pH 6.86	14 mL 6 bottles	B-711/B-712 B-211/B-212	Replacing model of Y031 (discontinued)
Y014 Standard solution (pH 4.01) 3200457726		pH 4.01	14 mL 6 bottles	B-712/B-212	Replacing model of Y032 (discontinued)
Y021H Standard solution (NaCl 5.0%) 3200457721		NaCl 5.0%	14 mL 6 bottles	B-721/C-121	Replacing model of Y022(discontinued) *To be used with Y021L for two-point calibration
Y021L Standard solution (NaCl 0.5%) 3200457722		NaCl 0.5%	14 mL 6 bottles	B-721/C-121	Replacing model of Y022(discontinued) *To be used with Y021H for two-point calibration
Y022H Standard solution (Sodium Ion 2000ppm) 3200457723		Sodium Ion 2000ppm	14 mL 6 bottles	B-722/C-122	Replacing model of Y024(discontinued) *To be used with Y022L for two-point calibration
Y022L Standard solution (Sodium Ion 150ppm) 3200457724		Sodium Ion 150ppm	14 mL 6 bottles	B-722/C-122	Replacing model of Y024(discontinued) *To be used with Y022H for two-point calibration
Y031H Standard solution (Potassium Ion 2000ppm) 3200457719		Potassium Ion 2000ppm	14 mL 6 bottles	B-731/C-131	Replacing model of Y025(discontinued) *To be used with Y031L for two-point calibration
Y031L Standard solution (Potassium Ion 150ppm) 3200457720		Potassium Ion 150ppm	14 mL 6 bottles	B-731/C-131	Replacing model of Y025(discontinued) *To be used with Y031H for two-point calibration
Y041 Standard solution (Nitrate Ion 5000ppm) 3200053433		Nitrate Ion 5000ppm	14 mL 6 bottles	B-741/B-341	
Y042 Standard solution (Nitrate Ion 300ppm) 3200053514		Nitrate Ion 300ppm	14 mL 6 bottles	B-741/B-742 B-341/B-342	
Y043 Standard solution (Nitrate Ion 2000ppm) 3200053532		Nitrate Ion 2000ppm	14 mL 6 bottles	B-743/B-343 C-141	Replacing model of Y026(discontinued) *To be used with Y045 for two-point calibration
Y044 Standard solution (Nitrate Ion 30ppm) 3200053535		Nitrate Ion 30ppm	14 mL 6 bottles	B-742/B-342	
Y045 Standard solution (Nitrate Ion 150ppm) 3200053536		Nitrate Ion 150ppm	14 mL 6 bottles	B-743/B-343 C-141	Replacing model of Y026(discontinued) *To be used with Y043 for two-point calibration
Y051H Standard solution (Calcium Ion 2000ppm) 3200457727		Calcium Ion 2000ppm	14 mL 6 bottles	B-751	
Y051L Standard solution (Calcium Ion 150ppm) 3200457728		Calcium Ion 150ppm	14 mL 6 bottles	B-751	
Y071H Standard solution (Conductivity 12.9mS/cm) 3200457718		Conductivity 12.9mS/cm	14 mL 6 bottles	B-771	
Y071L Standard solution (Conductivity 1.41mS/cm) 3200457717		Conductivity 1.41mS/cm	14 mL 6 bottles	B-771/B-173	Replacing model of Y023(discontinued) *To be used with Y071H for two-point calibration (Only B-771)

HORIBA WATER QUALITY ANALYZER LINEUP

Benchtop pH/Water Quality Analyzer F-70 series LAQUA

- Intuitive and very easy to use touch panel operation and navigation
- USB PC Communication and USB memory
- Full support for various country pharmaceutical pure water guidelines (USP/EP/JP/CP)
- Multi-language support (Japanese, English, Chinese, Korean)
- Enhanced data reliability with validation features (GLP/GMP compliance)



pH
mV(ORP)
ION
COND
DO
RESI
SAL
TDS

Benchtop DS-70 series LAQUA

- Intuitive and very easy to use touch panel operation and navigation
- USB PC Communication and USB memory
- Full support for various country pharmaceutical pure water guidelines (USP/EP/JP/CP)
- Multi-language support (Japanese, English, Chinese, Korean)
- Enhanced data reliability with validation features (GLP/GMP compliance)



COND
RESI
SAL
TDS

Portable pH METER D-50 Series NAVI

- Revolutionary waterproof meter and electrodes enhance care-free operation in the lab or field
- Quick connection to PC allows easy and fast data evaluation
- Portable multi-parameter meter allows measurement of up to 4 parameters
- Automatic data-logging function
- Self diagnostic function assures reliable measurement



pH
ORP
ION
COND
DO

Portable CONDUCTIVITY METER ES-51 NAVI

- Revolutionary waterproof meter and electrodes enhance care-free operation in the lab or field
- Quick connection to PC allows easy and fast data evaluation
- Automatic data-logging function
- Self diagnostic function assures reliable measurement



COND
RESI
SAL

Portable DO METER OM-51 NAVI

- Revolutionary waterproof meter and electrodes enhance care-free operation in the lab or field
- Quick connection to PC allows easy and fast data evaluation
- Automatic data-logging function
- Self diagnostic function assures reliable measurement



DO
Oxygen Saturation
Oxygen

Portable Multiparameter Water Quality Checker U-50 series

- Ideal for water quality testing and inspection of river, lake, well water, groundwater, discharge water and other water sources
- Simultaneous measurement and display of up to 11 parameters
- Integrated sensor probe and display section for maximum portability
Convenient for one-point measurement and measurements near the surface of the water. Built-in highly sensitive turbidity sensor enables measurement of even low turbidity water



pH
ORP
COND
SAL
TDS
DO
TURB
DEPTH
TEMP
GPS

Water Quality Monitoring System

Portable W-20XD Series

- Ideal for water quality testing and inspection of, city sewage water, lakes and marshes, dams, wells and ground water, factory drainage, farm water, and nurseries
- Simultaneous measurement and display of up to 13 parameters
- Up to one month data logging (With measurements every 15 minutes)
- Measurement at depths as low as 100 meters with its superior durability and high pressure resistance



pH
ORP
COND
SAL
TDS
DO
TURB
DEPTH
TEMP
ION

HORIBA WATER QUALITY ANALYZER LINEUP

Compact pH METER B-711/B-712/B-713 LAQUAtwin

- Flat sensor technology realizes a reliable and direct measurement of a drop of the sample from 0.1 mL
- Select measurement method depending on your situation and sample. (Drops, Immersion, Scoop, Wipe, Solid samples, Powders, Paper, textiles)
- IP67 waterproof and dustproof
- Temperature compensation/Auto hold

B-711 (One-point calibration)

B-712 (Two-point calibration)

B-713 (US only) (Two-point calibration)



pH

pH

Compact Compact Conductivity METER B-771 LAQUAtwin

- Flat sensor technology realizes a reliable and direct measurement of a drop of the sample from 0.12 mL
- Conductivity readings can be converted into Salt and TDS
- IP67 waterproof and dustproof
- Temperature compensation/Auto hold/Auto range change



COND
Salt
TDS

COND

Compact Sodium Ion METER B-722 LAQUAtwin

- Only compact meter for a quick measurement of sodium ion using ion selective membrane
- Flat sensor technology realizes a reliable and direct measurement of a drop of the sample from 0.3 mL
- IP67 waterproof and dustproof
- Temperature compensation/Auto hold/Auto range change



ION

Na⁺

Compact Potassium Ion METER B-731 LAQUAtwin

- Only compact meter for a quick measurement of potassium ion using ion selective membrane
- Flat sensor technology realizes a reliable and direct measurement of a drop of the sample from 0.3 mL
- IP67 waterproof and dustproof
- Temperature compensation/Auto hold/Auto range change



ION

K⁺

Compact Nitrate Ion METER B-741/B-742/B-743 LAQUAtwin

- Only compact meter for a quick measurement of Nitrate ion using ion selective membrane
- Flat sensor technology realizes a reliable and direct measurement of a drop of the sample from 0.3 mL
- IP67 waterproof and dustproof
- Temperature compensation/Auto hold/Auto range change
- Special application packages for crop and soil

B-741 (for crops)

B-742 (for soil)

B-743 (for general use)



ION

NO₃⁻

Compact Calcium Ion METER B-751 LAQUAtwin

- Only compact meter for a quick measurement of Calcium ion using ion selective membrane
- Flat sensor technology realizes a reliable and direct measurement of a drop of the sample from 0.3 mL
- IP67 waterproof and dustproof
- Temperature compensation/Auto hold/Auto range change



ION

Ca²⁺

Compact Salt METER B-751 LAQUAtwin

- Only compact meter to measure sodium ion to calculate into NaCl based salt concentration unlike the conductivity converted meters
- Flat sensor technology realizes a reliable and direct measurement of a drop of the sample from 0.3 mL
- IP67 waterproof and dustproof
- Temperature compensation/Auto hold/Auto range change



ION

Salt

WATER QUALITY ANALYZERS website

Horiba 60 years engineering realizes lineup various of water quality analyzers and electrodes for any laboratory use. "Water quality analyzer website" introduces HORIBA lab water quality analyzers and electrodes and provide many services such as manual download or water quality measurement tips.

<http://www.horiba.com/wq>



LAQUA website

Taking your comments and feedback to our heart,"LAQUA" is our new brand to deliver you our best solution to your needs. "LAQUA" website introduces case of solutions with LAQUA and innovative pH electrodes.

<http://www.horiba.com/laqua>



LAQUAtwin website

Water quality will be more familiar with you by LAQUAtwin. Whoever ,whenever, wherever be able to measure easily with LAQUAtwin. "LAQUAtwin website" introduces the charm of LAQUAtwin.

<http://www.horiba.com/laquatwin>



Please read the operation manual before using this product to assure safe and proper handling of the product.

- The contents of this catalog are subject to change without prior notice, and without any subsequent liability to this company.
- The color of the actual products may differ from the color pictured in this catalog due to printing limitations.
- It is strictly forbidden to copy the content of this catalog in part or in full.
- All brand names, product names and service names in this catalog are trademarks or registered trademarks of their respective companies.

<http://www.horiba.com> e-mail: info@horiba.co.jp

●HORIBA, Ltd.

Head Office
2 Miyanohigashi, Kisshoin
Minami-ku, Kyoto, Japan
Phone: 81 (75) 313-8123
Fax: 81 (75) 321-5725

Tokyo Sales Office
Kanda-Awaji-cho Nichome
Building 2-6, Awaji-cho,
Kanda, Chiyoda-ku, Tokyo,
Japan
Phone: 81 (3) 6206-4721
Fax: 81 (3) 6206-4730

●HORIBA (China) Trading Co., Ltd.

Shanghai Office
Room 1701, United Plaza,
1468 Nanjing Rd. West,
Shanghai, 200040, China
Phone: 86 (21) 6289-6060
Fax: 86 (21) 6289-5553

Beijing Office
Room 1801, SK Tower,
Tower 1 No.6Jia, Jianguomenwai Ave.,
Chaoyang District, Beijing,
100022 China
Phone: 86 (10) 8567-9966
Fax: 86 (10) 8567-9066

●HORIBA Korea Ltd.

112-6 Sogong-Dong
Choong-ku, Seoul, Korea
Phone: 82 (2) 753-7911
Fax: 82 (2) 756-4972

●HORIBA Instruments (Singapore) Pte Ltd.

Head Office
10 Ubi Crescent
Lobby B #05-12, Ubi
Techpark Singapore 408564
Phone: 65 6745-8300
Fax: 65 6745-8155

Hanoi Office
Unit 10, 4 Floor, CMC tower,
Dich Vong Hau Ward, Cau Giay
district, Hanoi, Vietnam
Phone: 84 (4) 3795-8552
Fax: 84 (4) 3795-8553

Jakarta Office
Jl. Jend. Gatot, Subroto,
Kav 71-73, Menara Bidakara 2,
Unit 11-04, Jakarta Selatan,
12870, Indonesia
Phone: 62 (21) 2906-9419
Fax: 62 (21) 2906-9421

●HORIBA India Private Limited

Delhi Office
246, Okhla Industrial Estate,
Phase 3 New Delhi - 110020,
India
Phone: 91 (11) 4646-5000
Fax: 91 (11) 4646-5020

Pune Office
502, Purushottam Plaza,
Baner Road, Baner,
Pune - 411045 India
Phone: 91 (20) 2729-1121
Fax: 91 (20) 2719-1121

●HORIBA Instruments Irvine South Office

34 Bunsen Drive
Irvine, CA 92618, U.S.A.
Phone: 1 (949) 453-0500
Fax: 1 (949) 453-0600

●HORIBA (Austria) GmbH

Kaplanstrasse 5
A-3430 Tulln,
Austria
Phone: 43 (2272) 65225
Fax: 43 (2272) 65230

HORIBA Czech
Organizacni slozka Praha
Petrohradská 13
CZ-101 00 Praha 10,
Czech Republic
Phone: 420 (2) 717-464-80
Fax: 420 (2) 717-470-64

●HORIBA Europe GmbH

Head Office
Hans-Mess-Str.6
D-61440 Oberursel
Germany
Phone: 49 (6172) 1396-0
Fax: 49 (6172) 1373-85

Leichlingen Office
Julius-kronenberg Str.9
D-42799 Leichlingen
Germany
Phone: 49 (2175) 8978-0
Fax: 49 (2175) 8978-50

●HORIBA France Sarl

12, Avenue des Tropiques
F-91955 LES ULIS
France
Phone: 33 (1) 69-29-96-23
Fax: 33 (1) 69-29-95-77

●HORIBA UK Limited

Kyoto Close,
Summerhouse Road
Moulton Park, Northampton,
NN36FL, United Kingdom
Phone: 44 (1604) 542-600
Fax: 44 (1604) 542-696