

Test Tube pH Pen
850062, 850063, 850065,
850066, 850067

SPER
SCIENTIFIC

Environmental Measurement Instruments

CONTENTS

INTRODUCTION	2
FEATURES.	3
MATERIALS SUPPLIED	3
FRONT PANEL DESCRIPTION	4
LCD DISPLAY.	4
STANDARD CALIBRATION	5
CUSTOM CALIBRATION.	6
MEASUREMENT PROCEDURES	8
TROUBLESHOOTING.	13
ERROR CODES.	14
BATTERY INSTALLATION & REPLACEMENT	14
CARE AND MAINTENANCE.	17
SPECIFICATIONS	18
WARRANTY.	19

INTRODUCTION

These Sper Scientific Test Tube pH Pens (Models 850062/ 63 / 65 / 66 / 67) are designed for easy calibration and simple, accurate measurement.

The 12 cm long probe is capable of testing samples even in narrow-mouthed containers.

The waterproof meter provides one-button, automatic three-point calibration. Calibration is also possible within ± 0.5 pH units of 4, 7, and 10. Other features include a data-hold function, automatic shutoff and low-battery indicator.

Models 850063 / 65 / 66 / 67 also measure temperature and provide automatic temperature compensation.

FEATURES

- Waterproof IP65 housing
- Hold function
- One-button, automatic three-point calibration
- Automatic buffer recognition for calibration accuracy
- Customizable calibration values within ± 0.5 units of 4, 7, and 10
- Measuring stability indicator
- Protective storage bottle with KCl storage solution for sensor
- Low-battery indicator
- Automatic shutoff
- Dual pH and temperature display
(*Models 850063 / 65 / 66 / 67*)
- Monitors temperature in °F or °C
(*Models 850063 / 65 / 66 / 67*)

MATERIALS SUPPLIED

- Meter with protective storage bottle for sensor
- Two CR2032 button batteries
- Instruction Manual

FRONT PANEL DESCRIPTION

1. LCD
2. HOLD
3. CAL (calibration)
4. Power

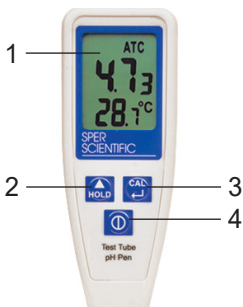

LCD DISPLAY

850062

1. pH reading
2. Data-hold indicator
3. Calibration
4. Low-battery icon

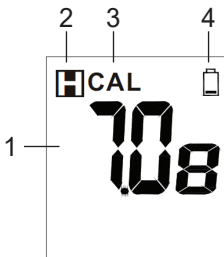

850063 / 65 / 66 / 67

1. pH reading
2. Data-hold indicator
3. Calibration
4. Automatic Temperature Compensation (ATC)
5. Low-battery icon
6. Temperature reading
7. Temperature units

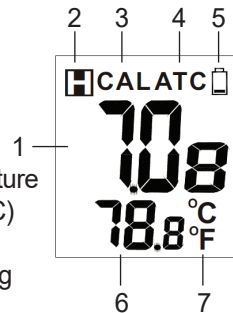

STANDARD CALIBRATION

The meter should be calibrated regularly with standard USA, NIST or DIN buffers to ensure accuracy. If the meter is used frequently, daily calibration is recommended.

Voltage Range for Each Calibration Point	
pH 4.00	97 mV to 250 mV
pH 7.00	-60 mV to 60 mV
pH 10.00	-250 mV to -97 mV

Calibration Procedure

1. Press **POWER** button to turn the meter **on**.
2. Pour the pH buffer into a clean container and place the electrode into the buffer. We recommend starting with a middle range buffer such as pH 7. Make sure the electrode is completely immersed in the buffer.
3. Press **CAL** to enter Calibration Mode.
"CAL" displays for one second, followed by the pH value. Models 850063 / 65 / 66 / 67 also display the temperature.

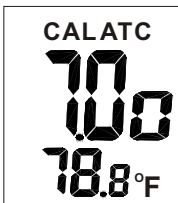

4. The meter will automatically recognize the buffer value, which will show on the screen.
5. Wait up to 10 seconds and "SA" will show on the screen indicating the calibration at that point is complete.
6. The meter will briefly display End and return to normal mode.
7. Repeat steps 2-5 for the pH 4 and 10 buffers.

CUSTOM CALIBRATION

During calibration mode, you can adjust the buffer values to non-standard values. For example,

4.00 pH may be adjusted from
3.50 to 4.50.

7.00 pH may be adjusted from
6.50 to 7.50.

10.00 pH may be adjusted from
9.50 to 10.50.

1. Place the electrode in the non-standard buffer and press the CAL button. The meter will display 4, 7, or 10 depending on which is closest.
2. Press and hold the Hold button. The number on the screen will begin to change in a positive direction.

3. Continue to press the hold button until your desired pH solution is displayed. Note that you may have to go beyond +0.5 units to get to a lower value.
4. Once you have selected the desired buffer value, release the hold button and wait up to 10 seconds. "SA" will display on the screen.
5. "End" displays and the meter returns to Normal Mode.

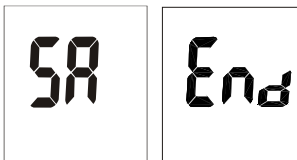

6. Rinse the probe with deionized water, a rinse solution, or tap water.
7. Repeat steps 2-7 to calibrate the meter with remaining buffer solutions.

Note...

If there is an error due to a damaged or incorrectly inserted probe, or if the buffer voltage is out of range, the meter will automatically exit calibration mode in 10 seconds. "End" displays for one second and the meter returns to Normal Mode.

MEASUREMENT PROCEDURES

Note...

The electrode should be soaked for at least 10 - 30 minutes in KCL solution before first use, or any time it has dried out. Avoid allowing the probe to dry out. It is normal for white crystals to be present on the cap or electrode assembly.

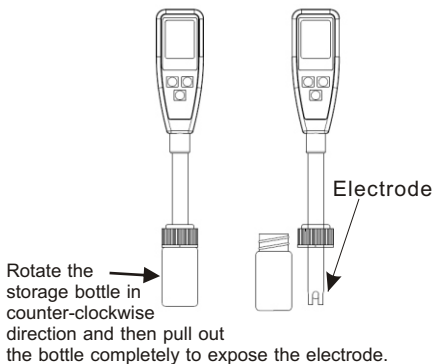

1. Unscrew the storage bottle and remove it from the probe, exposing the electrode.
2. Place the electrode into the test solution.
3. Press **POWER** button to turn the meter **on**.
4. Stir the probe gently to create a homogeneous sample and shorten the stabilizing time.

5. The pH decimal point will flash to indicate that the meter is in Measurement Mode.
6. The pH value displays on the LCD. Models 850063 / 65 / 66 / 67 also display the temperature.

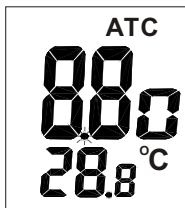

7. Press **POWER** button to turn the meter **off**.
8. Rinse the electrode with deionized water, a rinse solution, or tap water.
9. Store the probe in KCl solution when not in use.

Data Hold Function

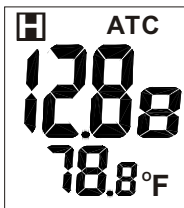

1. During measurement, press **HOLD** to freeze the reading on the display. "H" appears at the top of the LCD and the pH decimal point stops flashing.
2. Press **HOLD** to return to Normal Mode.

Automatic Shutoff

The meter automatically turns off after 20 minutes of inactivity. To disable this function:

1. If the meter is on, press **POWER** button to turn the meter **off**.
2. Press both **POWER** button and **HOLD** for two seconds.
3. The meter will turn on and “n” will display.

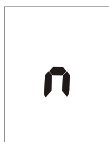

4. The meter returns to Normal Mode.
Automatic shutoff is now disabled.

Note...

The meter will default to automatic shutoff each time it is turned off.

Automatic Temperature Compensation (Models 850063 / 65 / 66 / 67)

“ATC” displays at the top of the LCD. The temperature is displayed in either °C or °F.

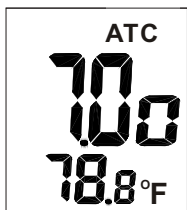

To select the temperature unit:

1. If the meter is on, press **POWER** to turn the meter **off**.
2. Press and hold both **POWER** and **CAL** until the temperature unit appears on the LCD.
3. Press **HOLD** to toggle between °C and °F.
4. Press **CAL** to save the selection.
5. “SA” displays for one second and the meter returns to Normal Mode.

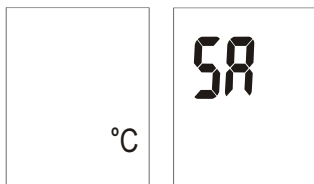

TROUBLESHOOTING

Problem	Action
The meter will not turn on / the LCD display is blank.	Press POWER button for more than 0.1 seconds.
	Check whether the batteries are correctly inserted.
	Remove the batteries for one minute and then reinstall them.
	Replace the old batteries with new ones.
Response time is slow	Clean the probe by immersing the electrode in tap water for 10-15 minutes. Rinse thoroughly with distilled water or use a general-purpose electrode cleaner.
Rapidly fluctuating pH value	This is normal when the electrode is exposed to air. The value will stabilize when the electrode is immersed in a solution.

ERROR CODES

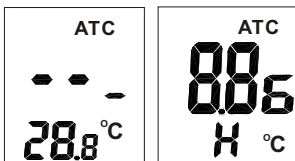

Error Code	Description
The pH reading displays “- - -”	The pH value is out of range: the solution is too acidic or too alkaline
The temperature reading displays “H” or “L” (Model 850063)	The temperature value is out of range: the temperature is too high or too low

BATTERY INSTALLATION AND REPLACEMENT

Note...

Remove the batteries when the meter will not be used for one month or longer.

This meter uses two CR2032 button batteries, which should provide over 100 hours of continuous use. When the low battery indicator appears on the LCD, battery replacement is needed.

1. If the meter is on, press **POWER** button to turn the meter **off**.
2. Remove the battery cover on the back of the meter by using the slot to turn it clockwise. The cover will now come off easily when you turn the timer over. (Take care not to discard the washer in the battery compartment.)
3. Remove the old batteries and replace with 2 new CR2032 button cell batteries, ensuring correct polarity.

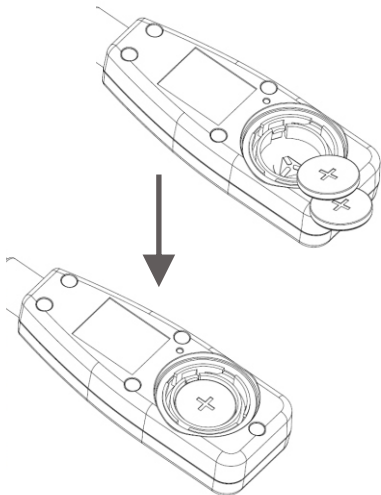

4. Replace the battery cover, positioning the tabs so that the cover is flush with the meter.
5. Secure the cover by turning it counter-clockwise.

Note...

Recalibrate the meter after replacing the batteries.

CARE AND MAINTENANCE

The electrode should be soaked for at least 30 minutes before first use, or any time it has dried out. It is normal for white crystals to be present on the cap or electrode assembly. Always handle and store the electrode with care.

- Do NOT touch, wipe or rub the tip of the electrode.
- The pH tip must always be kept moist. Place it in the protective storage bottle containing KCl storage solution whenever it is not in use.
- Rinse the electrode in deionized water, a rinse solution, or tap water before each use.
- Rinse the electrode in deionized water between measurements.

If the electrode has been exposed to a solvent immiscible with water:

- Clean it with a solvent miscible with water, such as ethanol or acetone.
- Rinse the electrode carefully with water.

SPECIFICATIONS

	ATC	Range	Res	Accuracy
850062	N/A	0 - 14.00	0.01	±0.2
850063	0 - 50°C / 32 - 122°F			±0.1
850065/66/67	0 - 50°C / 32 - 122°F	2 - 12.00	0.01	±0.1
Temperature	0 - 50°C / 32 - 122°F		0.1°C / °F	±1°C / 2°F
Operating Temperature	0 - 50°C / 32 - 122°F			
Operating RH%	< 80%			
Storage Temperature	-10 - 50°C / 14 - 122°F			
Storage RH%	< 90%			
LCD Display	29 x 22.5 mm			
Dimensions	235 x 35 x 25 mm (9¼" x 1¼" x 1") Pen - 115 x 35 x 25 mm (4½" x 1¼" x 1") Probe - 120 x 12 mm (4¾" x ½")			
Weight	71 g (2.5 oz)			

WARRANTY

Sper Scientific warrants this product against defects in materials and workmanship for **one (1) year** from the date of purchase, and agrees to repair or replace any defective unit without charge. If your model has since been discontinued, an equivalent Sper Scientific product will be substituted if available. This warranty does not cover damage resulting from accident, misuse, or abuse of the product. To obtain warranty service, ship the unit postage prepaid to:

SPER SCIENTIFIC LTD.

8281 E. Evans Rd., Suite #103
Scottsdale, AZ 85260
(480) 948-4448

Be sure to include a description of the problem and your return address. Register your product online at www.sperwarranty.com within 10 days.



