

6.0 DIMENSION DRAWINGS

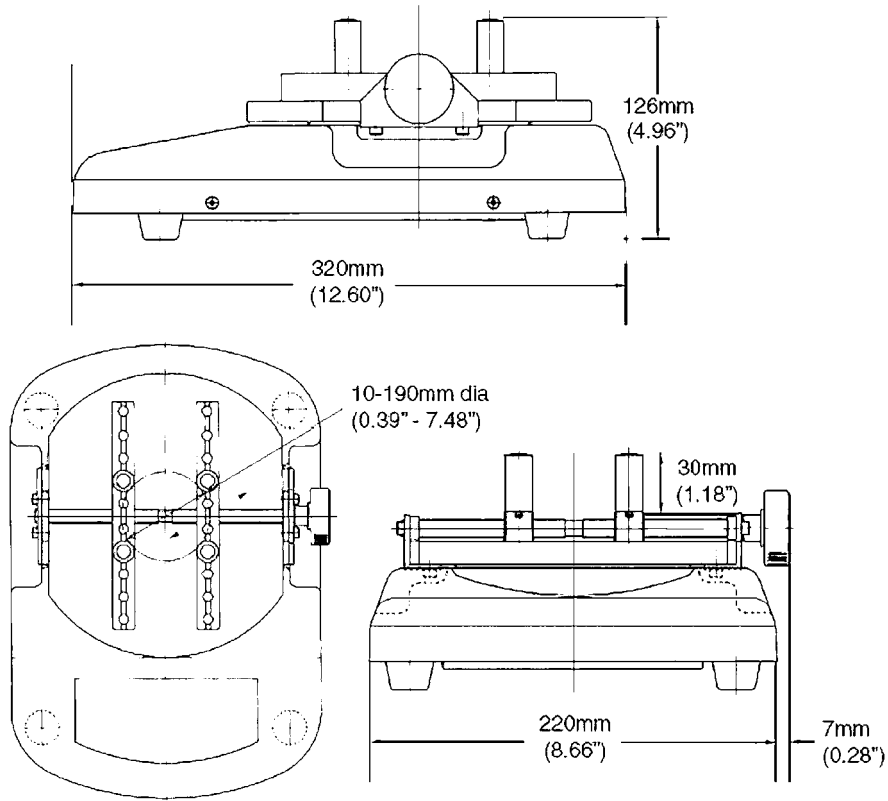

CONTENTS

1.0 Introduction	2
1.1 Complete Kit	
2.0 Overview	3
2.1 Key Function	
2.2 Main Display	
3.0 Accessing Secondary Functions	5
3.1 Function Table	
3.2 Changing the value of the selected function	
3.3 Moving through the Function Modes	
4.0 Operation	8
4.1 Preparing for testing	
4.2 Changing the Units of Measure	
4.3 Selecting the Measuring Mode	
4.4 Comparator functions	
4.5 Setting the HI and LOW values	
4.6 Zero Function	
4.7 Saving data in memory	
4.8 Recalling stored memory	
4.9 Clearing stored data	
5.0 Specifications	15
6.0 Dimensional Drawings	16
7.0 Warranty	17

1.0 INTRODUCTION

Thank you for choosing the CAP-TNP digital torque tester, with proper care this unit will provide many years of reliable service.

The CAP-TNP torque meter is a portable device that can be used as a quality assurance tool for various applications that requires turning (both opening and closing) and twisting.

Some fields that can utilize this equipment are:

- Pharmaceutical,
- Food and Beverage
- Cosmetic products

Built with internal rechargeable batteries, the CAP-TNP can operate as a portable DC device or thru the universal AC adapter. Designed with a small footprint it can easily be moved around the shop floor or the laboratory to maximize use.

The programmable HI-LO set points make this unit ideal for pass-fail testing in a production environment.

1.1 Complete Kit

Each package includes the following:

- Operations Manual
- Software Manual
- Software Installation Disk (Digitorq Software)
- Warranty Cards
- USB A to USB B communication cable
- Universal AC adapter (100-240 VAC)
- Set of 30 mm chuck pins (4 pieces)



IMPORTANT: Upon receiving the unit, please check for any obvious physical damage that may have occurred during shipping. If any damage is found, please notify your carrier immediately before shipping the unit back to Electromatic for repairs and inspections.



Do not test products that are filled with liquid contents. The CAP-TNP torque tester is not protected from liquid spills that may come from the tested product.

5.0 SPECIFICATIONS

OverloadProtection	150%
Sample Diameter Range	(min to max) 0.39" to 7.48" (10-190 mm)
Overload display	Display "OVR" on LCD (blinking on/off)
Main display	4-digit LCD display Character height 12mm
Sub display	3-digit LCD display Character height 7mm
Comparator display	Hi, GO, Lo LED Indicators
Accuracy	± 0.5% full scale
Open mode	Max vale when opening. Displays max counter clockwise torque.
Close mode	Max value when closing. Displays max clockwise torque
Average mode	Real time display. Displays max torque in real time
Display Update	1, 2, 4 or 8 updates/second, user-set
Sampling Rate	1000 times/second
Memory Storage	1000 data points (max)
Statistic process	Average value, max value and min value
Data output	USB 1.1
PC software	Digitorque software
Power	Built in nickle hydride battery or Auto-ranging AC adapter (AC 100 — 240V)
Dimensions	12.60" x 8.94" x 4.96" (320 x 227 x 126mm) L x W x H
Operation Temp.	32 - 104°F (0 - 40°C)
Battery Life	8 hours after full charge
Battery Recharge Time	Max. 16 hours
Battery Type	NiMH

Torque Ranges

Model	Capacity	Resolution
CAP-TNP-2	0-2.000 Nm	0.001 Nm
	0-200.0 Ncm	0.1 Ncm
	0-20.39 Kgcm	0.01 Kgcm
	0-17.70 Lbin	0.01 Lbin
CAP-TNP-5	0-5.000 Nm	0.001 Nm
	0-500.0 Ncm	0.1 Ncm
	0-50.99 Kgcm	0.01 Kgcm
	0-44.25 Lbin	0.01 Lbin
CAP-TNP-10	0-10.00 Nm	0.01 Nm
	0-1000 Ncm	1 Ncm
	0-102.0 Kgcm	0.1 Kgcm
	0-88.50 Lbin	0.1 Lbin

Example: The picture at right shows 3 data is saved (003) and the last value is 12.6. Pressing the **Zero/RST** key eliminates the last data (**CLR** will appear on the screen). Pressing the **Zero/RST** key again deletes the next data stored in the memory.



Shown on the below is a diagram illustrating how the single clear works.

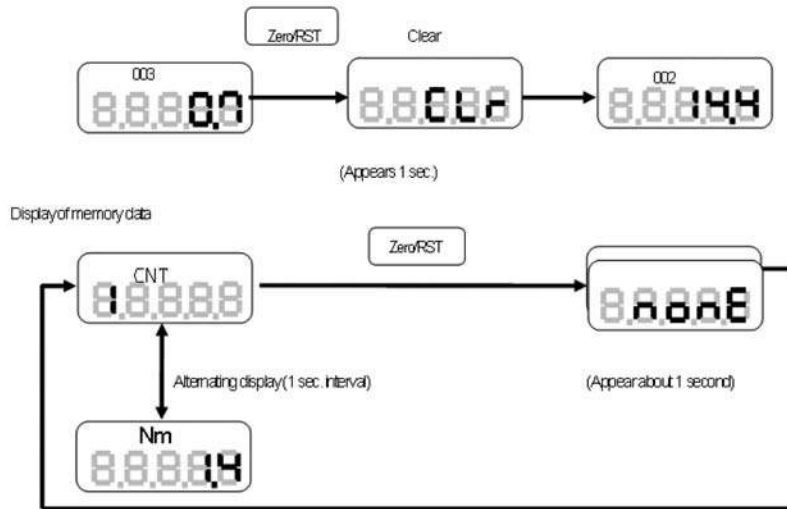

After all the data are erased, pressing the **Zero/RST** key returns the display to normal measuring condition.

Clear All Procedure

Clear all or erasing all stored data in memory is possible by doing the following.

1. Power off the TNP torque meter.
2. Press the **MEM** key and continue to hold this key while turning on the power. The CAP-TNP will initialize itself. You will see the model capacity displayed on the front panel then followed by the message **nonE**. This indicates that all data stored in memory are cleared.

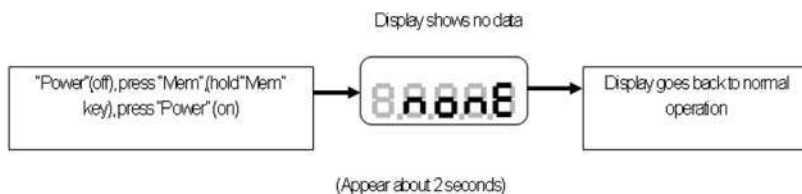

2.0 OVERVIEW

2.1 Key functions

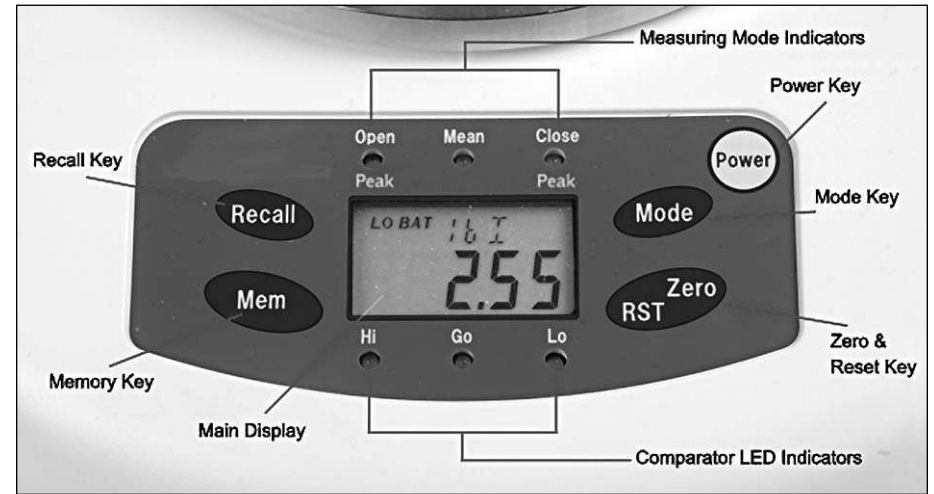

Power key	Turns the gauge ON and OFF.
Recall key	Recall data stored in OPEN and CLOSE modes. NOTE: in AVERAGE or MEAN mode the RECALL key has no function.
Mem key	Memory key for storing data in OPEN and 7 Modes. Note: In MEAN mode the Mem key has no function. In this mode data cannot be stored in memory. Mem combined with another key used in secondary functions. (Parameter and clear settings).
Mode key	Selects mode of operation (CLOSE, MEAN, and OPEN). Serves as an exit function when in Memory recall. Secondary function in parameter settings (see section 3.0, page 5)
Zero/RST key	Tare or zero function for resetting and initializing values while in Average or peak mode. Secondary function in parameter settings (see section 3.0, page 5)
Main Display	Displays measured values and status indicators, which includes units of measure, battery status, function status.
Measuring mode indicators	Red LED mode indicators. Informs which mode is selected OPEN, MEAN or CLOSE .
Comparator LED indicators	Quick pass/fail visual indicators for all modes of measurement. The LED indicator does not light when comparator feature is OFF.

2.2 Main Display

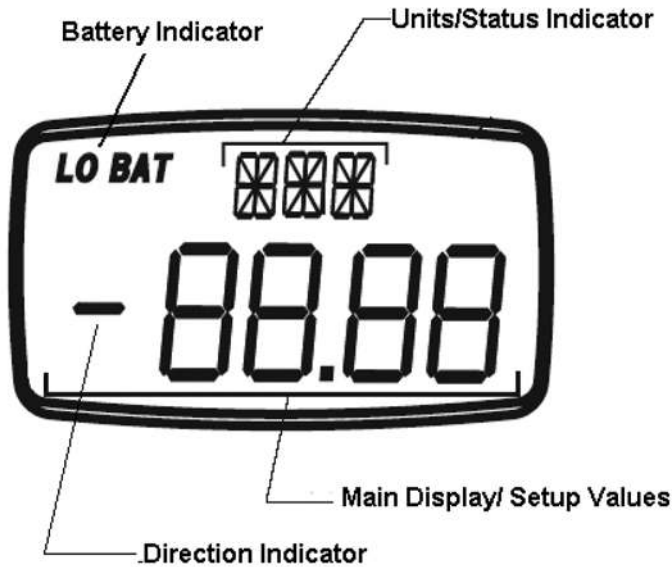

Units/Status indicator – located on the upper part of the display, this shows the current units of measure selected for the torque meter. It also serves a function sub-display under the function mode (F01, F02, F03, etc.)

- **OVR:** indicates an overload condition, meaning the CAP-TNP went over its rated capacity.
- **PWR:** when the auto power off feature is set from the torque meter this indicator serves as a 1 minute warning before the unit turns off.

Main display/Set up Values – shows the measured value in four digits including decimal places. Under the function mode it displays the options for each setting.

Direction Indicator – indicates direction of applied torque based upon the F04 setting (Please see sign orientation information from function mode table, section 3.1). By default a negative sign (-) indicates **closing**; no sign indicates opening.

Battery Indicator – shows the status of the internal battery of the CAP-TNP. **LO BAT** appears on the display to indicate a low battery status. **BAT** is shown when the TNP is charging. This indicator disappears when the battery is at full charge or the AC adapter is disconnected from the CAP-TNP.

NOTE: It is important that the battery be cycled properly to achieve the maximum battery life.

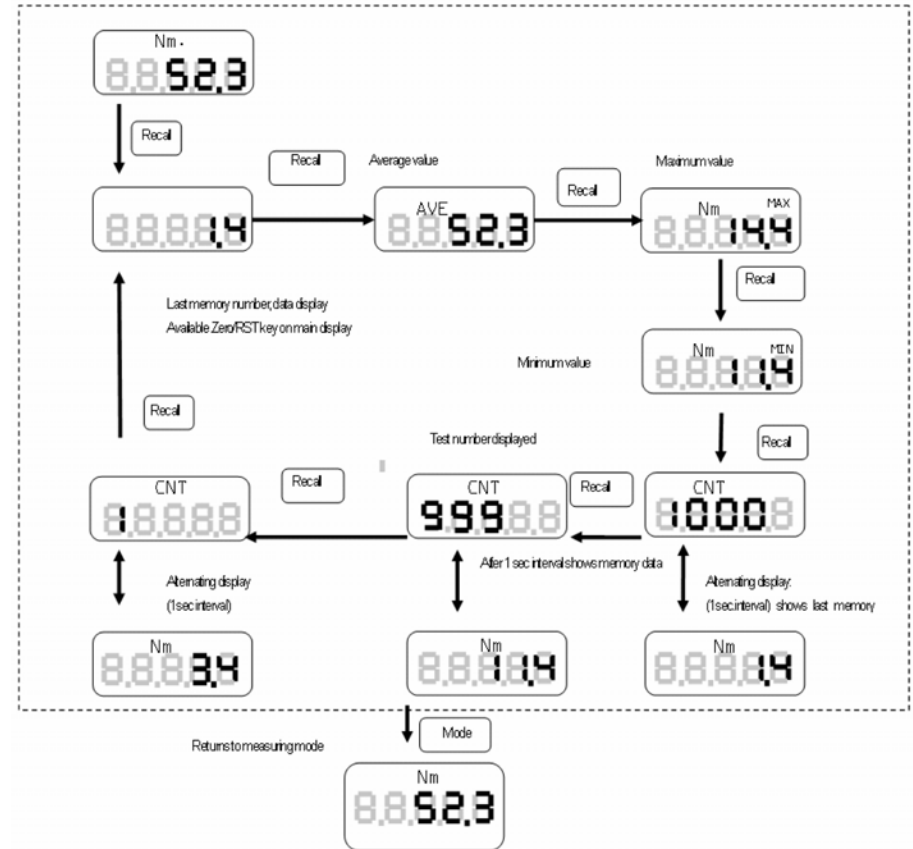

4.9 Clearing Stored Data

There are two types of clear available on the CAP-TNP torque meter.

- Single Clear
- Clear All

Single Clear Procedure

Single clear refers to erasing the stored data manually from the torque tester. The erase process starts from the most recent to the very earliest data stored.

NOTE: Clearing data that is within the set cannot be accomplished by single clear. The CAP-TNP does not allow the user to select the memory to be deleted.

1. Select from the OPEN or CLOSE modes (Mean or Average mode data cannot be stored).
2. Press the RECALL key to access memory, the first display that you will see will indicate the number of data stored in the torque tester and the last value saved.

3. Press Recall key second time to access the following information.

- Max
- Min
- Average
- Stored data (Order of data recall is based from the last data stored in memory)



Displays Max, Min and Average Values

To access the stored measured value use the RECALL key to scroll thru the values. (This will be after the MIN value is displayed). The display will flash two sets of numbers, the first number indicates the memory ID and the second number is the value stored on that memory ID.

NOTE: The order of values is from the last data stored to the first data stored. To review previous values shown, scroll thru the values using the RECALL key.



Picture above indicates the memory ID followed by the stored data. Pressing the mode button any time exits out of the memory window. Shown on the next page is a chart outlining how the Recall function works.

3.0 ACCESSING SECONDARY FUNCTIONS



This photo indicates the torque meter is in Function Mode.

Operation Key	Operation	How To Operate
Zero/RST Power	Function Mode	<ol style="list-style-type: none"> 1. With Power off, press and hold the Zero/RST key, then turn the power on. 2. Continue holding the Zero/RST key until the display shows F01. 3. Pressing the Mode key changes the value of the selected function mode. Pressing the Zero/RST key advances from one parameter to the next. The list of function are provided in the next section. (See picture above).
Function Mode	Clear Memory Date	<ol style="list-style-type: none"> 1. With Power off, press and hold the Mem key, then turn the power on. 2. Continue holding the Mem key until nonE appears on the display.

IMPORTANT: If the display indicates normal operation of the torque meter, but **F01** is not seen on the display, the Zero/RST key was released too soon. **Turn off the torque meter and repeat the process.**

3.1 Function Mode Table

FUNCTION	Sub display	Options	Initial Setting
Measuring Unit	F01	Changes units of measure: N.m, N.cm, Kg.cm, Lb.in	N.m
Function Mode	F02	Switch 1, 2, 4, 8 times/second	2
Display (update rate)	F03	10 minutes or so	10 minutes
Auto power OFF	F04	-0000 CCW (Open“-”); 0000 CW (Close“+”)	0000
Upper comparator value (Hi Limit)	HI	0000 – 9999; with decimal point. (Setting the values to zero disables this function)	0000
Lower comparator value (Lo Limit)	LO	0000 – 9999; with decimal point (Setting the values to zero disables this function).	0000

3.2 How to change the value on the function selected

To change the values of the function selected press the MODE key to scroll thru the options and the **Zero/RST** button to move to the next Mode.

NOTE: Pressing the MODE key after the HI/LO limits exits out of the function mode. You will need to reenter the settings to change additional values.

3.3 Moving through the Function Modes

1. Make sure the that gauge is turned off.
2. Press and hold the **Zero/RST** key.
3. Press and release the power key, but continue to hold the **Zero/RST** key.

NOTE: Use the **MODE** key to changes values of each function. Use the **Zero/RST** key to move to the next function.

4.6 Zero adjustment (Tare)

Taring or zeroing the value of the CAP-TNP initializes the torque meter to zero. This function is performed by simply pressing **Zero/RST** button from the front panel. In OPEN and CLOSE modes this zeros out the Peak values measured.

It is essential and recommended that the CAP-TNP be zeroed out before performing another test. This ensures that the gauge is properly initialized and no additional values are added to the measurement.

4.7 Saving Data in Memory

Data can be stored in the CAP-TNP by pressing the MEM key. This feature is only available in OPEN and CLOSE measuring modes. In AVERAGE mode the MEM key has no function.

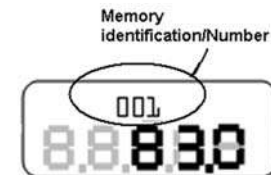
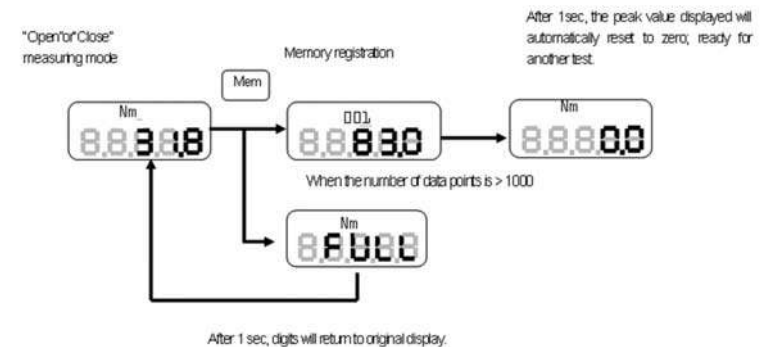

Take a closer look at the display. The upper sub-display indicates the memory identification number.

4.8 How to recall stored memory

1. Select OPEN or CLOSE Mode,
2. Press the RECALL key and the display will indicate the number of data stored in memory.



4. Press the **Zero/RST** key until the main display shows **HI** limit.
5. Use the **RECALL** key to set the highlighted digit from 0-9.
6. Press the **MEM** key to move from left to right or to the next digit.
7. If invalid values are entered, the display will blink momentarily indicating wrong values entered to the HI and LO limits. (HI>LO, HI=LO).
8. After entering the LO limit value and pressing the **Zero/RST** button the torque tester will go back to normal operation.



The chart below shows how the Comparator values are changed and accessed from the Function mode settings after F04.

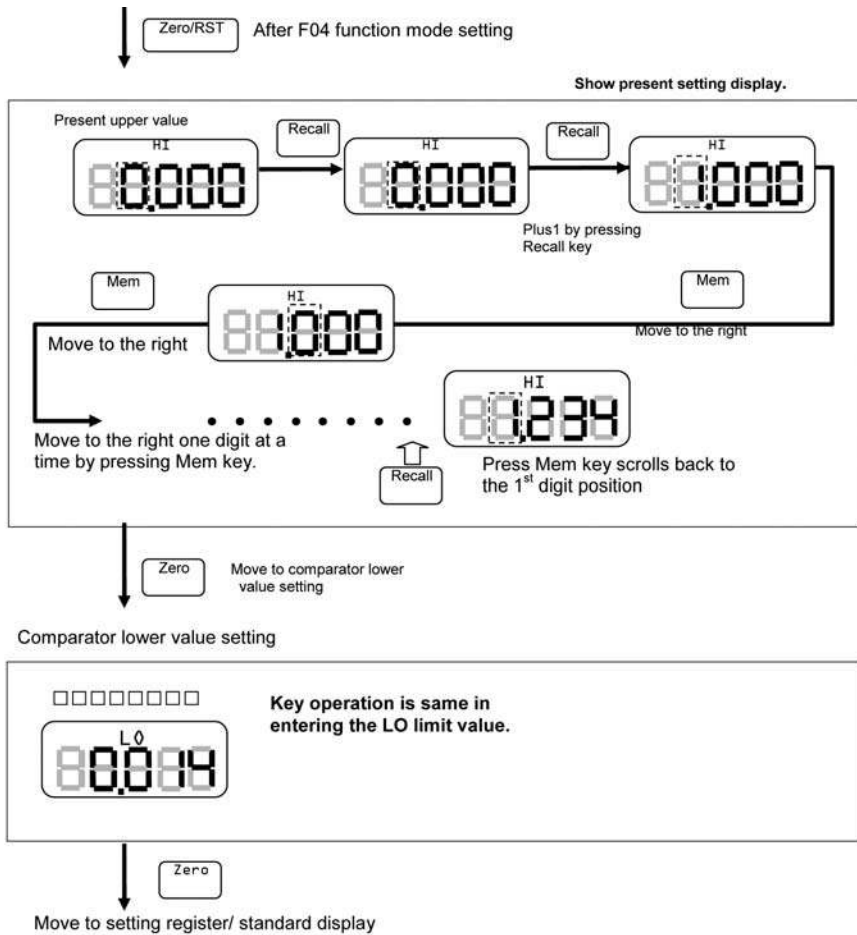

Turn OFF the TNP before starting



**Press and hold the Zero/RST key
Power on then release the Power button
but continue to hold Zero/RST key**



Function Mode – Unit values

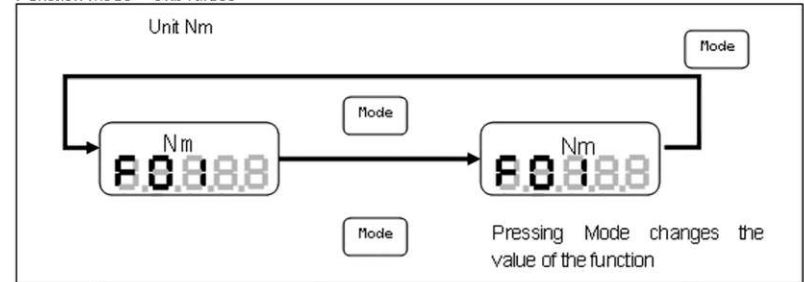

↓ Zero Pressing Zero mode to next function setting

Display Update

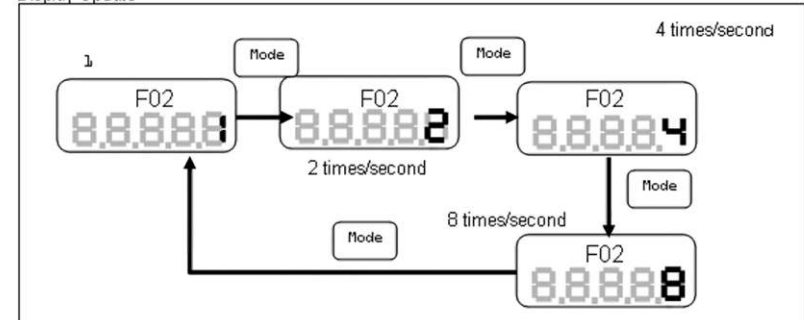

↓ Zero Move to auto power OFF setting

NOTE: Use the MODE key to changes values of each function. Use the Zero/RST key to move to the next function.

4.0 OPERATION

4.1 Preparing for testing

1. Determine the size of the sample to be tested. Adjust the 4-pin jig on the testing table accordingly.
2. Center the sample and use the knob to secure the sample in place (turn clockwise to tighten the jig to the sample material),

NOTE: It is important to make sure that all the jigs are flush against the moving brackets. Each jig has set pins which slide into place inside the grooved brackets.



4.2 Changing Units of Measure

1. Press and hold the **Zero/RST** key. The display will appear as shown at right.
2. While still pressing the **Zero/RST** key, press and release the **POWER** key. The display will change as shown at right.
3. Release the **Zero/RST** key. The display will change again as shown at right.
4. Press **MODE** to change the measuring unit. The sequence is as follows: **N-m** → **N-cm** → **Kg-Cm** → **Lb-in**
5. Press the **POWER** key to exit.

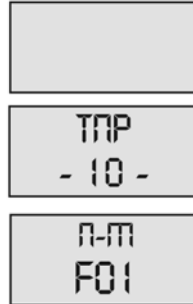

4.3 Selecting the Measuring Mode

1. Measuring modes available on the CAP-TNP are OPEN, CLOSE, and MEAN. Pressing the MODE Key toggles through the modes available. Red LEDs indicate the mode selected. See diagram below.

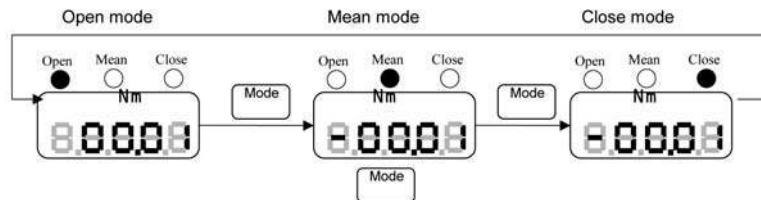

NOTE: OPEN and CLOSE modes are PEAK Values captured by the CAP-TNP, these values are not real-time values and are retained on the display until the **Zero/RST** key is pressed or a higher peak value is detected (which in this case replaces the current value detected). MEAN is the real-time value based on the average data captured at 1000 samples per second.

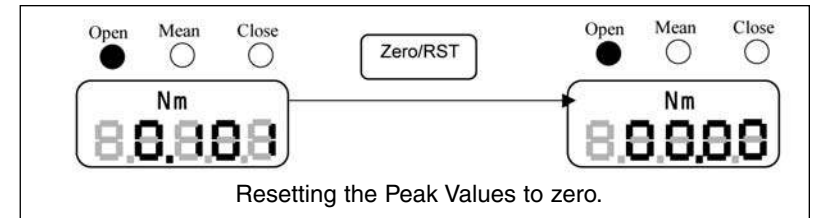

NOTE: The maximum display update for all modes is 8 times/second. This update rate can be adjusted by changing **F02** from function mode (section 3.2) Values available are 1, 2, 4, 8 times/second.

4.4 Comparator Function

This function compares the upper and lower limit based upon the values entered under function mode for HI and LO limits (section 4.4).

If both HI and LO limits are set to “0000” this feature is not available. The following conditions are valid under comparator mode:

- HI>LO
- HI=LO (HI Red LED indicator will be lit on the Comparator LED indicators).

This feature makes the CAP-TNP an ideal tool for quality assurance checking. Example: HI is set to 100 and LO is set to 50. Based from the conditions met the corresponding LED will light up — HI (Red LED), GO (Green LED), LO (Red LED).

From the previous example any values greater than 100 will light up the HI red LED.

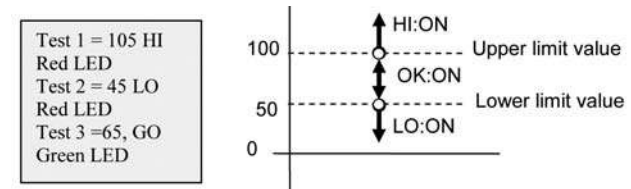

Any values lower than 50 will light up the LO red LED.

Values measured in between these values ($100 < X < 50$) will give a GO green LED indicator.

4.5 Setting the HI and LO values

To set the HI and LO limits from the TNP torque meter we need to access the function mode.

1. Turn off the torque meter.
2. Press and hold the **Zero/RST** key then turn on the power.
3. Continue to hold on the **Zero/RST** key until the main display shows **F01**.

7.0 WARRANTY

ELECTROMATIC Equip't Co., Inc. expressly warrants to its buyer for three (3) years from the date of delivery that the goods sold are free from defects in workmanship and materials. ELECTROMATIC Equip't Co., Inc. will, at its option, repair or replace or refund the purchase price of goods found to be defective. This remedy shall be the buyer's sole and exclusive remedy. Any modification, abuse, exposure to corrosive environment or use other than intended will void this warranty. This warranty is in lieu of all other warranties, including implied warranties of merchantability and fitness for an intended purpose. In no event shall ELECTROMATIC Equip't Co., Inc. be liable for any incidental and consequential damages in connection with goods sold or any part thereof.

CAP-TNP

DIGITAL CAP TORQUE TESTER



ELECTROMATIC
EQUIPMENT CO., INC.

600 Oakland Ave., Cedarhurst, NY 11516-U.S.A.
TEL: 516-295-4300 • FAX: 516-295-4399