

Instruction Manual

HI 96811, HI 96812 HI 96813, HI 96814 Refractometers for Wine and Grape Product Measurements

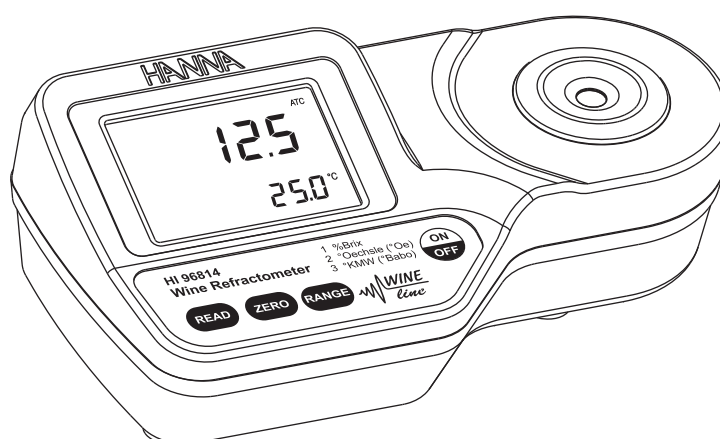

 **HANNA**[®]
instruments
www.hannainst.com

Supplied in Australia by Instrument Choice
Call our scientists on 1300 737 871
www.instrumentchoice.com.au

Dear Customer,

Thank you for choosing a Hanna product. This manual will provide you with the necessary information for the correct use of these instruments. Please read it carefully before using the meters. If you need additional technical information, do not hesitate to e-mail us at tech@hannainst.com. These instruments are in compliance with **CE** directives.

TABLE OF CONTENTS

PRELIMINARY EXAMINATION	2
GENERAL DESCRIPTION	3
SPECIFICATIONS	4
PRINCIPLE OF OPERATION	5
MEASUREMENT UNITS	6
FUNCTIONAL DESCRIPTION	7
DISPLAY ELEMENTS	8
MEASUREMENT GUIDELINES	9
CALIBRATION PROCEDURE	9
MEASUREMENT PROCEDURE	10
TO CHANGE MEASUREMENT UNIT (HI 96813, HI 96814)	11
TO CHANGE TEMPERATURE UNIT	12
TO CHANGE POTENTIAL ALCOHOL CONVERSION FACTOR (HI 96813 only)	13
MAKING A STANDARD %BRIX SOLUTION	13
ERROR MESSAGES	14
BATTERY REPLACEMENT	15
WARRANTY	15

PRELIMINARY EXAMINATION

Remove the instrument from the packing materials and examine carefully to ensure no damage has occurred during shipping. If any damage has occurred, notify your Dealer or closest Hanna Customer Service Center.

Each instrument is supplied with:

- 9 V battery
- Instruction manual

Note: Save all packing material until you are sure that the instrument functions correctly. A defective instrument must be returned in its original packing.

All rights are reserved. Reproduction in whole or in part is prohibited without the written consent of the copyright owner, Hanna Instruments Inc., Woonsocket, Rhode Island, 02895, USA.

GENERAL DESCRIPTION

The **HI 96811**, **HI 96812**, **HI 96813** and **HI 96814** Digital Wine Refractometers are rugged portable, water resistant devices that benefit from Hanna's years of experience as a manufacturer of analytical instruments. Hanna offers four related wine refractometers to fill the differing requirements found in the industry. All are equally valid ways to measure the sugar content of grape or must samples in the field or winery.

The **HI 96811**, **HI 96812**, **HI 96813** and **HI 96814** are optical instruments that are based on the measurement of the refractive index of a solution. The measurement of refractive index is simple and quick and provides the vintner a standard accepted method for sugar content analysis. Samples are measured after a simple user calibration with deionized or distilled water. Within seconds the instrument measures the refractive index of the grape. These digital refractometers eliminate the uncertainty associated with mechanical refractometers and are easily portable for measurements in the field.

The four instruments utilize internationally recognized references for unit conversion and temperature compensation.

HI 96811 measures %Brix

HI 96812 measures °Baumé

HI 96813 measures %Brix
Potential Alcohol (% vol)

HI 96814 measures %Brix
°Oechsle (°Oe)
°KMW (°Babo)

Temperature (in °C or °F) is displayed simultaneously with the measurement on the large dual level display along with icons for Low Power and other helpful message codes.

Key features include:

- Dual-level LCD
- Automatic Temperature Compensation (ATC)
- Easy setup and storage
- Battery operation with Low Power indicator (BEPS)
- Automatically turns off after 3 minutes of non-use
- Single-point calibration with distilled or deionized water
- Waterproof models offers IP65 waterproof protection
- Quick, precise results readings are displayed in approximately 1.5 seconds
- Small sample size as small as 2 metric drops.

SPECIFICATIONS

HI 96811

Range: 0 to 50 %Brix / 0 to 80°C (32 to 176°F)
Resolution: 0.1 %Brix / 0.1°C (0.1°F)
Accuracy: ±0.2 %Brix / ±0.3°C (±0.5°F)

HI 96812

Range: 0 to 28 °Baumé / 0 to 80°C (32 to 176°F)
Resolution: 0.1 °Baumé / 0.1°C (0.1°F)
Accuracy: ±0.1 °Baumé / ±0.3°C (±0.5°F)

HI 96813

Range: 0 to 50 %Brix / 0 to 25 % v/v Potential Alcohol / 0 to 80°C (32 to 176°F)
Resolution: 0.1 %Brix / 0.1 % v/v Potential Alcohol / 0.1°C (0.1°F)
Accuracy: ±0.2 %Brix / ±0.2 % v/v Potential Alcohol / ±0.3°C (±0.5°F)

HI 96814

Range: 0 to 50 %Brix / 0 to 230 °Oechsle / 0 to 42 °KMW / 0 to 80°C (32 to 176°F)
Resolution: 0.1 %Brix / 1 °Oechsle / 0.1 °KMW / 0.1°C (0.1°F)
Accuracy: ±0.2 %Brix / ±1 °Oechsle / ±0.2 °KMW / ±0.3°C (±0.5°F)

COMMON SPECIFICATIONS

Temperature Compensation:	Automatic between 10 and 40°C (50 - 104°F)
Measurement Time:	Approximately 1.5 seconds
Minimum Sample Volume:	100µL (cover prism totally)
Light Source:	Yellow LED
Sample Cell:	Stainless Steel ring and flint glass prism
Case Material:	ABS
Enclosure Rating:	IP 65
Battery Type / Life:	1 X 9V / 5000 readings
Auto-Off:	After 3 minutes of non-use
Dimensions:	19.2(W) x 10.2(D) x 6.7(H) cm
Mass:	420 g

PRINCIPLE OF OPERATION

%Brix, °Baumé, °Oechsle, °KMW and % potential alcohol determinations are made by measuring the refractive index of a solution. Refractive Index is an optical characteristic of a substance and the number of dissolved particles in it. Refractive Index is defined as the ratio of the speed of light in empty space to the speed of light in the substance. A result of this property is that light will “bend”, or change direction, when it travels through a substance of different refractive index. This is called refraction.

When passing from a material with a higher to lower refractive index, there is a critical angle at which an incoming beam of light can no longer refract, but will instead be reflected off the interface. The critical angle can be used to easily calculate the refractive index according to the equation:

$$\sin(\theta_{\text{critical}}) = n_2 / n_1$$

Where n_2 is the refractive index of the lower-density medium; n_1 is the refractive index of the higher-density medium.

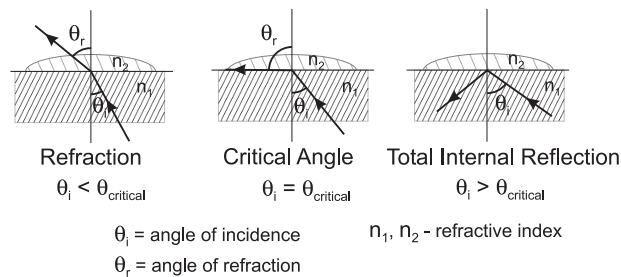

In the Hanna wine measurement refractometers, light from an LED passes through a prism in contact with the sample. An image sensor determines the critical angle at which the light is no longer refracted through the sample.

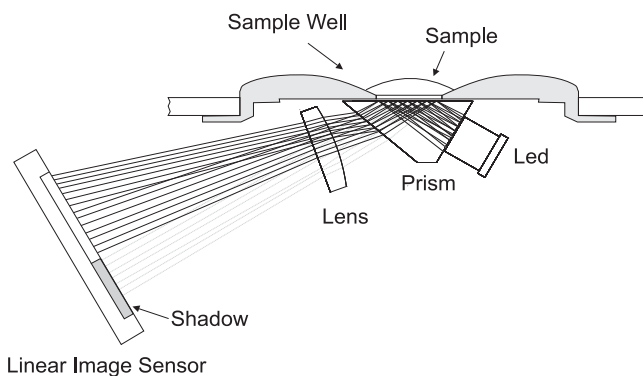

Specialized algorithms then apply temperature compensation to the measurement and convert this refractive index to the model specific measurement unit.

MEASUREMENT UNITS

HI 96811, HI 96812, HI 96813 and HI 96814 measure sugar content in several units to meet the differing requirements found in the wine industry.

HI 96811, HI 96813 and HI 96814 convert the refractive index of the sample to sucrose concentration in units of percent by weight, %Brix (also referred to as °Brix). The conversion used is based on the ICUMSA Methods Book (International Commission for Uniform Methods of Sugar Analysis). Since the majority of sugar in grape juice is fructose and glucose and not sucrose, the reading is sometimes referred to as "Apparent Brix".

HI 96812 has units of °Baumé. The °Baumé scale is based on density and was originally designed to measure the mass of sodium chloride in water. °Baumé is used in wine making to measure the sugar in must. The **HI 96812** converts the %Brix reading to °Baumé based on the table found in the Official Methods of Analysis of AOAC International, 18th Edition. 1 °Baumé is approximately equal to 1.8 %Brix, and 1 °Baumé is roughly equivalent to 1 % alcohol when the wine is fully fermented. In addition to %Brix, **HI 96814** includes two other scales used in the wine industry: °Oechsle and °KMW.

°Oechsle (°Oe) is mainly used in the German, Swiss and Luxemburgish winemaking industry to measure the sugar content of must. The °Oe scale is based on specific gravity at 20°C (SG20/20) and is the first 3 digits following the decimal point. 1 °Oe is roughly equal to 0.2 %Brix.

$$^{\circ}\text{Oe} = [(\text{SG}20/20) - 1] \times 1000$$

°Klosterneuburger Mostwaage (°KMW) is used in Austria to measure the sugar content of must. °KMW is related to °Oe by the following equation:

$$^{\circ}\text{Oe} = ^{\circ}\text{KMW} \times [(0.022 \times ^{\circ}\text{KMW}) + 4.54]$$

1 °KMW is roughly equivalent to 1 %Brix or 5 °Oe. °KMW is also known as °Babo.

In addition to %Brix, **HI 96813** also has a second scale that estimates the alcohol content in the finished wine in (% vol/vol). This is known as "potential" or "probable" alcohol since the conversion between sugar and alcohol depends on many factors such as the type of grapes, the grape maturity, the growing region and yeast fermentation efficiency and temperature.

Since no fixed conversion factor is universally applicable, **HI 96813** allows the user to tailor the instrument to their specific needs based on their experience.

The first conversion is based on the %Brix value, with an adjustable conversion factor anywhere between 0.50 and 0.70 (0.55 is a common value).

$$\text{Potential alcohol (\% v/v)} = (0.50 \text{ to } 0.70) \times \% \text{Brix}$$

One drawback of the above equation is that it does not take into account the nonfermentable sugars and extract.

A second equation was also added that takes these factors into account and can give a more accurate estimate of the alcohol content in the finished wine. This conversion is named "C1" on the meter, and uses the following equation:

$$\text{Potential Alcohol (\% v/v)} = 0.059 \times [(2.66 \times ^{\circ}\text{Oe}) - 30] \quad (\text{C1})$$

FUNCTIONAL DESCRIPTION

TOP VIEW

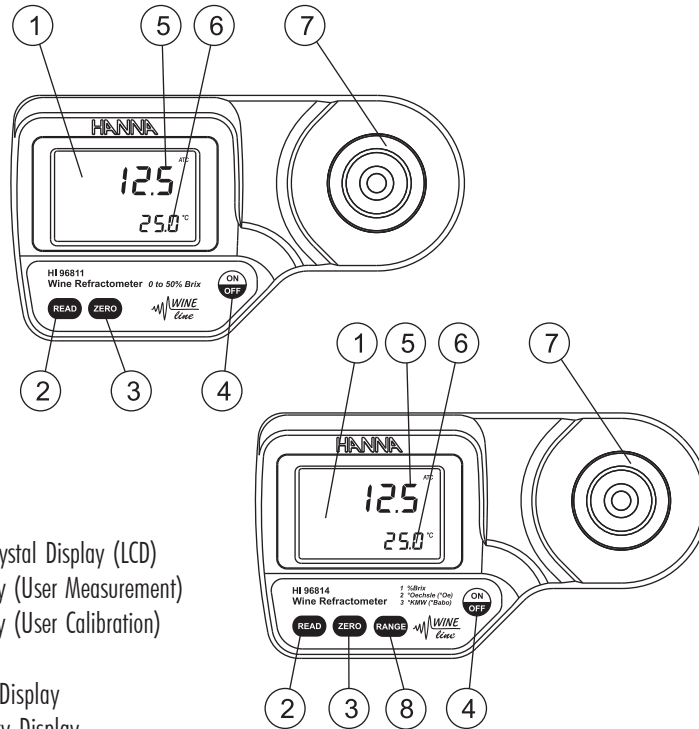

1. Liquid Crystal Display (LCD)
2. READ Key (User Measurement)
3. ZERO Key (User Calibration)
4. ON/OFF
5. Primary Display
6. Secondary Display
7. Stainless Steel Sample Well and Prism
8. RANGE (HI 96813 and HI 96814 only)

BOTTOM

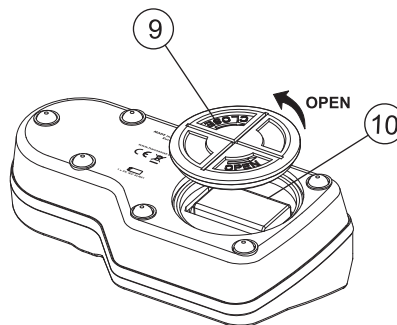

9. Battery Cover
10. Battery Compartment

DISPLAY ELEMENTS

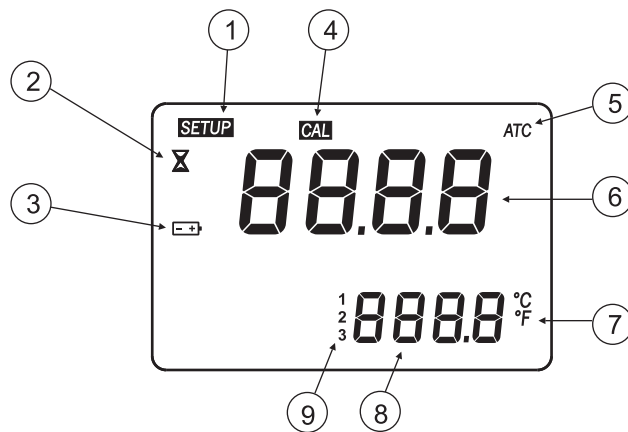

1. SETUP: Factory Calibration Tag
2. Measurement in Progress Tag
3. Battery (blinks when low battery condition detected)
4. CAL: Calibration Tag
5. Automatic Temperature Compensation
(blinks when temperature exceeds 10-40°C / 50-104°F range)
6. Primary Display (displays measurement and error messages)
7. Temperature Units
8. Secondary Display (displays temperature measurements; when blinking, temperature has exceeded operation range: 0-80°C / 32-176°F)
9. Range indicator (HI 96813 and HI 96814 only)

MEASUREMENT GUIDELINES

- Handle instrument carefully. Do not drop.
- Do not immerse instrument under water.
- Do not spray water to any part of instrument except the “sample well” located over the prism.
- The instrument is intended to measure grape/wine solutions. Do not expose instrument or prism to solvents that will damage it. This includes most organic solvents and extremely hot or cold solutions.
- Particulate matter in a sample may scratch the prism. Absorb sample on soft tissue and rinse sample well with deionized or distilled water between samples.
- Use plastic pipettes to transfer all solutions. Do not use metallic tools such as needles, spoons or tweezers as these will scratch the prism.
- Cover sample well with hand if measuring in direct sun.

CALIBRATION PROCEDURE

Calibration should be performed daily, before measurements are made, when the battery has been replaced, or between a long series of measurements.

1. Press the **ON/OFF** key, then release. Two instrument test screens will be displayed briefly; all LCD segments followed by the percentage of remaining battery life. When the LCD displays dashes, the instrument is ready.

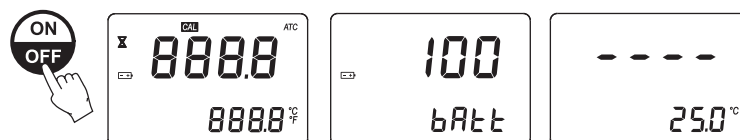

2. Using a plastic pipette, fill the sample well with distilled or deionized water. Make sure the prism is completely covered.

Note: If the ZERO sample is subject to intense light such as sunlight or another strong source, cover the sample well with your hand or other shade during the calibration.



3. Press the **ZERO** key. If no error messages appear, your unit is calibrated.

(For a description of **ERROR MESSAGES** see page 14).

Note: The 0.0 screen will remain until a sample is measured or the instrument is turned off.



4. Gently absorb the ZERO water standard with a soft tissue. Use care not to scratch the prism surface. Dry the surface completely. The instrument is ready for sample measurement.

Note: If instrument is turned off the calibration will not be lost.



MEASUREMENT PROCEDURE

Verify the instrument has been calibrated before taking measurements.

For **HI 96813** and **HI 96814** select the desired measurement unit (see page 11).

1. Wipe off prism surface located at the bottom of the sample well. Make sure the prism and sample well are completely dry.



2. Using a plastic pipette, drip sample onto the prism surface. Fill the well completely.



Note: If the temperature of the sample differs significantly from the temperature of the instrument, wait approximately 1 minute to allow thermal equilibration.

3. Press the **READ** key. The results are displayed in unit of interest.

Note: The last measurement value will be displayed until the next sample is measured or the instrument is turned off. Temperature will be continuously updated.

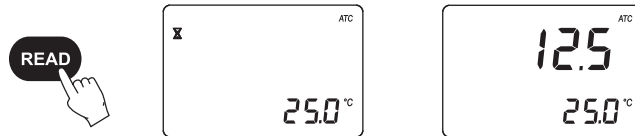

Note: The "ATC" tag blinks and automatic temperature compensation is disabled if the temperature exceeds the 10-40 °C / 50-104 °F range.

4. Remove sample from the sample well by absorbing on a soft tissue.
5. Using a plastic pipette, rinse prism and sample well with distilled or deionized water. Wipe dry. The instrument is ready for the next sample.

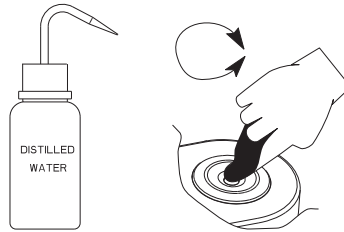

TO CHANGE MEASUREMENT UNIT (HI 96813, HI 96814)

For HI 96813 only:

1. Press the **RANGE** key to select measurement units of %Brix or % potential alcohol. The instrument toggles between the two measurement scales each time the key is pressed and the primary display indicates "bri" for %Brix or "P.ALC" for potential alcohol. When the instrument displays the screen with 4 dashes, the instrument is ready for measurement. A number on the display indicates the selected unit: "1" denotes %Brix and "2" denotes potential alcohol as indicated on the instrument cover.



2. The potential alcohol scale also indicates the conversion factor chosen for the potential alcohol reading. See TO CHANGE POTENTIAL ALCOHOL CONVERSION FACTOR (page 13) to change the current factor.

Note: When changing ranges the presently configured conversion factor will be displayed in the lower display. (See page 13)

For HI 96814 only:

1. Press the **RANGE** key to select measurement units %Brix, °Oechsle (°Oe) or °KMW (°Babo). The instrument toggles between the three scales each time the key is pressed and the primary display indicates "bri" for %Brix, "OE" for °Oechsle or "bAbo" for °KMW. When the instrument displays the screen with 4 dashes the instrument is ready for measurement. A number on the display indicates the selected unit: "1" denotes %Brix, "2" denotes °Oe and "3" denotes °KMW as indicated on the instrument cover.

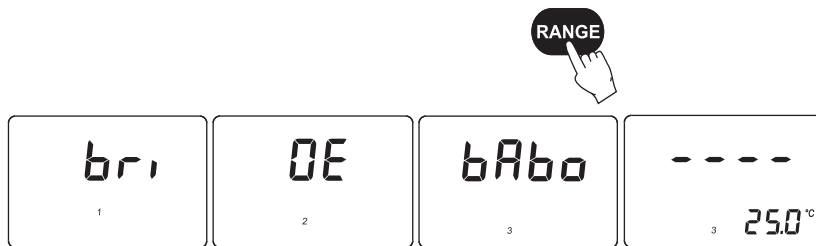

TO CHANGE TEMPERATURE UNIT

To change the temperature measurement unit from Celsius to Fahrenheit (or vice versa), follow this procedure.

1. Press and hold the **ON/OFF** key continuously for approximately 8 seconds. The LCD will display the "all segment" screen followed by a screen with the model number on the primary display and the version number on the secondary display. Continue pressing the **ON/OFF** key.

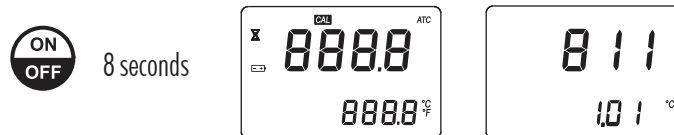

2. While continuing to hold the **ON/OFF** key, press the **ZERO** key. The temperature unit will change from °C to °F or vice versa.

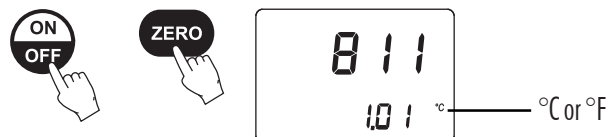

TO CHANGE POTENTIAL ALCOHOL CONVERSION FACTOR (HI 96813 only)

To change the potential alcohol conversion factor, follow this procedure.

1. Press and hold **ON/OFF** key continuously for approximately 8 seconds. The LCD will display all segments screen followed by a screen with the model number on the primary display and the version number on the secondary display. Continue pressing the **ON/OFF** key.



2. While continuing to hold **ON/OFF**, press the **RANGE** key. The LCD will show the current conversion factor on the primary display and "P.ALc" on the secondary display. Continue holding the **ON/OFF** key. Press the **ZERO** key to increase this number. The number will continually increase until "0.70" is reached then wrap back to "C1". The user selectable conversion range is 0.50 to 0.70. C1 stands for "curve 1" (see page 6). When you reach the conversion factor you desire release the **ON/OFF** key. The new conversion factor will be used.

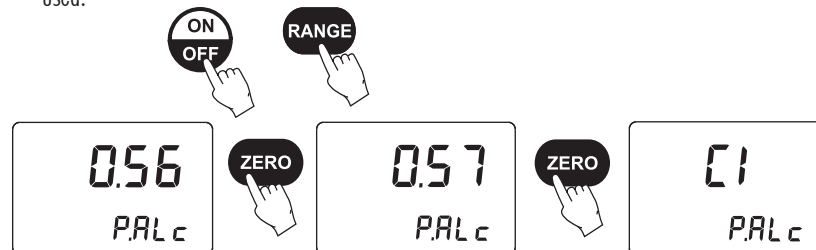

MAKING A STANDARD %BRIX SOLUTION









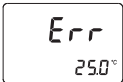

To make a Brix Solution, follow the procedure below:

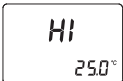
- Place container (such as a glass vial or dropper bottle that has a cover) on an analytical balance.
- Tare the balance.
- To make an X BRIX solution weigh out X grams of high purity Sucrose (CAS #: 57-50-1) directly into the container.
- Add distilled or deionized water to the container so the total weight of the solution is 100 g.
- **Note:** Solutions above 60 %Brix need to be vigorously stirred or shaken and heated in a water bath. Remove solution from bath when sucrose has dissolved. The total quantity can be scaled proportionally for smaller containers but accuracy may be sacrificed.

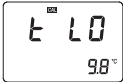
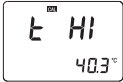
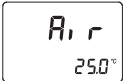
Example with 25 %Brix:

<u>%Brix</u>	<u>g Sucrose</u>	<u>g Water</u>	<u>g Total</u>
25	25.000	75.000	100.000

ERROR MESSAGES

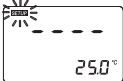
Error Code	LCD	Description
"Err"		General failure. Cycle power to instrument. If error persists, contact Hanna.
"LO" Primary display		Sample is reading lower than the 0 % standard used for meter calibration.
"HI" Primary display		Sample exceeds maximum measurement range.
"LO" Primary display "CAL" segment ON		Wrong solution used to zero instrument. Use deionized or distilled water. Press ZERO.
"HI" Primary display "CAL" segment ON		Wrong solution used to zero instrument. Use deionized or distilled water. Press ZERO.
"t LO" Primary display "CAL" segment ON		Temperature exceeds ATC low limit (10 °C) during calibration.
"t HI" Primary display "CAL" segment ON		Temperature exceeds ATC high limit (40 °C) during calibration.
"Air"		Prism surface insufficiently covered.
"ELt"		Too much external light for measurement. Cover sample well with hand.
"nLt"		LED light is not detected. Contact Hanna.
Battery segment blinking		<5 % of battery life is remaining.
Temperature values are blinking "0.0°C" or "80.0°C"		Temperature measurement out of sampling range (0.0 to 80.0°C).
"ATC" segment blinking		Outside temperature compensation range (10 to 40°C).
"SETUP" segment blinking		Factory calibration lost. Contact Hanna.

BATTERY REPLACEMENT

To replace the instrument's battery, follow these steps:

- Make sure the instrument is off.



- Turn instrument upside down and remove the battery cover by turning it counterclockwise.

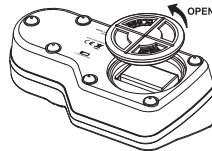

- Extract the battery from its location.
- Replace with a new 9V battery making sure to observe polarity.
- Insert the back battery cover and fasten it by turning clockwise to engage.

WARRANTY

HI 96811, HI 96812, HI 96813 and HI 96814 are warranted for two years against defects in workmanship and materials when used for its intended purpose and maintained according to the instructions.

This warranty is limited to repair or replacement free of charge.

Damage due to accident, misuse, tampering or lack of prescribed maintenance is not covered. If service is required, contact your dealer. If under warranty, report the model number, date of purchase, serial number and the nature of the failure. If the repair is not covered by the warranty, you will be notified of the charges incurred.

If the instrument is to be returned to Hanna Instruments, first obtain a Returned Goods Authorization Number from the Customer Service Department and then send it with shipment costs prepaid. When shipping any instrument, make sure it is properly packaged for complete protection.

To validate your warranty, fill out and return the enclosed warranty card within 14 days from the date of purchase.

SALES AND TECHNICAL SERVICE CONTACTS

Australia:

Tel. (03) 9769.0666 • Fax (03) 9769.0699

China:

Tel. (10) 88570068 • Fax (10) 88570060

Egypt:

Tel. & Fax (02) 2758.683

Germany:

Tel. (07851) 9129-0 • Fax (07851) 9129-99

Greece:

Tel. (210) 823.5192 • Fax (210) 884.0210

Indonesia:

Tel. (210) 4584.2941 • Fax (210) 4584.2942

Japan:

Tel. (03) 3258.9565 • Fax (03) 3258.9567

Korea:

Tel. (02) 2278.5147 • Fax (02) 2264.1729

Malaysia:

Tel. (603) 5638.9940 • Fax (603) 5638.9829

Singapore:

Tel. 6296.7118 • Fax 6291.6906

South Africa:

Tel. (011) 615.6076 • Fax (011) 615.8582

Taiwan:

Tel. 886.2.2739.3014 • Fax 886.2.2739.2983

Thailand:

Tel. 66.2619.0708 • Fax 66.2619.0061

United Kingdom:

Tel. (01525) 850.855 • Fax (01525) 853.668

USA:

Tel. (401) 765.7500 • Fax (401) 765.7575

MAN96811
03/09

*For e-mail contacts and a complete list of Sales and Technical offices, please see
www.hannainst.com.*

Supplied in Australia by Instrument Choice
Call our scientists on 1300 737 871
www.instrumentchoice.com.au