

## Measuring Instruments for Humidity



%RH

°C

°C td

hPa

rpm

aW

CO<sub>2</sub>

CO

mA

V

Requirements

Gas or air humidity measurements are becoming more and more important. Constant improvements to the technical processes, higher demands on quality and energy saving require an accurate, stable and affordable measuring procedure to measure air humidity.

Different measuring methods

Hair hygrometer	Psychrometer	Dew point mirror	Capacitive humidity sensor
<p>The hair hygrometer is one of the oldest methods used to measure humidity. The length of the hairs changes in accordance with the ambient humidity. This change is mechanically indicated as relative humidity.</p>	<p>A temperature probe covered usually with a damp cotton sleeve cools down as a result of evaporation. A second temperature probe measures the ambient temperature. The ambient humidity can be determined from the difference in temperature.</p>	<p>A mirror is cooled until it shows condensation after having reached the dew point temperature. The condensation on the mirror is monitored and the dew point is then measured.</p>	<p>A condensator changes its capacity in accordance with the ambient humidity.</p>
<p><b>Advantages</b></p> <ul style="list-style-type: none"> <li>- Simple to use measuring engineering with low installation costs</li> <li>- Low cost applications</li> </ul>	<p><b>Advantages</b></p> <ul style="list-style-type: none"> <li>- If used with care a very accurate measurement of 2 to 3 %RH is possible</li> </ul>	<p><b>Advantages</b></p> <ul style="list-style-type: none"> <li>- Wide measuring range</li> <li>- Highly accurate</li> </ul>	<p><b>Advantages</b></p> <ul style="list-style-type: none"> <li>- Affordable, quick-action and accurate measurement (up to ±1%RH)</li> <li>- Wide measuring range (0 to 100 %RH, -40 to +180°C)</li> <li>- Long-term stability</li> <li>- Small, portable measuring instruments</li> </ul>
<p><b>Disadvantages</b></p> <ul style="list-style-type: none"> <li>- High maintenance costs</li> <li>- Frequent regeneration of the hairs</li> <li>- Can be used only from 15 % to 85 %RH and up to max. 50 °C</li> <li>- Highly inaccurate, not definable</li> <li>- Slow measurements</li> </ul>	<p><b>Disadvantages</b></p> <ul style="list-style-type: none"> <li>- Cannot be used for multipoint measurements</li> <li>- Time-consuming handling (must be moistened with distilled water before nearly every measurement)</li> <li>- Before every important measurement, the temperature must be adapted to the ambient temperature and the sleeve should be changed</li> </ul>	<p><b>Disadvantages</b></p> <ul style="list-style-type: none"> <li>- Time-consuming, expensive method</li> <li>- Not battery-operated</li> <li>- Heavy (non-portable measuring instrument)</li> <li>- Highly accurate temperature measurement required</li> <li>- Slow adaptation time</li> <li>- Large bench-top instruments</li> </ul>	<p><b>In the past...</b> capacitive sensors were regarded as unreliable and unstable.</p> <p><b>Today...</b> Testo's capacitive sensor has been tested worldwide and has established itself in industrial measurement engineering.</p>

Testo humidity sensor

Testo has succeeded in increasing the range of applications for capacitive sensors with the humidity sensor developed here:

- Application temperatures to +180 °C
- Dew point measurement from -50 to +100 °C
- Long-term measurement under extreme conditions
- Highly accurate in the high humidity range (>95%RH)

The outstanding characteristics of the Testo humidity sensor are as follows:

- Precision
- Long-term stability
- Temperature resistance
- Robustness

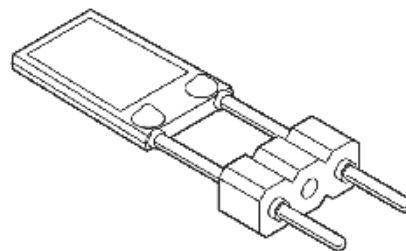

Supplied in Australia by Instrument Choice  
 Call our scientists on 1300 737 871  
[www.instrumentchoice.com.au](http://www.instrumentchoice.com.au)

## Contents

### Measuring Instruments

Practical measuring instruments for humidity		Page
testo 608-H1	Thermohygrometers for uninterrupted measurement	4
testo 608-H2	Thermohygrometer for uninterrupted measurement with alarm	4
testo 605-H1	Thermohygrometer	4
testo 610	Pocket size air moisture and air temperature measuring instrument	5
testo 606-1	Pocket size material moisture meter	6
testo 606-2	Pocket size material moisture/air moisture/temperature measuring instrument	6
testo 616	Fast and non-destructive measurement of material moisture	6
testo 625	Thermohygrometer with flexible probe	8
testo 635-1	The new measurement technology for humidity measurement	9
testo 635-2	New measurement technology for moisture measurement with logger and software	9
testo 845	Infrared Thermometer with Switchable Optics (far-field/close focus)	13
Measurement Data Monitoring System		Page
testo Saveris™	Measurement Data Monitoring System	16
Data loggers		Page
testo 175-H1	2 channel humidity/temperature logger with internal sensors	24
testo 175-H2	2 channel humidity/temperature logger with internal sensors and display	25
testo 177-H1	Humidity/temperature logger, 4 channels, with int. sensors, ext. temperature probe socket and display	26
testostor 171-3	Internal humidity/temperature sensor	28
Ex 171-3	Data logger for Ex zone with internal humidity/temperature sensor	29
testostor 171-2	Internal humidity/temperature sensor with dew point calculation	30
testostor 171-6	2 external humidity/temperature probe sockets or dewpoint calculation	32

### Accessories

Accessories for Data loggers		Page
testo 575	Fast-action printer and logger control in one for testo 175/177	34
Data loggers		Page
testo 580	Compact data collector for readout on site for testo 175/177	35
testo 581	Alarm switching for forwarding alarm reports for testo 175/177	35
Software and Accessories		Page
ComSoft 4 - Basic	Easy operation and convenient analysis for testo 175/177	36
ComSoft 3 - Professional	Pro software incl. data archiving for testo 175/177/171/645/650	37
CFR 21 Part 11	Software for CFR 21 Part 11 requirements for testo 175/177/171	37
Ethernet adapter		Page
Ethernet adapter	Access Ethernet with Testo measuring instruments	38

### Measurement Systems

testo 645	Industrial thermohygrometer	Page 40
testo 650	Reference humidity measuring instrument with psychrometric chart and aw value measurement	Page 42

### Calibration

Huminator	Huminator, accurate humidity generator for climate calibrations	Page 50
-----------	---	---------

## testo 622

## Monitoring indoor climate – quickly, accurately and reliably

In addition to temperature and humidity, the testo 622 also measures pressure.

In the large, clear display, it shows the current measurement values as well as the date and time. It thus provides all important values at a glance.

- Precise measurement of temperature, humidity and pressure
- All important values at a glance: current measurement values as well as date and time
- Calibration and adjustment of the measuring instrument possible on site with the optional calibration and adjustment software
- Large, optimally legible display
- Adjustable calibration reminder function



**testo 622 hygrometer with pressure display, incl. calibration protocol, batteries and attachment material**

Part no.  
**0560 6220**

### Technical data

Meas. range	-10 to +60 °C / 0 to 100 %RH / 300 to 1200 hPa
Resolution	0.1 °C / 0.1 %RH / 0.1 hPa
Accuracy ±1 digit	±0.4 °C / ±2 %RH at +25 °C (10 to 90 %RH) ±3 %RH (remaining range)/ ±3 hPa

Oper. temp.	-10 to +60 °C
Measuring rate	10 s
Battery life	12 months
Storage temp.	-20 to +60 °C
Dimensions	185 x 105 x 36 mm
Weight	240 g (without batteries)

### Accessories

Accessories	Part no.
Calibration and adjustment software with USB cable for testo 622/623	0554 6230
ISO calibration certificate humidity	0520 0006
DKD calibration certificate/humidity	0520 0206

## testo 623

## Monitoring indoor climate – with history function

The new temperature and humidity measuring instrument testo 623 shows current and past temperature and humidity values in a large clear display.

This makes an analysis of the current and past ambient conditions possible, directly on site and without time-consuming analysis on a PC.

- Analysis of past temperature and humidity values directly on site without evaluation on a PC
- Histogram shows current and past temperature or humidity values.
- All important values at a glance: current and past temperature and humidity values as well as date and time
- Large, optimally legible display



**testo 623 hygrometer with history function of the measurement values, incl. calibration protocol, batteries and attachment material**

Part no. **0560 6230** £ **0.00**

### Technical data

Meas. range	-10 to +60 °C / 0 to 100 %RH
Resolution	0.1 °C / 0.1 %RH
Accuracy ±1 digit	±0.4 °C / ±2 %RH at +25 °C (10 to 90 %RH) ±3 %RH (remaining range)

Oper. temp.	-10 to +60 °C
Measuring rate	20 s
Battery life	12 months
Storage temp.	-20 to +60 °C
Dimensions	185 x 105 x 36 mm
Weight	240 g

### Accessories

Accessories	Part no.
Calibration and adjustment software with USB cable for testo 622/623	0554 6230
ISO calibration certificate humidity	0520 0006
DKD calibration certificate/humidity	0520 0206

**testo 608-H1 / testo 608-H2**
**Thermohygrometers for uninterrupted measurement**

The affordable standard testo 608-H1 hygrometer measures humidity, temperature and dewpoint non-stop.

The efficient testo 608-H2 alarm hygrometer with LED alarm function for accurate signals when limits are exceeded.

- With dew point calculation td and max/min display
- Humidity sensor is not affected by condensation
- Battery monitoring
- testo 608-H2, with LED alarm, warns if limits are exceeded
- High accuracy  $\pm 2$  %RH (testo 608-H2)



testo 608-H2, with LED alarm, warns if limits are exceeded

<b>1</b>	<b>testo 608-H1 hygrometer, humidity/dew point/temperature measuring instrument with battery</b>
Part no.	<b>0560 6081</b>

<b>2</b>	<b>Humidity/dewpoint/temp. meas. instr., incl. LED alarm, battery and calibration protocol</b>
Part no.	<b>0560 6082</b>

**Accessories**

ISO calibration certificate humidity, Calibration points 11.3 %RH and 75.3 %RH at +25°C 0520 0006

Technical data		1	2
Meas. range		+10 to +95 %RH 0 to +50 °C -20 to +50 °C td	+2 to +98 %RH -10 to +70 °C -40 to +70 °C td
Accuracy	$\pm 1$ digit	$\pm 3$ %RH (+10 to +95 %RH)	$\pm 2$ %RH (+2 to +98 %RH)
Resolution		0.1 %RH	0.1 %RH
Probe type		NTC	NTC
Accuracy	$\pm 1$ digit	$\pm 0.5$ °C (at +25 °C)	$\pm 0.5$ °C (at +25 °C)
Resolution		0.1 °C	0.1 °C
Oper. temp.		0 to +50 °C	-10 to +70 °C
<b>Common data</b>			
Storage temp.		-40 to +70 °C	
Battery type		9V block battery	
Battery life		8736 h	
Measuring rate		18 s	
Weight		168 g	
Dimensions		120 x 89 x 40 mm	
Warranty		2 years	
Display		LCD, 2 lines	
Material/Housing		ABS	

**testo 605-H1**
**Thermohygrometer**

The thermohygrometer you can bend. Small, compact and accurate. The long-term stable sensor guarantees correct measurement results even after years.

- Dewpoint calculation from -20 to +50 °Ctd
- Long-term stable Testo humidity sensor
- Ideal for measurements in ducts
- Display can be angled for easy readout of measurement values

**testo 605-H1: thermohygrometer with duct holder, incl. attachment clip and battery**

Part no.  
**0560 6053**

**Accessories**

ISO calibration certificate humidity  
Calibration points 11.3 %RH and 75.3 %RH at +25°C 0520 0006

ISO calibration certificate/humidity  
Calibration point 75.3%RH at +25°C 0520 0096

Technical data		
Meas. range	+5 to +95 %RH 0 to +50 °C -20 to +50 °C td	Oper. temp. 0 to +50 °C
Accuracy	$\pm 3$ %RH	Storage temp. -20 to +70 °C
$\pm 1$ digit	$\pm 0.5$ °C	Battery type 3 batteries Type AAA
Resolution	0.1 %RH 0.1 °C	Battery life Approx. 1000 h
		Weight 75 g (with batteries, without packaging)

## testo 610

## Pocket size air moisture and air temperature measuring instrument

testo 610 measures relative air moisture and temperature simultaneously.

Dew point calculation and wet bulb as well as Hold function and max./min. display are possible with this instrument.

testo 610; humidity and temperature measuring instrument incl. protective cap, batteries and calibration protocol

Part no.  
**0560 0610**

- Air moisture and air temperature
- Dewpoint calculation and wet bulb included
- Hold function and max./min. values
- Backlit display
- Long-term stable Testo humidity sensor
- Protective cap for safe storage
- Belt case, wrist strap and calibration protocol included



### Technical data

Meas. range	0 to 100 %RH -10 to +50 °C
Accuracy ±1 digit	±2.5 %RH (5 to 95 %RH) ±0.5 °C
Resolution	0.1 %RH 0.1 °C
Measuring rate	1 s
Weight	90 g (batteries and protective cap included)

Oper. temp.	-10 to +50 °C
Storage temp.	-40 to +70 °C
Battery type	2 batteries Type AAA
Battery life	200 h (average, without display illumination)
Dimensions	119 x 46 x 25 mm (incl. protective cap)
Protection class	IP20

### Accessories

	Part no.
ISO calibration certificate humidity Calibration points 11.3 %RH and 75.3 %RH at +25°C	0520 0006
ISO calibration certificate/temperature temp. data logger; calibration points -8°C; 0°C; +40°C per channel/instrument	0520 0171

## testo 606-1/-2

## Pocket size material moisture/air moisture/temperature measuring instrument

testo 606-1 measures material moisture. Material moisture is displayed in percent by weight using stored material characteristic curves for wood and building materials.

In addition to material moisture, testo 606-2 also measures air moisture and temperature. In this way, drying conditions can be reliably assessed directly on-site

- Accurate wood moisture measurement with stored characteristic curves for beech, spruce, larch, oak, pine, maple
- Additional characteristic curves to locate wet points in building materials for cement screed, concrete, plaster, anhydrite screed, cement mortar, lime mortar, brick
- Hold function for easy readout of readings
- Display illumination
- Protective cap for safe storage
- Belt case, wrist strap and calibration protocol included

### Additional advantages of testo 606-2

- Measurement of temperature and humidity in ambient air
- Incl. dewpoint calculation and wet bulb

**testo 606-1; wood and material moisture meter, incl. protective cap, batteries and calibration protocol**

Part no.  
**0560 6060**

**testo 606-2; wood and material moisture meter with built-in moisture measurement and NTC air thermometer, incl. protective cap, batteries and calibration protocol**

Part no.  
**0560 6062**



### Technical data

	606-1/-2	606-2	
Probe type	Material moisture (based on conductivity)	NTC	Testo humid. sensor, cap.
Meas. range	0 to 50 %	-10 to +50 °C	0 to 100 %RH
Accuracy ±1 digit	±1 %	±0.5 °C	±2.5 %RH (5 to 95 %RH)
Resolution	0.1	0.1 °C	0.1 %RH
Battery life	<b>606-1:</b> 200 h (average, without display illumination) <b>606-2:</b> 130 h (average, without display illumination)		
<b>Common data testo 606-1/-2</b>			
Oper. temp.	-10 to +50 °C	Storage temp.	-40 to +70 °C
Dimensions	119 x 46 x 25 mm (incl. protective cap)	Weight	90 g (protective cap and batteries included)
Battery type	2 batteries Type AAA	Protection class	IP20
Measuring rate	1 s		

### Accessories

	Part no.
<b>For testo 606-1:</b>	
Spare electrodes (1 pair)	On request
<b>For testo 606-2:</b>	
Spare electrodes (1 pair)	On request
ISO calibration certificate humidity	0520 0006
Calibration points 11.3 %RH and 75.3 %RH at +25°C	
ISO calibration certificate/temperature	0520 0171
temp. data logger; calibration points -8°C; 0°C; +40°C per channel/instrument	

## testo 616

## Fast and non-destructive measurement of material moisture

The testo 616 allows fast and non-destructive observation of the material moisture of woods and building materials. This allows the ideal time and place for any destructive measurement which may be necessary to be determined. The display is in percent by weight in comparison to the dry mass of the material.

The testo 616 makes work easier for all those who need to observe the development of drying in floors, walls and surfaces.

- Equipped with 10 characteristics curves for soft wood, hard wood, chipboard, anhydrite screed, cement screed, lime sand brick, aerated concrete, concrete, vertical hole brick and solid brick
- Measurement depth up to 5 cm
- Handy shape for optimum contact pressure
- Hold, max., min. function
- Illuminated digital display
- Characteristics curves were developed in cooperation with the LPI institut

**testo 616, wood and material moisture measuring instrument, incl. battery and calibration protocol**

Part no.  
**0560 6160**



### Accessories

	Part no.
Case for measuring instrument and probes	0516 0210

### Technical data

Measuring range wood:	<50 %	Protection class	IP30
Measuring range building materials:	<20 %	Oper. temp.	+5 to +40 °C/10 to 80 %RH
Measurement principle	capacitive measurement	Storage temp.	-20 to +70 °C
Unit:	Water content in percent by weight based on dry mass (%)	Battery type	9V block battery, 6F22
Resolution	0.1	Battery life	60 h
Measurement depth:	up to 5 cm	Weight	260 g
Measuring rate	0,5 s	Material/Housing	ABS/TPE/Metal
Display refresh	0,5 s	Dimensions	70 x 58 x 234 mm

## testo 625

## Long-Term Drift-Free Thermohygrometer

The compact instrument with built-in humidity probe head for measuring air moisture and temperature. The large 2 line display shows humidity, wet bulb temperature or dewpoint as well as temperature.

When measuring at hard-to-access points, the humidity probe head can be easily removed and attached to the handle via the probe cable (accessory).

Alternatively, the readings can be transmitted wirelessly over wide distances from the probe to the measuring instrument. To do this, the humidity probe head is attached to the radio handle (accessory) and the radio module (accessory) is added to testo 625.

- Displays temperature and relative humidity / wet bulb temperature / dewpoint
- Max./min. values
- Hold button to freeze readings
- Display light
- Auto Off function
- Patented humidity sensor
- 2 year guaranteed long-term stability
- TopSafe, instrument protection against dirt and knocks (optional)

testo 625, humidity/temperature measuring instrument, incl. plug-in humidity probe head, battery and calibration protocol

Part no.  
**0563 6251**



Probe head on handle with probe wire (optional) Auto-Off Funktion



Accessories	Part no.
Handle for plug-in humidity probe head for connection to testo 625, probe cable included (length 120 cm)	0430 9725
Case for measuring instrument and probes	0516 0210
TopSafe, protects from impact and dirt	0516 0221
testo saline pots for control and humidity adjustment of humidity probes, 11.3 %RH and 75.3 %RH with adapter for humidity probe	0554 0660
Lithium battery, button cell, type CR 2032	0515 0028
Recharger for 9V rechargeable battery, for external recharging of 0515 0025 battery	0554 0025
9V rech. battery for instrument, instead of battery	0515 0025
DKD calibration certificate/humidity electronic hygrometers; calibration points 11.3%RH and 75.3%RH at +25°C	0520 0206
ISO calibration certificate humidity Calibration points 11.3 %RH and 75.3 %RH at +25°C	0520 0006

Technical data			
<b>Probe type</b>	NTC	Testo humid. sensor, cap.	
Meas. range	-10 to +60 °C	0 to +100 %RH	
Accuracy	±0.5 °C	±2.5 %RH (+5 to +95 %RH)	
Resolution	0.1 °C	0.1 %RH	
Oper. temp.	-20 to +50 °C	Dimensions	182 x 64 x 40 mm
Storage temp.	-40 to +85 °C	Weight	195 g
Battery type	9V block battery, 6F22	Material/Housing	ABS
Battery life	70 h (without radio operation)	Warranty	2 years

### Radio module for upgrading measuring instrument with radio option

Country versions	Radio freq.	Part no.
Radio module for measuring instrument, 869.85 MHz, approval for the countries: DE, FR, UK, BE, NL, ES, IT, SE, AT, DK, FI, HU, CZ, PL, GR, CH, PT, SI, MT, CY, SK, LU, EE, LT, IE, LV, NO	869.85 MHz FSK	0554 0188
Radio module for measuring instrument, 915.00 MHz FSK, approval for USA, CA, CL	915.00 MHz FSK	0554 0190

### Radio handles, separate

#### Radio handles for humidity probe head

Radio handle for attachable humidity probe head (humidity probe head included in delivery of testo 625)

Country versions	Radio freq.	Part no.
Radio handle for plug-in probe heads, incl. T/C adapter, approval for the countries: DE, FR, UK, BE, NL, ES, IT, SE, AT, DK, FI, HU, CZ, PL, GR, CH, PT, SI, MT, CY, SK, LU, EE, LT, IE, LV, NO	869.85 MHz FSK	0554 0189
Radio handle for plug-in probe heads, incl. T/C adapter, approval for USA, CA, CL	915.00 MHz FSK	0554 0191

#### Radio probes: General technical data

	Radio handle		
Battery type	2 AAA micro batteries	Measuring rate	0.5 s or 10 s, adjustable on handle
Battery life	215 h (meas. rate 0.5 s) 6 months (meas. rate 10 s)	Radio coverage	Up to 20 m (without obstructions)
		Radio transmission	Unidirectional
		Oper. temp.	-20 to +50 °C
		Storage temp.	-40 to +70 °C



## testo 635-1/-2

Long-term drift-free and reliable humidity measurement

The new testo 635 provides the possibility of monitoring and analysing air humidity, material moisture (based on equilibrium humidity), U-value and the pressure dewpoint in compressed air systems.

Versatility with wireless probes

In addition to classical probes with wires, wireless measurement up to a distance of 20 m distance is possible. Damage to the wire or hindrances in usage are thus eliminated. A maximum of three wireless probes can be recorded and displayed by testo 635. The wireless probes are available for the measurement parameters temperature and humidity. The optional easily plugged-in radio module can be retro-fitted at any time.

More user comfort

The testo 635 excels through its logical usage and easy-to-follow menus. When making measurements at different locations, the testo 635-2 offers the advantage that the readings are allocated to the respective measurement location.

For long-term measurements and material moisture measurements, it is possible to switch between different user profiles.

testo 635-2 with store and software

The testo 635-2 has a memory for 10,000 readings. With the testo 635-2, characteristic curves for different materials can be laid down using the PC software included in delivery, and carried over into the instrument. Moisture courses can be recorded, analysed and displayed as a graph or table.

## The new measurement technology for humidity measurement

### Common advantages testo 635-1/-2

- Connection of 3 wireless probes
- Measurement of air humidity, equilibrium humidity and pressure dewpoint in compressed air systems
- Display of dewpoint distance, min., max. and mean values
- Backlit display

### Additional advantages testo 635-1

- Cyclical printing of readings once a minute, for example

### Additional advantages testo 635-2

- Instrument memory for up to 10,000 readings
- PC software for analysis, filing and documentation of measurement data
- Direct display of material moisture due to freely settable characteristics curves (based on equilibrium humidity)
- U-value probe connection option
- Storage of single measurements or measurement series by measurement location
- Fast access to the most important functions via user profiles



#### testo 635-1

testo 635-1, humidity/temperature measuring instrument, with battery and calibration protocol

Part no.  
**0560 6351**

#### testo 635-2

testo 635-2, humidity/temperature measuring instrument with readings memory, PC software and USB data transmission cable, with battery and calibration protocol











Part no.  
**0563 6352**

Accessories	Part no.
<b>Transport and Protection</b>	
Service case for basic equipment of measuring instrument and probes, dimensions: 400 x 310 x 96 mm	0516 0035
Service case for measuring instrument, probe and accessories, dimensions 520 x 380 x 120 mm	0516 0435
Service case for measuring instrument, probes and accessories (505 x 435 x 125 mm)	0516 0235
<b>Additional Accessories and Spare Parts</b>	
Handle for attachable humidity probe head for connection to testo 635, incl. probe wire, for measurement / calibration of humidity probe head	0430 9735
testo saline pots for control and humidity adjustment of humidity probes, 11.3 %RH and 75.3 %RH with adapter for humidity probe	0554 0660
Sintered PTFE filter, Ø 12 mm, for corrosive media High humidity range (long-term measurements), high flow velocities.	0554 0756
Stainless steel sintered cap, Ø 12 mm, is screwed onto humidity probe for measurements at higher flow velocities or in contaminated air	0554 0647
PTFE cap, Ø 5 mm, attachable, PTFE material, (5 off) PTFE, Dust protection, high humidity measurements, high velocities	0554 1031
Adapter for surface humidity measurement, for humidity probes Ø 12mm locates damp spots on walls, for example	0628 0012
Cap for bore holes, for humidity probe Ø 12 mm, Measures equilibrium moisture in bore holes	0554 2140
Plug-in mains adapter, 5 VDC 500 mA with European adapter, 100-250 VAC, 50-60 Hz	0554 0447
Lithium battery, button cell, type CR 2032, Spare Li cell to save RAM data, when changing battery and rech. battery	0515 0028
Adhesive material for fixing and sealing	0554 0761

Accessories	Part no.
<b>Printers and Accessories</b>	
Testo fast printer with wireless infrared interface, 1 roll thermal paper and 4 AA batteries	0554 0549
Spare thermal paper for printer (6 rolls) measurement data documentation legible for up to 10 years	0554 0568
External fast charger for 1-4 AA rech. batteries, incl. 4 Ni-MH rech. batteries with individual cell charging and charge control display, incl. impulse trickle charging, integrated discharge function, with built-in international mains plug, 100-240 V, 300 mA, 50/60 Hz	0554 0610
<b>Calibration Certificates</b>	
ISO calibration certificate humidity Calibration points 11.3 %RH and 75.3 %RH at +25°C	0520 0006
ISO calibration certificate/temperature meas. instr. with surface probe; calibration points +60°C; +120°C; +180°C	0520 0071
ISO calibration certificate dewpoint two adjustment points -10/-40 °Ctd at 6 bar	0520 0136
ISO calibration certificate/absolute pressure, 3 meas. points distributed over meas. range Absolute pressure; accuracy 0.1 to 0.6; 3 points distributed over meas. range (0 to 70 bar)	0520 0185
ISO calibration certificate/humidity cal. points freely selectable from 5 to 95%RH at +15 to +35°C or at -18 to +80°C	0520 0106
DKD calibration certificate/humidity electronic hygrometers; calibration points 11.3%RH and 75.3%RH at +25°C	0520 0206
ISO calibration certificate/U-value probe	0520 0481
DKD calibration certificate/U-value probe	0520 0981

Technical data					
Probe type	Type K (NiCr-Ni)	NTC (Humidity probe)	Testo humid. sensor, cap.	Absolute pressure probe	
Meas. range	-200 to +1370 °C	-40 to +150 °C	0 to +100 %RH	0 to 2000 hPa	
Accuracy ±1 digit	±0.3 °C (-60 to +60 °C) ±(0.2 °C + 0.3% of mv) (remaining range)	±0.2 °C (-25 to +74.9 °C) ±0.4 °C (-40 to -25.1 °C) ±0.4 °C (+75 to +99.9 °C) ±0.5% of mv (remaining range)			
Resolution	0.1 °C	0.1 °C	0.1 %RH	0.1 hPa	

Oper. temp.	-20 to +50 °C
Storage temp.	-30 to +70 °C
Battery type	Alkali manganese, mignon, Type AA
Battery life	200 h
Dimensions	220 x 74 x 46 mm
Weight	428 g
Material/Housing	ABS/TPE/Metal
Warranty	2 years

Humidity probes	Illustration	Meas. range	Accuracy	Part no.	
Humidity/temperature probe	 Ø 12 mm	-20 to +70 °C 0 to +100 %RH	±0.3 °C ±2 %RH (+2 to +98 %RH)	0636 9735	
Robust humidity probe for meas. up to +125 °C, short-term up to +140 °C, Ø 12 mm, e.g. exhaust ducts, and for meas. of material equilibrium moisture, e.g. bulk goods	 300 mm Ø 12 mm	0 to +100 %RH -20 to +125 °C	±2 %RH (+2 to +98 %RH) ±0.2 °C	0636 2161	
Thin humidity probe with built-in electronics, incl. 4 attachable PTFE protection caps for material moisture equilibrium measurement	 60 mm Ø 4 mm	0 to +100 %RH 0 to +40 °C	±2 %RH (+2 to +98 %RH) ±0.2 °C	0636 2135	
Scatter field probe for fast and damage-free material moisture measurement, with probe cable 1.2 m.		Woods: <50 % Building materials: <20 %		0636 6160	
Pressure dewpoint probes	Illustration	Meas. range	Accuracy	t <sub>99</sub>	Part no.
Pressure dewpoint probe for measurements in compressed air systems	 300 mm Fixed cable	-30 ... +50 °C tpd 0 to +100 %RH	±0.9 °C tpd (+0.1 to +50 °C tpd) ±1 °C tpd (-4.9 to 0 °C tpd) ±2 °C tpd (-9.9 to -5 °C tpd) ±3 °C tpd (-19.9 to -10 °C tpd) ±4 °C tpd (-30 to -20 °C tpd)	300 s	0636 9835
Precision pressure dewpoint probe for measurements in compressed air systems, including certificate with test point -40 °C tpd	 300 mm Fixed cable	-60 to +50 °C tpd 0 to +100 %RH	±0.8 °C tpd (-4.9 to +50 °C tpd) ±1 °C tpd (-9.9 to -5 °C tpd) ±2 °C tpd (-19.9 to -10 °C tpd) ±3 °C tpd (-29.9 to -20 °C tpd) ±4 °C tpd (-40 to -30 °C tpd)	300 s	0636 9836
Absolute pressure probes	Illustration	Meas. range	Accuracy	Part no.	
Absolute pressure probe 2000 hPa		0 to +2000 hPa	±5 hPa	0638 1835	
Air probes	Illustration	Meas. range	Accuracy	t <sub>99</sub>	Part no.
Robust air probe, T/C Type K	 115 mm Ø 4 mm Fixed cable	-60 to +400 °C	Class 2*	25 s	0602 1793
Surface probes	Illustration	Meas. range	Accuracy	t <sub>99</sub>	Part no.
Fast-action surface probe with sprung thermocouple strip, also for uneven surfaces, measurement range short-term to +500 °C, TC Type K	 115 mm Ø 5 mm Fixed cable	-60 to +300 °C	Class 2*	3 s	0602 0393
Temperature probe to determine U-value, triple sensor system for measuring wall temperature, modelling clay included		-20 to +70 °C	Class 1; U-value: ±0.1 ±2% of fsv		0614 1635
Note: Only the measuring instrument testo 635-2 is suitable for U-value measurement!			In order to determine the U-value, an additional probe for determining the outside temperature is required: 0613 1001 or 0613 1002 (recommended) or 0602 1793.		

\*According to standard EN 60584-2, the accuracy of Class 2 refers to -40 to +1200 °C.

\*\*when used with an NTC or wireless humidity probe for measuring outside temperature and 20 K difference between the air inside and outside

**Radio module for upgrading measuring instrument with radio option**

Country versions	Radio freq.	Part no.
Radio module for measuring instrument, 869.85 MHz, approval for the countries: DE, FR, UK, BE, NL, ES, IT, SE, AT, DK, FI, HU, CZ, PL, GR, CH, PT, SI, MT, CY, SK, LU, EE, LT, IE, LV, NO	869.85 MHz FSK	0554 0188
Radio module for measuring instrument, 915.00 MHz FSK, approval for USA, CA, CL	915.00 MHz FSK	0554 0190

**Assembled for you: Radio handles with probe head**

Radio handles with probe head for surface measurement	Meas. range	Accuracy	Resolution	t <sub>99</sub>
 Radio handle for attachable probe heads with T/C probe head for surface measurement	-50 to +350 °C Short-term to +500 °C	Radio handle: ±(0.5 °C +0.3% of mv) (-40 to +500 °C) ±(0.7 °C +0.5% of mv) (remaining range) T/C probe head: Class 2	0.1 °C (-50 to +199.9 °C) 1.0 °C (remaining range)	5 s

Country versions	Radio freq.	Part no.
Radio handle for plug-in probe heads, incl. T/C adapter, approval for the countries: DE, FR, UK, BE, NL, ES, IT, SE, AT, DK, FI, HU, CZ, PL, GR, CH, PT, SI, MT, CY, SK, LU, EE, LT, IE, LV, NO	869.85 MHz FSK	0554 0189
T/C probe head for surface measurement, attachable to radio handle, T/C Type K		0602 0394
Radio handle for plug-in probe heads, incl. T/C adapter, approval for USA, CA, CL	915.00 MHz FSK	0554 0191
T/C probe head for surface measurement, attachable to radio handle, T/C Type K		0602 0394

Radio probes incl. humidity probe head	Meas. range	Accuracy	Resolution
 Radio handle for attachable probe heads with humidity probe head	0 to +100 %RH -20 to +70 °C	±2 %RH (+2 to +98 %RH) ±0.3 °C	0.1 %RH 0.1 °C

Country versions	Radio freq.	Part no.
Radio handle for plug-in probe heads, incl. T/C adapter, approval for the countries: DE, FR, UK, BE, NL, ES, IT, SE, AT, DK, FI, HU, CZ, PL, GR, CH, PT, SI, MT, CY, SK, LU, EE, LT, IE, LV, NO	869.85 MHz FSK	0554 0189
Humidity probe head, attachable to radio handle		0636 9736
Radio handle for plug-in probe heads, incl. T/C adapter, approval for USA, CA, CL	915.00 MHz FSK	0554 0191
Humidity probe head, attachable to radio handle		0636 9736

**Radio handles, separate**

Radio handles for attachable T/C probes	Meas. range	Accuracy	Resolution
 Radio handle for attachable probe heads incl. adapter for attaching T/C probes (Type K)	-50 to +1000 °C	±(0.7 °C +0.3% of mv) (-40 to +900 °C) ±(0.9 °C +0.5% of mv) (remaining range)	0.1 °C (-50 to +199.9 °C) 1.0 °C (remaining range)

Country versions	Radio freq.	Part no.
Radio handle for plug-in probe heads, incl. T/C adapter, approval for the countries: DE, FR, UK, BE, NL, ES, IT, SE, AT, DK, FI, HU, CZ, PL, GR, CH, PT, SI, MT, CY, SK, LU, EE, LT, IE, LV, NO	869.85 MHz FSK	0554 0189
Radio handle for plug-in probe heads, incl. T/C adapter, approval for USA, CA, CL	915.00 MHz FSK	0554 0191

**Radio probes: General technical data**

	Radio immersion/penetration probe, NTC	Radio handle	Measuring rate	Radio transmission
Battery type	2 x 3V button cell (CR 2032)	2 AAA micro batteries	0.5 s or 10 s, adjustable on handle	Unidirectional
Battery life	150 h (meas. rate 0.5 s) 2 months (meas. rate 10 s)	215 h (meas. rate 0.5 s) 6 months (meas. rate 10 s)	Radio coverage	Oper. temp. -20 to +50 °C Storage temp. -40 to +70 °C
			Up to 20 m (without obstructions)	

## testo 845 with integrated humidity module

For the first time, surface temperatures with smallest diameters can be measured accurately at short and long distances. The switchable optics for far-field and close focus measurement make this possible.

Far-field measurements are carried out at an optical resolution of 75:1. In this way, surface temperatures can be measured accurately even at great distances from the object to be measured. At a distance of 1.2 metres from the object to be measured, the measuring spot diameter is only 16 mm. A cross laser marks the measuring spot exactly during measurement.

During measurements at a short distance from the object being measured, the close focus optics has a spot diameter of only 1 mm at a distance of 70 mm. Two laser points mark the spot exactly.

## Infrared Thermometer with Switchable Optics (far-field/close focus)

- Switchable optics for far-field measurements (75:1) and close focus (1 mm, distance 70 mm)
- Especially bright cross laser sighting for indicating the actual measurement point
- Integrated humidity module for measuring indoor air humidity and for determining dewpoint distance
- Reference accuracy  $\pm 0.75\text{ }^{\circ}\text{C}$  with super-fast measurement technology (scanning 100 ms)
- Backlit display (3-line), shows  $^{\circ}\text{C}$ , %RH,  $^{\circ}\text{C}$  td, min./max. values, alarm limit values and degree of emission
- Optical and audible alarm when limit values are exceeded
- Probe socket for TC probe for determining emissivity
- Instrument memory for 90 measurement protocols
- PC software for archiving and documenting measurement data (included in delivery)
- Tripod fitting for online measurement via USB cable (included in delivery)
- Measurement data documentation on site with Testo printer



Switch optics 1:  
Far-field 75:1 (16 mm, distance 1200 mm) with cross laser sighting

Switch optics 2:  
Close focus (1 mm, distance 70 mm) with 2-point laser sighting

testo 845, infrared temperature measuring instrument with cross laser sighting incl. humidity module, switchable optics for far-field and close focus measurement, contact temperature probe attachable, optical/audible alarm, reading memory, PC software incl. USB data transfer cable, aluminium case, battery and calibration protocol

Part no.  
**0563 8451**

### Far-field measurement

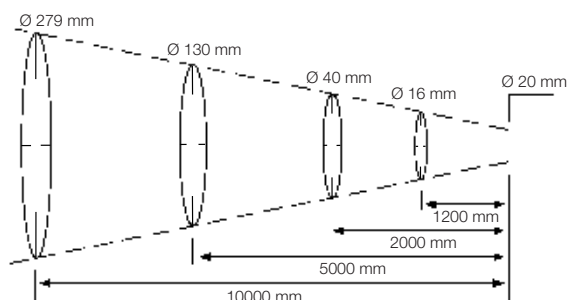

### Close focus measurement

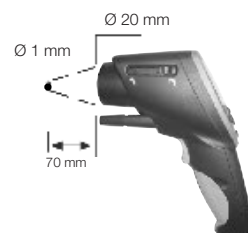















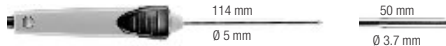
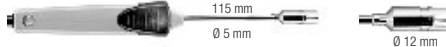
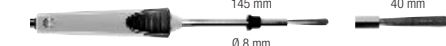
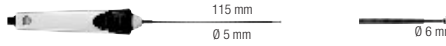

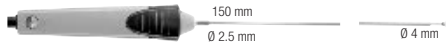
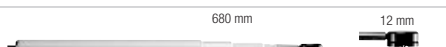
Switch to far-field measurement at a measurement distance > 250 mm.

### Technical data

Probe type	Infrared	Type K (NiCr-Ni)	Humidity module
Meas. range	-35 to +950 $^{\circ}\text{C}$	-35 to +950 $^{\circ}\text{C}$	0 to +100 %RH 0 to +50 $^{\circ}\text{C}$ -20 to +50 $^{\circ}\text{C}$ td
Accuracy $\pm 1$ digit	$\pm 2.5\text{ }^{\circ}\text{C}$ (-35 to -20.1 $^{\circ}\text{C}$ ) $\pm 1.5\text{ }^{\circ}\text{C}$ (-20 to +19.9 $^{\circ}\text{C}$ ) $\pm 0.75\text{ }^{\circ}\text{C}$ (+20 to +99.9 $^{\circ}\text{C}$ ) $\pm 0.75\%$ of mv (+100 to +950 $^{\circ}\text{C}$ )	$\pm 0.75\text{ }^{\circ}\text{C}$ (-35 to +75 $^{\circ}\text{C}$ ) $\pm 1\%$ of mv (+75.1 to +950 $^{\circ}\text{C}$ )	$\pm 2\%$ RH (2 to 98 %RH) $\pm 0.5\text{ }^{\circ}\text{C}$ (+10 to +40 $^{\circ}\text{C}$ ) $\pm 1\text{ }^{\circ}\text{C}$ (remaining range)
Resolution	0.1 $^{\circ}\text{C}$	0.1 $^{\circ}\text{C}$	0.1 $^{\circ}\text{C}$ td
Oper. temp.	-20 to +50 $^{\circ}\text{C}$	Emission factor	Adjustable 0.1 to 1.0
Storage temp.	-40 to +70 $^{\circ}\text{C}$	Material/Housing	black/gray, metal screen
Battery type	2 AA batteries	Optical resolution	Far-field (75:1): 16 mm @ 1200 mm (90%) Near-field (close focus): 1 mm @ 70 mm (90%)
Battery life	25 h (without laser), 10 h (with laser without light), 5 h (with laser and 50% light)	Dimensions	155 x 58 x 195 mm
Measurement rate	t95: 150ms; Scanning Max/Min/Alarm: 100 ms	Weight	465 g
		Warranty	2 years

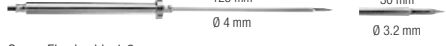
### Accessories

Accessories	Part no.
Plug-in mains adapter, 5 VDC 500 mA with European adapter, 100-250 VAC, 50-60 Hz	0554 0447
External fast charger for 1-4 AA rech. batteries, incl. 4 Ni-MH rech. batteries with individual cell charging and charge control display, incl. impulse trickle charging, integrated discharge function, with built-in international mains plug, 100-240 V, 300 mA, 50/60 Hz	0554 0610
Testo fast printer with wireless infrared interface, 1 roll thermal paper and 4 AA batteries, for printing out measurements on site	0554 0549
Spare thermal paper for printer (6 rolls), measurement data documentation legible for up to 10 years	0554 0568
testo saline pots for control and humidity adjustment of humidity probes, 11.3 %RH and 75.3 %RH with adapter for humidity probe, quick checks or calibration of humidity probe	0554 0660
Adhesive tape, e.g. for bare surfaces (roll, L.: 10 m, W.: 25 mm), E = 0.95, temperature resistant to +250 $^{\circ}\text{C}$	0554 0051
Silicone heat paste (14g), T <sub>max</sub> = +260 $^{\circ}\text{C}$ , improves heat transfer in surface probes	0554 0004
ISO calibration certificate/temperature, infrared thermometer; calibration points +60 $^{\circ}\text{C}$ ; +120 $^{\circ}\text{C}$ ; +180 $^{\circ}\text{C}$	0520 0002
ISO calibration certificate/temperature, Infrared thermometers, calibration points -18 $^{\circ}\text{C}$ , 0 $^{\circ}\text{C}$ , +60 $^{\circ}\text{C}$	0520 0401

Air probes	Illustration	Meas. range	Accuracy	t99	Part no.
Robust air probe, T/C Type K	 115 mm Ø 4 mm Conn.: Fixed cable 1.2 m	-60 to +400 °C	Class 2*	25 s	0602 1793
Immersion/penetr. probes	Illustration	Meas. range	Accuracy	t99	Part no.
Efficient and fast-action immersion probe, waterproof, TC Type K	 Ø 1.5 mm 300 mm Conn.: Fixed cable 1.2 m	-60 to +1000 °C	Class 1*	2 s	0602 0593
Fast-action, waterproof immersion/penetration probe, TC Type K	 60 mm Ø 5 mm 14 mm Ø 1.5 mm Conn.: Fixed cable 1.2 m	-60 to +800 °C	Class 1*	3 s	0602 2693
Immersion tip, flexible, TC Type K	 Ø 1.5 mm 500 mm	-200 to +1000 °C	Class 1*	5 s	0602 5792
Waterproof immersion/penetration probe, TC Type K	 114 mm Ø 5 mm 50 mm Ø 3.7 mm Conn.: Fixed cable 1.2 m	-60 to +400 °C	Class 2*	7 s	0602 1293
Surface probes	Illustration	Meas. range	Accuracy	t99	Part no.
Fast-action surface probe with sprung thermocouple strip, also for uneven surfaces, measurement range short-term to +500°C, TC Type K	 115 mm Ø 5 mm Ø 12 mm Conn.: Fixed cable 1.2 m	-60 to +300 °C	Class 2*	3 s	0602 0393
Fast-reaction paddle surface probe, for measurements in inaccessible places, e.g. narrow apertures and slots, TC Type K	 145 mm Ø 8 mm 40 mm Conn.: Fixed cable	0 to +300 °C	Class 2*	5 s	0602 0193
Waterproof surface probe with widened measurement tip for flat surfaces, T/C Type K	 115 mm Ø 5 mm Ø 6 mm Conn.: Fixed cable 1.2 m	-60 to +400 °C	Class 2*	30 s	0602 1993
Fast-action surface probe with sprung thermocouple strip, bent, also for uneven surfaces, measurement range short-term to +500°C, TC Type K	 80 mm Ø 5 mm 50 mm Ø 12 mm Conn.: Fixed cable 1.2 m	-60 to +300 °C	Class 2*	3 s	0602 0993
Efficient, waterproof surface probe with small measurement head for flat surfaces, TC Type K	 150 mm Ø 2.5 mm Ø 4 mm Conn.: Fixed cable 1.2 m	-60 to +1000 °C	Class 1*	20 s	0602 0693
Flat head surface probe with telescopic handle max. 680 mm for measurements at hard-to-access points, TC Type K	 680 mm 12 mm Ø 25 mm Conn.: Fixed cable 1.6 m (correspondingly shorter when telescope extended)	-50 to +250 °C	Class 2*	3 s	0602 2394
Magnetic probe, adhesive force approx. 20 N, with magnets, for measurements on metal surfaces, TC Type K	 35 mm Ø 20 mm Conn.: Fixed cable 1.6 m	-50 to +170 °C	Class 2*		0602 4792
Magnetic probe, adhesive force approx. 10 N, with magnets, for higher temp., for measurements on metal surfaces, TC Type K	 75 mm Ø 21 mm Conn.: Fixed cable 1.6 m	-50 to +400 °C	Class 2*		0602 4892
Surface probes	Illustration	Meas. range	Accuracy	t99	Part no.
Pipe wrap probe with Velcro strip, for temperature measurement on pipes with diameter up to max. 120 mm, Tmax +120°C, TC Type K	 395 mm 20 mm Conn.: Fixed cable 1.5 m	-50 to +120 °C	Class 1*	90 s	0628 0020
Pipe wrap probe for pipe diameter 5 to 65 mm, with exchangeable measuring head. Meas. range short-term to +280°C, TC Type K	 Conn.: Fixed cable 1.2 m	-60 to +130 °C	Class 2*	5 s	0602 4592
Spare meas. head for pipe wrap probe, TC Type K	 35 mm 15 mm	-60 to +130 °C	Class 2*	5 s	0602 0092
Clamp probe for measurements on pipes, pipe diameter 15 to 25 mm (max. 1"), meas. range short-term up to +130°C, TC Type K	 Conn.: Fixed cable 1.2 m	-50 to +100 °C	Class 2*	5 s	0602 4692
Food probes	Illustration	Meas. range	Accuracy	t99	Part no.
Waterproof food probe made of stainless steel (IP65), TC Type K	 125 mm Ø 4 mm 30 mm Ø 3.2 mm Conn.: Fixed cable 1.2 m	-60 to +400 °C	Class 2*	7 s	0602 2292
Robust food probe with special handle, IP 65, reinforced cable (PUR), T/C Type K	 115 mm Ø 5 mm 30 mm Ø 3.5 mm Conn.: Fixed cable 1.2 m	-60 to +400 °C	Class 1*	6 s	0602 2492
Waterproof robust immersion/penetration probe with metal protection hose Tmax +230°C, e.g. for monitoring temp. in cooking oil, T/C Type K	 240 mm Ø 4 mm Conn.: Fixed cable 1 m	-50 to +230 °C	Class 1*	15 s	0628 1292
Thermocouples	Illustration	Meas. range	Accuracy	t99	Part no.
Thermocouple with TC adapter, flexible, 800mm long, fibre glass, TC Type K	 800 mm Ø 1.5 mm	-50 to +400 °C	Class 2*	5 s	0602 0644

\*According to standard EN 60751, the accuracy of Classes 1/2 refers to -40 to +1000/+1200 °C.



**testo Saveris base**

The base is the heart of testo Saveris and can save 40,000 readings per measurement channel independent of the PC. This corresponds to around one year of memory capacity at a measuring rate of 15 minutes. An emergency battery ensures that an alarm is transmitted and that no existing data is lost in the event of a power failure.

The system data and alarms are visible via the display of the Saveris base. Even without the PC running, the base issues an alarm by means of an LED if the limit value is exceeded, or optionally via SMS and via a relay output to which an alarm transmitter can be connected.

In total, a base can incorporate 150 radio and Ethernet probes or 254 measurement channels. The Saveris base is connected to the PC either via USB or Ethernet cable. The Saveris base thereby offers flexibility with the highest data security.

**testo Saveris wireless probe**

The testo Saveris radio probes measure temperature and humidity. In the measuring cycle, the probes save the recorded measurement data and send it to the central base at regular intervals. If a limit value is exceeded, a radio link is established immediately. Through bidirectional transmission, the radio probe and the base are in mutual contact. This therefore ensures that the measurement data is only recorded by the base and is not interfered with by other radio systems.

An alarm sounds in the event that the radio link be interrupted by obstacles. The memory in the probe ensures that the measurement data is not lost in the event of an interference in the radio link. An optimized battery design ensures for long running life of the probe memory.

In free field, the transmission path is approx. 300 m at a frequency of 868 MHz and approx. 100 m at a frequency of 2.4 GHz. In buildings, the transmission path is strongly influenced by structural conditions such as walls, refrigerator doors or metal doors. The radio link can be improved or lengthened with poor structural conditions by using a router. Because the radio probe and the router show the quality of their radio link, the probe can personally be positioned optimally by the user.

Probe versions with internal and external sensors allow the adaptation to every application. The radio probes are available with or without a display as an option. Current measurement data, the battery status and the quality of the radio link are shown on the display.

**testo Saveris analog coupler**

The two versions of the analog coupler (wireless/Ethernet) allow the inclusion of further measurement parameters into the testo Saveris monitoring system, by integrating all transmitters with standardized current/voltage interfaces, e. g. 4 to 20 mA or 0 to 10 V.

**testo Saveris wireless probe**

**testo Saveris router**
**testo Saveris wireless probe**

**testo Saveris analog coupler (Wireless)**
**testo Saveris wireless probe**
**Saveris set 1**
**Set 1, 868 MHz**

Set 1: 868 MHz, consisting of base 0572 0120, 3 NTC radio probes without display 0572 1110, mains unit for base 0554 1096 and SBE software 0572 0180 incl. USB cable

Part no.

**0572 0110**
**Set 1, 2.4 GHz**

Set 1: 2.4 GHz, consisting of base 0572 0160, 3 NTC radio probes without display 0572 1150, mains unit for base 0554 1096 and SBE software 0572 0180 incl. USB cable

Part no.

**0572 0150**
**Saveris set 2**
**Set 2, 868 MHz**

Set 2: 868 MHz, consisting of base 0572 0120, 5 NTC radio probes with display 0572 1120, router 0572 0119, 2 mains units for base and router 0554 1096 and SBE software 0572 0180 incl. USB cable

Part no.

**0572 0111**
**Set 2, 2.4 GHz**

Set 1: 2.4 GHz, consisting of base 0572 0160, 3 NTC radio probes without display 0572 1150, mains unit for base 0554 1096 and SBE software 0572 0180 incl. USB cable

Part no.

**0572 0151**
**Saveris set 3**
**Set 3, 868 MHz**

Set 3: 868 MHz, consisting of base 0572 0121 incl. GSM module for SMS alarm, aerial with magnetic base 0554 0525, 5 NTC radio probes with display 0572 1120, router 0572 0119, 2 mains units for base and router 0554 1096 and SBE software 0572 0180 incl. USB cable

Part no.

**0572 0112**
**Set 3, 2.4 GHz**

Set 3: 2.4 GHz, consisting of base 0572 0161 incl. GSM module for SMS alarm, aerial with magnetic base 0554 0525, 5 NTC radio probes with display 0572 1160, router 0572 0159, 2 mains units for base and router 0554 1096 and SBE software 0572 0180 incl. USB cable

Part no.

**0572 0152**

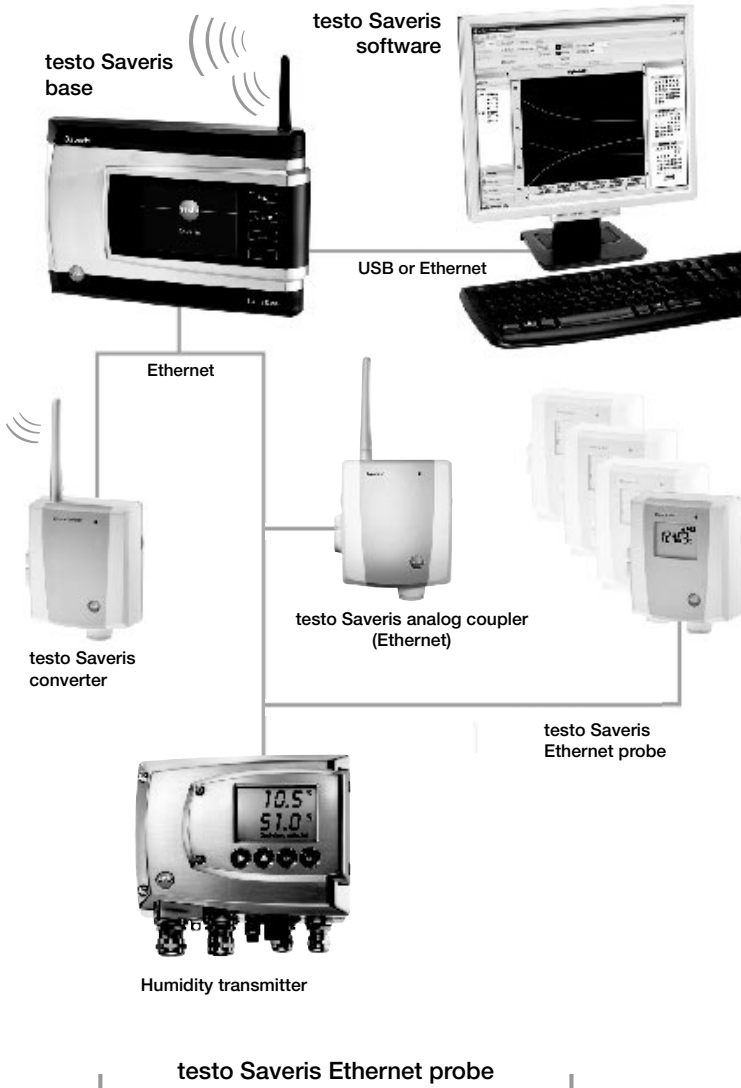

**testo Saveris™**

**testo Saveris Ethernet probe**

In addition to the radio probes, probes can be used that are directly connected to the Ethernet. The existing LAN infrastructure can be used through this. This allows the data transfer from the probe to the base, even over long distances.

Ethernet probes can be used over any long periods since they are connected to the mains and therefore work independently of batteries. The internal memory guarantees that the existing measurement data is not lost, even with failure of the mains or the LAN connection.

A display informs about the current measurement data as well as the probe status. Different probe versions (probe partially plug-in) adapt to the conditions of the application.

Through the connection of a converter to an Ethernet jack, the signal of a radio probe can be converted into an Ethernet signal. This combines the flexible connection of the radio probe with the use of the existing Ethernet even over long transmission paths.

**Humidity transmitter testo 6651/6681**

Thanks to the integration of the humidity transmitter, measurement data monitoring is possible parallel to the control. This provides the solution for highest accuracy as well as for special applications (high humidity, trace humidity etc.) in compressed air, drying and air conditioning technology.

Find out more at [www.testo.com/transmitter](http://www.testo.com/transmitter)

**testo Saveris software**

The measurement data is transmitted from the base to a PC on which the testo Saveris software is installed within just a few minutes using an installation assistant. The initial system and probe configuration is also performed using the software.

All measurement are saved centrally in the software's database and can be called up any time as a table or a graph. All alarms that occur are listed in a table as a history. The automatic creation of PDF reports in defined intervals also simplifies the documentation. Using the calendar function and the consolidation of probes into groups, the operation of the software is simple and intuitive.

In the event of an alarm the user can choose between receiving a message via e-mail or an alarm directly on the screen.

The Saveris software is available in two different versions. The basic version SBE (Small Business Edition) enables the appeal basic functions of the software. Die PROF (Professional) software version offers interesting additional functions, e.g.:

- The integration into the network via Ethernet. Constant monitoring of the measurement data is thereby possible. The measurement data can be monitored by various PCs integrated into the network.
- Photographs of machines or rooms can be saved as a picture. The respective measurement values are shown directly at the position of the probe in the room or at the machine in these. The link between the location and the measurement value is thus very easily visualized (s. picture).
- A comprehensive alarm management offers the option of alarming more than two people at the same time or in succession. Depending on the day of the week and the time, you can freely choose whether an alarm is sent via e-mail or SMS.

Overview of software versions	SBE	PROF	CFR
Simple installation and configuration	•	•	•
Diagrams/tables/alarm overview/PDF reports	•	•	•
Calendar management	•	•	•
Representation of probe groups	•	•	•
Transmission of alarms (e-mail, SMS, relay)	•	•	•
Comprehensive alarm management		•	•
Automatic refresh of measurement data ("Online mode")		•	•
Measurement data on background photo of locations		•	•
Integration into network (client server)		•	•
Conform to 21CFR11 (validatable)			•
Electronic signature			•
Audit trail			•
Allocation of access rights on 3 user levels			•

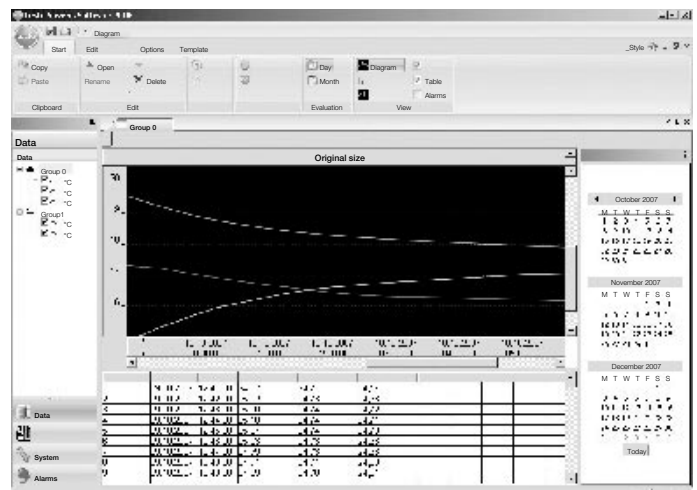

Probe versions with internal and external temperature sensors and with humidity sensors allow the adaptation to every application. The radio probes are available with or without a display as an option. Current measurement data, the battery status and the quality of the radio link are shown in the display.

		°C / °F				
		NTC internal	NTC internal	NTC external	TC external	Pt 100 external
<b>Radio</b>		 81 mm	 81 mm	 81 mm	 81 mm	 81 mm
		<b>Saveris T1</b> Radio probe with internal NTC	<b>Saveris T2</b> Radio probe with external probe connection and internal NTC, door contact	<b>Saveris T3</b> 2-channel radio probe with 2 external TC probe connections (Choice of TC characteristics)	<b>Saveris Pt</b> Radio probe with 1 external Pt100 probe connection	
Internal sensor	Probe type	NTC				
	Meas. range	-35 to +50 °C				
	Accuracy	±0.4 °C (-25 to +50 °C) ±0.8 °C (remaining range)				
	Resolution	0.1 °C				
External probe	Probe type	NTC		TC type K	TC type J	Pt100
	Meas. range (Instrument)	-50 to +150 °C		-195 to +1350 °C	-100 to +750 °C	-200 to +600 °C
	Accuracy (Instrument)	±0.2 °C (-25 to +70 °C) ±0.4 °C (remaining range)		±0.5 °C or 0.5% of mv		at 25 °C ±0.1 °C (0 to +60 °C) ±0.2 °C (-100 to +200 °C) ±0.5 °C (remaining range)
	Resolution (Instrument)	0.1 °C		0.1 °C / TC type S 1 °C		0.01 °C
Conn.		NTC via mini-DIN socket, door contact connection cable included in delivery (1.80 m)		2 TCs via TC socket, max. difference in potential 2 V		1 Pt100 via mini-DIN socket
Dimensions (housing):		80 x 85 x 38 mm				
Weight		Approx. 240 g				
Battery life (Type: 4 AA batteries)		Battery life at +25 °C, 3 years; for freezer applications, 3 years with L91 Photo lithium Energizer batteries)				
Material/Housing		Plastic				
Protection class		IP68		IP54		IP68
Radio frequency		868 MHz / 2.4 GHz				
Measuring rate		Standard 15 min, 1 min to 24 h can be set				
Conformity with standards		DIN EN 12830				
Oper. temp.		-35 to +50 °C		-20 to +50 °C		
Storage temp.		-40 to +55 °C				
Display (optional)		LCD, 2 lines; 7-segment with symbols				
Transmission distance		approx. 300 m free field at a frequency of 868 MHz, approx. 100 m free field at a frequency of 2.4 GHz				
Wall bracket		included				

Ordering data Wireless probes	Part no.		Part no.	
	Version without display		Version with display	
	868 MHz	2.4 GHz	868 MHz	2.4 GHz
Saveris T1 Radio probe with internal NTC	0572 1110	0572 1150	0572 1120	0572 1160
Saveris T2 Radio probe with external probe connection and internal NTC, door contact	0572 1111	0572 1151	0572 1121	0572 1161
Saveris T3 2-channel radio probe with 2 external TC probe connections (Choice of TC characteristics)	0572 9112	0572 9152	0572 9122	0572 9162
Saveris Pt Radio probe with 1 external Pt100 probe connection	0572 7111	0572 7151	0572 7121	0572 7161

The alkali manganese batteries AA (0515 0414) are included in these ordering data (analog coupler excluded). Saveris probes are delivered with a calibration protocol of the factory adjustment data. Calibration certificates must be ordered separately.

**Radio**





		°C / °F and %RH				mA and V	
		%RH NTC external		%RH NTC internal		%RH NTC external	
		Saveris H2D Wireless humidity probe		Saveris H3 Humidity radio probe		Saveris H4D Wireless probe with 1 external humidity probe connection	
						mA V intern	
						Saveris U1 Wireless probe with current/voltage output	
Internal sensor	Probe type			NTC	Humidity sensor		
	Meas. range			-20 to +50 °C	0 to 100 %RH		
	Accuracy			±0.5 °C	±3 %RH		
	Resolution			0.1 °C	0.1 °C / 0.1 °C td		
	Resolution			0.1 °C	0.1 °C / 0.1 °C td		
External probe	Probe type	NTC	Humidity sensor	NTC	Humidity sensor		
	Meas. range (Instrument)	-20 to +50 °C	0 to +100 %RH*	-20 to +70 °C	0 to +100 %RH*		
	Accuracy (Instrument)	±0.5 °C	to 90 %RH: ±2 %RH > 90 %RH: ±3 %RH	±0.2 °C	see probes		
	Resolution (Instrument)	0.1 °C	0.1% / 0.1 °C td	0.1 °C	0.1% / 0.1 °C td		
Conn.	non-exchangeable stump probe			1 x external humidity probe mini DIN socket		2 or 4-wire current/voltage output Service interface mini DIN for adjustment	
Dimensions (housing):	85 x 100 x 38 mm			80 x 85 x 38 mm		Approx. 85 x 100 x 38 mm	
Weight	Approx. 256 g			Approx. 245 g		Approx. 240 g	
Battery life (Type: 4 AA batteries)	Battery life at +25 °C, 3 years; for freezer applications, 3 years with L91 Photo lithium Energizer batteries)					Supply: Mains unit 6.3 V DC, 2 to 30 V DC max. 25 V AC	
Material/Housing	Plastic						
Protection class	IP54		IP42		IP54		
Radio frequency	868 MHz / 2.4 GHz						
Measuring rate	Standard 15 min, 1 min to 24 h can be set						
Oper. temp.	-20 to +50 °C						
Storage temp.	-40 to +55 °C						
Display (optional)	LCD, 2 lines; 7-segment with symbols					(no display)	
Transmission distance	approx. 300 m free field at a frequency of 868 MHz, approx. 100 m free field at a frequency of 2.4 GHz						
Wall bracket	included						

\*not for continuous high-humidity applications

Ordering data Wireless probes	Part no.		Part no.	
	Version without display		Version with display	
	868 MHz	2.4 GHz	868 MHz	2.4 GHz
Saveris H3 Wireless probe with internal humidity sensor	0572 6110	0572 6150	0572 6120	0572 6160
Saveris H2D Wireless probe with external humidity sensor 2%RH, radio frequency 868 MHz (with display)			0572 6122	0572 6162
Saveris H4D Wireless humidity probe with external probe connection, radio frequency 868 MHz (with display)			0572 6124	0572 6164
Saveris U1 Analog coupler with 1 current/voltage output (order mains unit separately)	0572 3110	0572 3150		

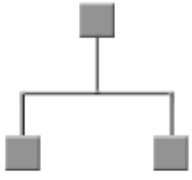
The alkali manganese batteries AA (0515 0414) are included in these ordering data (analog coupler excluded). Saveris probes are delivered with a calibration protocol of the factory adjustment data. Calibration certificates must be ordered separately.

The existing LAN infrastructure can be used through the Ethernet probe. This allows the data transfer from the probe to the base, even over long distances. Ethernet probes have a display.

		°C		
		NTC external	TC external	Pt 100 external
 <b>Ethernet</b>		 <b>Saveris T1E</b> Ethernet probe with 1 external probe connection NTC	 <b>Saveris T4 E</b> 4-channel Ethernet probe with 4 external TC probe connections	 <b>Saveris Pt E</b> Ethernet probe with external Pt100 probe connection
External probe	Probe type	NTC	TC type K	Pt100
	Meas. range (Instrument)	-50 to +150 °C	TC type J TC type T	-200 to +600 °C
	Accuracy (Instrument)	±0.2 °C (-25 to +70 °C) ±0.4 °C (remaining range)	-195 to +1350 °C -100 to +750 °C -200 to +400 °C	at 25 °C ±0.1 °C (0 to +60 °C) ±0.2 °C (-100 to +200 °C) ±0.5 °C (remaining range)
	Resolution (Instrument)	0.1 °C	TC type S 0 to +1760 °C	0.01 °C
Conn.	1 x NTC via mini DIN socket	4 TCs via TC socket, max. difference in potential 50 V	1 Pt100 via mini-DIN socket	
Mini-DIN service interface for adjustment is accessible externally				
Dimensions (housing):		Approx. 85 x 100 x 38 mm		
Weight		Approx. 220 g		
Power		6.3 V DC mains unit; alternatively via 24 V AC/DC plug-in/screw terminals, PoE		
Buffer battery		Li-ion		
Material/Housing		Plastic		
Protection class		IP54		
Measuring rate		2 s to 24 h		
Oper. temp.		-20 to +60 °C		
Storage temp.		-40 to +60 °C		
Power consumption		PoE Class 0 (typical ≤ 3 W)		
Display (optional)		LCD, 2 lines; 7-segment with symbols		
Wall bracket		included		

**Ordering data Ethernet probes**
**Part no.**

Saveris T1E Ethernet probe with 1 external probe connection NTC	0572 1191
Saveris T4 E 4-channel Ethernet probe with 4 external TC probe connections (With display)	0572 9194
Saveris Pt E Ethernet probe with external Pt100 probe connection (With display)	0572 7191
Saveris H1 E Humidity Ethernet probe 1% (With display)	0572 6191
Saveris H2 E Humidity Ethernet probe 2 % (With display)	0572 6192
Saveris H4E Ethernet humidity probe with external probe connection (with display)	0572 6194
Saveris U1E Etheret analog coupler with 1 current/voltage output	0572 3190

Saveris probes are delivered with a calibration protocol of the factory adjustment data. Calibration certificates must be ordered separately. Mains units are not included in delivery.

		°C / °F and %rF						mA and V	
		%RH NTC external		%RH NTC external		%RH NTC external		mA	V
 <b>Ethernet</b>		 <b>Saveris H1E</b> Humidity Ethernet probe 1%		 <b>Saveris H2 E</b> Humidity Ethernet probe 2%		 <b>Saveris H4E</b> Ethernet probe with external humidity probe connection		 <b>Saveris U1E</b> Ethernet probe with current/voltage	
		<b>Internal sensor</b>							
<b>External probe</b>		NTC Meas. range (Instrument) Accuracy (Instrument) Resolution (Instrument)	Humidity sensor 0 to 100 %RH* to 90 %RH: ±(1 %RH +0.7 % of mv) at +25 °C > 90 %RH: ±(1.4 %RH +0.7 % of mv) at +25 °C 0.1% / 0.1 °C td	NTC Meas. range (Instrument) Accuracy (Instrument) Resolution (Instrument)	Humidity sensor 0 to 100 %RH* to 90 %RH: ±(1 %RH +0.7 % of mv) at +25 °C > 90 %RH: ±(1.4 %RH +0.7 % of mv) at +25 °C 0.1% / 0.1 °C td	NTC Meas. range (Instrument) Accuracy (Instrument) Resolution (Instrument)	Humidity sensor 0 to 100 %RH* to 90 %RH: ±(1 %RH +0.7 % of mv) at +25 °C > 90 %RH: ±(1.4 %RH +0.7 % of mv) at +25 °C 0.1% / 0.1 °C td	see external probes	
<b>Conn.</b>		1 x external Ethernet humidity probe mini DIN socket Mini-DIN service interface is accessible externally						1 x 2- or 4-wire current/voltage	
<b>Dimensions (housing):</b>		Approx. 85 x 100 x 38 mm							
<b>Weight</b>		Approx. 230 g		Approx. 254 g		Approx. 240 g			
<b>Power</b>		6.3 V DC mains unit; alternatively via 24 V AC/DC plug-in/screw terminals, PoE							
<b>Buffer battery</b>		Li-ion							
<b>Material/Housing</b>		Plastic							
<b>Protection class</b>		IP54							
<b>Measuring rate</b>		2 s to 24 h							
<b>Oper. temp.</b>		-20 to +60 °C							
<b>Storage temp.</b>		-40 to +60 °C							
<b>Power consumption</b>		PoE Class 0 (typical ≤ 3 W)							
<b>Display (optional)</b>		LCD, 2 lines; 7-segment with symbols						no display	
<b>Wall bracket</b>		included							

\*not for continuous high-humidity applications

**Sintered caps for Saveris H1 E, H2 E and H2 D Ethernet probes**

Metal protection cage, Ø 12 mm for humidity probes, for measurement in flow velocities of less than 10 m/s



Part no. 0554 0755

Stainless steel sintered cap, Ø 12 mm, is screwed onto humidity probe, for measurements at higher flow velocities or in contaminated air

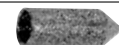

Part no. 0554 0647

Cap with wire mesh filter, Ø 12 mm



Part no. 0554 0757

Sintered PTFE filter, Ø 12 mm, for corrosive media, High humidity range (long-term measurements), high flow velocities.



Part no. 0554 0756

testo saline pots for control and humidity adjustment of humidity probes, 11.3 %RH and 75.3 %RH with adapter for humidity probe, quick checks or calibration of humidity probe

Part no. 0554 0660

testo Saveris™ Base	Part no.
Saveris base, radio frequency 868 MHz	0572 0120
Saveris base, radio frequency 868 MHz, GSM module integrated (for SMS alarm)	0572 0121
Saveris base, radio frequency 2.4 GHz	0572 0160
Saveris base, radio frequency 2.4 GHz, GSM module integrated (for SMS alarm)	0572 0161

No mains units or aerials with magnetic base are contained in this ordering data.



Technical data Base	
Memory	40,000 values per channel (total max. 10,160,000 values)
Dimensions	225 x 150 x 49 mm
Weight	Approx. 1510 g
Protection class	IP42
Material/Housing	Diecast zinc / plastic
Radio frequency	868 MHz / 2.4 GHz
Power supply (absolutely necessary)	6.3 V DC mains unit; alternatively via 24 V AC/DC plug-in/screw terminals, power consumption < 4 W
Rech. batt.	Li-ion battery (for data back-up and for emergency SMS if power supply fails)
Oper. temp.	-10 to +50 °C
Storage temp.	-40 to +60 °C
Display	graphical display, 4 control keys
Interfaces	USB, radio, Ethernet
Connectable radio probe	max. 15 probes can be directly connected via radio interface, max. 150 total via radio / router / converter / Ethernet, max. 254 channels
Alarm relay	max. 1 A, max. 30 W, max. 60/25 V DC/AC, NC or NO contact
GSM module	850 / 900 / 1800 / 1900 MHz not valid for Japan and South Korea
Set up	Table base and wall bracket included

testo Saveris™ Router	Part no.
Saveris router, 868 MHz, radio transmission medium	0572 0119
Saveris router, 2.4 GHz, radio transmission medium	0572 0159

testo Saveris™ Converter	Part no.
Saveris converter, 868 MHz, converts the radio transmission medium to Ethernet	0572 0118
Saveris converter, 2.4 GHz, converts the radio transmission medium to Ethernet	0572 0158

No mains units are contained in this ordering data.

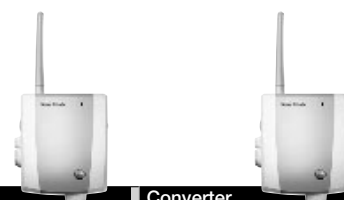

Technical data	Router	Converter
Dimensions	Approx. 85 x 100 x 38 mm	Approx. 85 x 100 x 35 mm
Weight	Approx. 180 g	Approx. 190 g
Power supply	6.3 V DC mains unit; alternatively via 24 V AC/DC plug-in/screw terminals, power consumption < 0.5 W	6.3 V DC mains unit; alternatively via 24 V AC/DC plug-in/screw terminals, PoE, power consumption < 2 W
Oper. temp.	-20 to +50 °C	-20 to +50 °C
Storage temp.	-40 to +60 °C	-40 to +60 °C
Material/Housing	Plastic	Plastic
Protection class	IP54	IP54
Interfaces	Radio	Radio, Ethernet
Connectable radio probe	max. 5	max. 15
Wall bracket	included	included

Note on the radio frequencies			
868 MHz:	EU countries and certain other countries (e.g. CH, NOR)	2.4 GHz:	non-EU countries (country list can be called up under <a href="http://www.testo.com/saveris">www.testo.com/saveris</a> )

Power supply	Part no.
Battery for radio probe (4 AA alkali manganese mignon batteries)	0515 0414
Battery for radio probe for use below -10 °C (4 Energizer L91 Photo lithium)	0515 0572
100-240 V AC / 6.3 V DC international mains unit; for mains operation or battery charging in instrument	0554 1096
Mains unit (top-hat rail mounting) 90 to 264 VAC/24 VDC (2.5 A)	0554 1749
Mains unit (desk-top) 110 to 240 VAC/24 VDC (350mA)	0554 1748

Other features	Part no.
Magnetic foot aerial (dualband) with 3 m cable, for base with GSM module (not suitable for USA, Canada, Chile, Argentina, Mexico)	0554 0524
Magnetic foot aerial (quadband) for base with GSM module	0554 0525
Alarm module (visual + acoustic), can be connected to base alarm relay, Ø 70 x 164 mm, 24 V AC/DC / 320 mA, perm. light: red, perm. tone: buzzer approx. 2.4 kHz (Mains unit 0554 1749 required)	0572 9999 ID-Nr. 0699 6111/1
Programming adapter (from mini-DIN to USB) for Ethernet probe and converter (necessary if no DHCP server available)	0440 6723

Software	Part no.
SBE software, incl. USB connecting cable base-PC	0572 0180
PROF software, incl. USB connecting cable base-PC	0572 0181
CFR software, incl. Ethernet connection cable PC to Base	0572 0182
Saveris adjustment software incl. connection cable for wireless and Ethernet probes	0572 0183

Calibration Certificates	Part no.
ISO calibration certificate/temperature; Temperature probes; calibration points -8 °C; 0 °C; +40 °C per channel/instrument (suitable for Saveris T1/T2)	0520 0171
ISO calibration certificate/temperature; Temperature probes; calibration points -18 °C; 0 °C; +60 °C; per channel/instrument (not suitable for Saveris T1/T2)	0520 0151
DKD calibration certificate/temperature; Temperature probes; calibration points -20 °C; 0 °C; +60 °C; per channel/instrument (not suitable for Saveris T1/T2)	0520 0261
ISO calibration certificate humidity ; calibration points 11.3 %RH and 75.3 %RH at +25 °C/+77 °F; per channel/instrument	0520 0076
DKD calibration cert./humidity; humidity data logger; cal. points 11.3%RH and 75.3%RH at +25°C; per channel/instrument	0520 0246

Pt100 Plug-in probes	Illustration	Meas. range	Accuracy	t99	Part no.
♦ Robust, Pt100 stainless steel food probe (IP65) 	125 mm 15 mm 0.4 mm 0.3 mm Conn.: Fixed cable	-50 to +400 °C	Class A (-50 to +300 °C), Class B (remaining range)	10 s	0609 2272
♦ Robust, waterproof Pt100 immersion/penetration probe 	114 mm 50 mm 0.5 mm 0.37 mm Fixed cable	-50 to +400 °C	Class A (-50 to +300 °C), Class B (remaining range)	12 s	0609 1273
Connection cable for unlimited Pt100 stationary probes with screw terminals (4-wire technology), max. cable length: 20 m					0554 0213
TC Plug-in probes	Illustration	Meas. range	Accuracy	t99	Part no.
Stationary probe with stainless steel sleeve, TC Type K 	40 mm 0.6 mm Conn.: Fixed cable 1.9 m	-50 to +205 °C	Class 2*	20 s	0628 7533
♦ Robust air probe, T/C Type K 	115 mm 0.4 mm Conn.: Fixed cable 1.2 m	-60 to +400 °C	Class 2*	25 s	0602 1793
Magnetic probe, adhesive force approx. 20 N, with magnets, for measurements on metal surfaces, TC Type K 	35 mm 0.20 mm Fixed cable	-50 to +170 °C	Class 2*	150 s	0602 4792
Magnetic probe, adhesive force approx. 10 N, with magnets, for higher temp., for measurements on metal surfaces, TC Type K 	75 mm 0.21 mm Conn.: Fixed cable 1.6 m	-50 to +400 °C	Class 2*		0602 4892
Pipe wrap probe for pipe diameter 5 to 65 mm, with exchangeable measuring head. Meas. range short-term to +280°C, TC Type K 	395 mm 20 mm Conn.: Fixed cable 1.2 m	-60 to +130 °C	Class 2*	5 s	0602 4592
Pipe wrap probe with Velcro strip, for temperature measurement on pipes with diameter up to max. 120 mm, Tmax +120°C, TC Type K 	395 mm 20 mm Conn.: Fixed cable 1.5 m	-50 to +120 °C	Class 1*	90 s	0628 0020
Thermocouple with TC adapter, flexible, 800mm long, fibre glass, TC Type K 	800 mm 0.15 mm	-50 to +400 °C	Class 2*	5 s	0602 0644
Thermocouple with TC adapter, flexible, 1500mm long, fibre glass, TC Type K 	1500 mm 0.15 mm	-50 to +400 °C	Class 2*	5 s	0602 0645
Thermocouple with TC adapter, flexible, 1500mm long, PTFE, TC Type K 	1500 mm 0.15 mm	-50 to +250 °C	Class 2*	5 s	0602 0646
Immersion tip, flexible, TC Type K 	500 mm 0.15 mm	-200 to +1000 °C	Class 1*	5 s	0602 5792
Immersion measurement tip, flexible, for measurements in air/exhaust gases (not suitable for measurements in smelters), TC Type K 	1000 mm 0.3 mm	-200 to +1300 °C	Class 1*	4 s	0602 5693
*According to standard EN 60584-2, the accuracy of Class 1 refers to -40 to +1000 °C (Type K), Class 2 to -40 to +1200 °C (Type K), Class 3 to -200 to +40 °C (Type K).					
NTC Plug-in probes	Illustration	Meas. range	Accuracy	t99	Part no.
Stub probe, IP 54 	35 mm 0.3 mm	-20 to +70 °C	±0.2 °C (-20 to +40 °C) ±0.4 °C (+40.1 to +70 °C)	15 s	0628 7510
Stationary probe with aluminium sleeve, IP 65 	40 mm 0.6 mm Conn.: Fixed cable; Cable/length: 2.4 m	-30 to +90 °C	±0.2 °C (0 to +70 °C) ±0.5 °C (remaining range)	190 s	0628 7503*
Accurate imm./pen. probe, 6m cable, IP 67 	40 mm 0.3 mm Conn.: Fixed cable; Cable/length: 6 m	-35 to +80 °C	±0.2 °C (-25 to +74.9 °C) ±0.4 °C (remaining range)	5 s	0610 1725*
Accurate immersion/penetration probe, cable: 1.5 m long, IP 67 	40 mm 0.3 mm Conn.: Fixed cable; Cable/length: 1.5 m	-35 to +80 °C	±0.2 °C (-25 to +74.9 °C) ±0.4 °C (remaining range)	5 s	0628 0006*
Wall surface temperature probe, e.g. to prove damage in building material 	40 mm 0.3 mm Conn.: Fixed cable; Cable/length: 3 m	-50 to +80 °C	±0.2 °C (0 to +70 °C)	20 s	0628 7507
Stainless steel NTC food probe (IP65) with PUR cable 	125 mm 15 mm 0.4 mm 0.3 mm Conn.: Fixed cable; Cable/length: 1.6 m	-50 to +150 °C <sup>2)</sup>	±0.5% of mv (+100 to +150 °C) ±0.2 °C (-25 to +74.9 °C) ±0.4 °C (remaining range)	8 s	0613 2211*
♦ Waterproof NTC immersion/penetration probe 	115 mm 50 mm 0.5 mm 0.4 mm Conn.: Fixed cable	-50 to +150 °C	±0.5% of mv (+100 to +150 °C) ±0.2 °C (-25 to +74.9 °C) ±0.4 °C (remaining range)	10 s	0613 1212
Pipe wrap probe with Velcro for pipe diameter to max. 75 mm, Tmax. +75°C, NTC 	300 mm 30 mm Conn.: Fixed cable; Cable/length: 1.5 m	-50 to +70 °C	±0.2 °C (-25 to +70 °C) ±0.4 °C (-50 to -25.1 °C)		0613 4611
* Probe tested to EN 12830 for suitability in the transport and storage sectors		2) Long-term measurement range +125°C, short-term +150°C or +140°C (2 minutes)			
%RH Plug-in probes	Illustration	Meas. range	Accuracy	Part no.	
♦ Humidity / Temperature Probe 12mm 	0.12 mm	-20 to +70 °C, 0 to +100 %RH	±0.3 °C, ±2 %RH (2 to 98 %RH)	0572 6172	
♦ Humidity / Temperature Probe 4 mm 	0.4 mm	0 to +40 °C, 0 to +100 %RH	±0.3 °C, ±2 %RH (2 to 98 %RH)	0572 6174	

♦ The specified accuracy class of the Saveris radio and Ethernet probe is achieved using these external probes.

## testo 175-H1

## Internal humidity/temperature sensor

The affordable testo 175-H1 humidity/temperature logger monitors ambient humidity and temperature fluctuations efficiently and unobtrusively.

Limit values can be entered, an alarm display is activated if the limits are exceeded. testo 575, the fast printer, supplies proof of fluctuations in ambient conditions.

- Humidity sensor guaranteed long-term stable
- Non-volatile memory for secure data, even if battery is spent
- Fast documentation on the infrared printer, 6 lines/sec.
- Data transfer to PC or notebook via interface or testo 580 data collector

### testo 175-H1 without display

testo 175-H1, humidity/temperature logger, 2 channels, with internal sensors, wall holder and calibration protocol; calibration certificates (ISO/DKD) must be ordered separately

Part no.

**0563 1757**

Accessories	Part no.
<b>Transport and Protection</b>	
Lock for wall holder for testo 175/177 data loggers	0554 1755

Additional Accessories and Spare Parts	Part no.
Battery, 3.6 V/0.8 Ah 1/2 AA, for testo 175-T3/175-H1/175-H2/175-S1/175-S2	0515 0175

testo 580 data collector set with RS232, readout holders included, for testo 175/177 data loggers	0554 1778
---	-----------

testo 580 data collector set with USB, readout holders included, for testo 175/177 data loggers	0554 1764
---	-----------

testo 581 alarm signal output, floating, for testo 175/177, forwards information efficiently when limits are exceeded to e.g. horns, lamps, PLC etc.	0554 1769
--	-----------

Printers and Accessories	Part no.
Fast testo 575 printer, incl. 1 roll of thermal paper and batteries, infrared thermal line printer with graphics function	0554 1775
Spare thermal paper for printer (6 rolls)	0554 0569

Spare thermal paper for printer (6 rolls), measurement data documentation legible for up to 10 years	0554 0568
--	-----------

Label thermal paper (Testo patent) for testo 575 printer (6 rolls), can be applied directly	0554 0561
---	-----------

Software and Accessories	Part no.
ComSoft 4 Set - Basic with RS232 interface, Basic software with diagram and table function, incl. desk-top holder, PC connection cable	0554 1759

ComSoft 4 - Basic Set with USB interface for testo 175, Basic software with diagram and table function, incl. desk-top holders, PC connection cable	0554 1766
---	-----------

ComSoft 3 - Professional with data management, incl. database, analysis and graphics function, data analysis, trend curve (without interface)	0554 0830
---	-----------

ComSoft 3 - For requirements to CFR 21 Part 11, incl. database, analysis and graphics function, data analysis, trend curve (w/o interface)	0554 0821
--	-----------

RS232 interface for testo 175/177 incl. desk-top holders, PC connection cable, (please also order for ComSoft 3 - Professional)	0554 1757
---	-----------

USB interface, for testo 175/177 incl. desk-top holders, PC conn. cable, (Please order with ComSoft 3 - Professional)	0554 1768
---	-----------

Ethernet adapter, RS232 - Ethernet incl. software driver, mains unit, facilitates data communication in network	0554 1711
---	-----------



testo 175-H1 without display (illustration actual size)

Accessories	Part no.
<b>Calibration Certificates</b>	
ISO calibration certificate/temperature; temp. data logger; calibration points -8°C; 0°C; +40°C per channel/instrument	0520 0171
ISO calibration certificate humidity, calibration points 11.3 %RH and 75.3 %RH at +25 °C/+77 °F; per channel/instrument	0520 0076
DKD calibration cert./humidity, humidity data logger; cal. points 11.3%RH and 75.3%RH at +25°C; per channel/instrument	0520 0246
DKD calibration certificate/temperature, Temperature probe; cal. points -20°C; 0°C; +60°C (-4 °F, 92 °F, 140 °F); per channel/instrument	0520 0261

*\*Limited functionality*

Technical data	
Meas. range Temperature (NTC)	-10 to +50 °C
Accuracy	±0.5 °C ±1 digit
Resolution	0.1 °C
Meas. range Testo humid. sensor, cap.	0 to +100 %RH
Accuracy	±3 %RH ±1 digit
Resolution	0.1 %RH
Oper. temp.	-10 to +50 °C
Storage temp.	-40 to +70 °C
Memory	3700
Weight	80 g
Battery type	Lithium battery
Dimensions	82 x 52 x 30 mm
Warranty	2 years
Battery life: 2.5 years with a measuring rate of 15 min (-10 to +50°C)	
Measuring rate: 10 s to 24 h	
Software: Microsoft Windows 95b / 98 / ME / 2000 / XP / Vista	





## testo 175-H2

The compact humidity/temperature logger with display. It provides you with a fast on-site overview of current readings, the last values saved, max and min values and the number of times limits were exceeded.

The testo 575 printer provides fast proof of adherence to prescribed ambient storage or production conditions. All of the values collected by the testo 580 data collector are transmitted to your PC for analysis.

### testo 175-H2 with display

testo 175-H2, humidity/temperature logger, 2 channels, with internal sensors, wall holder and calibration protocol; calibration certificates (ISO/DKD) must be ordered separately

Part no.

**0563 1758**

## Internal humidity/temperature sensor and display

- Humidity sensor guaranteed long-term stable
- Non-volatile memory for secure data, even if battery is spent
- Fast documentation on the infrared printer, 6 lines/sec.
- Data transfer to PC or notebook via interface or testo 580 data collector
- Large display, can also be read at a distance (testo 175-H2)



testo 175-H2 with display (illustration actual size)

Accessories	Part no.
<b>Transport and Protection</b>	
Lock for wall holder for testo 175/177 data loggers	0554 1755
<b>Additional Accessories and Spare Parts</b>	
Battery, 3.6 V/0.8 Ah 1/2 AA, for testo 175-T3/175-H1/175-H2/175-S1/175-S2	0515 0175
testo 580 data collector set with RS232, readout holders included, for testo 175/177 data loggers	0554 1778
testo 580 data collector set with USB, readout holders included, for testo 175/177 data loggers	0554 1764
testo 581 alarm signal output, floating, for testo 175/177, forwards information efficiently when limits are exceeded to e.g. horns, lamps, PLC etc.	0554 1769
<b>Printers and Accessories</b>	
Fast testo 575 printer, incl. 1 roll of thermal paper and batteries, infrared thermal line printer with graphics function	0554 1775
Spare thermal paper for printer (6 rolls)	0554 0569
Spare thermal paper for printer (6 rolls), measurement data documentation legible for up to 10 years	0554 0568
Label thermal paper (Testo patent) for testo 575 printer (6 rolls), can be applied directly	0554 0561
<b>Software and Accessories</b>	
ComSoft 4 Set - Basic with RS232 interface, Basic software with diagram and table function, incl. desk-top holder, PC connection cable	0554 1759
ComSoft 4 - Basic Set with USB interface for testo 175, Basic software with diagram and table function, incl. desk-top holders, PC connection cable	0554 1766
ComSoft 3 - Professional with data management, incl. database, analysis and graphics function, data analysis, trend curve (without interface)	0554 0830
ComSoft 3 - For requirements to CFR 21 Part 11, incl. database, analysis and graphics function, data analysis, trend curve (w/o interface)	0554 0821
RS232 interface for testo 175/177 incl. desk-top holders, PC connection cable, (please also order for ComSoft 3 - Professional)	0554 1757
USB interface, for testo 175/177 incl. desk-top holders, PC conn. cable, (Please order with ComSoft 3 - Professional)	0554 1768
Ethernet adapter, RS232 - Ethernet incl. software driver, mains unit, facilitates data communication in network	0554 1711

Accessories	Part no.
<b>Calibration Certificates</b>	
ISO calibration certificate/temperature; temp. data logger; calibration points -8°C; 0°C; +40°C per channel/instrument	0520 0171
ISO calibration certificate humidity, calibration points 11.3 %RH and 75.3 %RH at +25 °C/+77 °F; per channel/instrument	0520 0076
DKD calibration cert./humidity, humidity data logger; cal. points 11.3%RH and 75.3%RH at +25°C; per channel/instrument	0520 0246
DKD calibration certificate/temperature, Temperature probe; cal. points -20°C; 0°C; +60°C (-4 °F, 92 °F, 140 °F); per channel/instrument	0520 0261

*\*Limited functionality*

Technical data	
Meas. range Temperature (NTC)	-20 to +70 °C
Accuracy	±0.5 °C ±1 digit
Resolution	0.1 °C
Meas. range Testo humid. sensor, cap.	0 to +100 %RH
Accuracy	±3 %RH ±1 digit
Resolution	0.1 %RH
Oper. temp.	-20 to +70 °C
Storage temp.	-40 to +85 °C
Memory	16000
Weight	85 g
Battery type	Lithium battery
Dimensions	82 x 52 x 30 mm
Warranty	2 years
Battery life: 2.5 years with a measuring rate of 15 min (-10 to +50°C)	
Measuring rate: 10 s to 24 h	
Software: Microsoft Windows 95b / 98 / ME / 2000 / XP / Vista	

## testo 177-H1

Sensitive products require the right ambient conditions during production and storage. Efficient measurement and documentation of readings over months/years is possible with the professional testo 177-H1 data logger.

Additional surface, immersion and air probes can be attached to the data logger e.g. for uninterrupted measurement of the dewpoint difference.

testo 177-H1, humidity/temperature logger, 4 channels, with internal sensors and additional external temp. probe socket, wall holder and calibration protocol; calibration certificates (ISO/DKD) must be ordered separately

Part no.  
**0563 1775**

## Humidity/temperature logger, 4 channels, with int. sensors, ext. temperature probe socket and display

- Long-term stable humidity sensor with fast response time
- Control and adjustment option with adjustment set
- Protective caps for dirty air or corrosive gases
- Convenient documentation with infrared printer or PC/notebook
- Memory for up to 48,000 readings







Probes (NTC)	Illustration	Meas. range	Accuracy	t99	Part no.
Stub probe, IP 54	35 mm 0.3 mm	-20 to +70 °C	±0.2 °C (-20 to +40 °C) ±0.4 °C (+40.1 to +70 °C)	15 s	0628 7510
Stationary probe with aluminium sleeve, IP 65	40 mm 0.6 mm Conn.: Fixed cable; Cable/length: 2.4 m	-30 to +90 °C	±0.2 °C (0 to +70 °C) ±0.5 °C (remaining range)	190 s	0628 7503*
Accurate imm./pen. probe, 6m cable, IP 67	40 mm 0.3 mm Conn.: Fixed cable; Cable/length: 6 m	-35 to +80 °C	±0.2 °C (-25 to +74.9 °C) ±0.4 °C (remaining range)	5 s	0610 1725*
Accurate immersion/penetration probe, cable: 1.5 m long, IP 67	40 mm 0.3 mm Conn.: Fixed cable; Cable/length: 1.5 m	-35 to +80 °C	±0.2 °C (-25 to +74.9 °C) ±0.4 °C (remaining range)	5 s	0628 0006*
Screw-in probes for measurements at hard-to-access points, M6 thread, IP 54	40 mm 8 x 8 mm Conn.: Fixed cable; Cable/length: 2 m	-50 to +80 °C	±0.5% of mv	70 s	0628 7514*
Probe for surface measurement	40 mm 8 x 8 mm Conn.: Fixed cable; Cable/length: 2 m	-50 to +80 °C	±0.2 °C (0 to +70 °C)	150 s	0628 7516*
Wall surface temperature probe, e.g. to prove damage in building material	30 mm 0.3 mm Conn.: Fixed cable; Cable/length: 3 m	-50 to +80 °C	±0.2 °C (0 to +70 °C)	20 s	0628 7507
Pipe wrap probe with Velcro for pipe diameter to max. 75 mm, Tmax. +75°C, NTC	300 mm 30 mm Conn.: Fixed cable; Cable/length: 1.5 m	-50 to +70 °C	±0.2 °C (-25 to +70 °C) ±0.4 °C (-50 to -25.1 °C)		0613 4611
Stainless steel NTC food probe (IP65) with PUR cable	125 mm 0.4 mm Conn.: Fixed cable; Cable/length: 1.6 m	-50 to +150 °C <sup>2)</sup>	±0.5% of mv (+100 to +150 °C) ±0.2 °C (-25 to +74.9 °C) ±0.4 °C (remaining range)	8 s	0613 2211*
Robust NTC food penetration probe with special handle, reinforced PUR cable	115 mm 0.5 mm Conn.: Fixed cable; Cable/length: 1.26 m	-25 to +150 °C <sup>2)</sup>	±0.5% of mv (+100 to +150 °C) ±0.2 °C (-25 to +74.9 °C) ±0.4 °C (remaining range)	7 s	0613 2411*
Frozen food probe NTC, corkscrew design (incl. plug-in wire)	110 mm 0.8 mm Conn.: Plug-in cable 1.5 m	-50 to +140 °C <sup>2)</sup>	±0.5% of mv (+100 to +140 °C) ±0.2 °C (-25 to +74.9 °C) ±0.4 °C (remaining range)	20 s	0613 3211*
● Efficient, robust NTC air probe	115 mm 0.5 mm Conn.: Fixed cable 1.2 m	-50 to +125 °C	±0.2 °C (-25 to +80 °C) ±0.4 °C (remaining range)	60 s	0613 1712

The specified seal class of the data loggers is achieved with these probes.

\* Probe tested to EN 12830 for suitability in the transport and storage sectors  
2) Long-term measurement range +125°C, short-term +150°C or +140°C (2 minutes)

**testo 177-H1**
**Accessories / Technical data**

Accessories	Part no.
<b>Transport and Protection</b>	
Transport case for up to 6 testo 177 data loggers, testo 575 printer, testo 580 data collector and accessories	0516 1770
Lock for wall holder for testo 175/177 data loggers	0554 1755
<b>Additional Accessories and Spare Parts</b>	
Battery, 3.6 V/1.9 Ah 1AA, for testo 175-T1/175-T2 and all testo 177 loggers	0515 0177
testo 580 data collector set with RS232, readout holders included, for testo 175/177 data loggers	0554 1778
testo 580 data collector set with USB, readout holders included, for testo 175/177 data loggers	0554 1764
testo 581 alarm signal output, floating, for testo 175/177, forwards information efficiently when limits are exceeded to e.g. horns, lamps, PLC etc.	0554 1769
<b>Printers and Accessories</b>	
Fast testo 575 printer, incl. 1 roll of thermal paper and batteries, infrared thermal line printer with graphics function	0554 1775
Spare thermal paper for printer (6 rolls)	0554 0569
Spare thermal paper for printer (6 rolls), measurement data documentation legible for up to 10 years	0554 0568
Label thermal paper (Testo patent) for testo 575 printer (6 rolls), can be applied directly	0554 0561
<b>Software and Accessories</b>	
ComSoft 4 Set - Basic with RS 232 interface for testo 177, Basic software with diagram and table function, incl. desk-top holder, PC connection cable	0554 1774
ComSoft 4 - Basic Set with USB interface for testo 177, Basic software with diagram and table function, incl. desk-top holders, PC connection cable	0554 1767
ComSoft 3 - Professional with data management, incl. database, analysis and graphics function, data analysis, trend curve (without interface)	0554 0830
ComSoft 3 - For requirements to CFR 21 Part 11, incl. database, analysis and graphics function, data analysis, trend curve (w/o interface)	0554 0821
RS232 interface for testo 175/177 incl. desk-top holders, PC connection cable, (please also order for ComSoft 3 - Professional)	0554 1757
USB interface, for testo 175/177 incl. desk-top holders, PC conn. cable, (Please order with ComSoft 3 - Professional)	0554 1768
Ethernet adapter, RS232 - Ethernet incl. software driver, mains unit, facilitates data communication in network	0554 1711
<b>Accessories: Humidity probes</b>	
Metal protection cage, Ø 12 mm for humidity probes, for measurement in flow velocities of less than 10 m/s	 0554 0755
Cap with wire mesh filter, Ø 12 mm	 0554 0757
Sintered PTFE filter, Ø 12 mm, for corrosive media, High humidity range (long-term measurements), high flow velocities.	 0554 0756
Stainless steel sintered cap, Ø 12 mm, is screwed onto humidity probe, for measurements at higher flow velocities or in contaminated air	 0554 0647
testo saline pots for control and humidity adjustment of humidity probes, 11.3 %RH and 75.3 %RH with adapter for humidity probe, quick checks or calibration of humidity probe	0554 0660

Accessories	Part no.
<b>Calibration Certificates</b>	
ISO calibration certificate/temperature, temperature probe; calibration points -18°C; 0°C; +60°C per channel/instrument	0520 0151
ISO calibration certificate humidity, calibration points 11.3 %RH and 75.3 %RH at +25 °C/+77 °F; per channel/instrument	0520 0076
DKD calibration cert./humidity, humidity data logger; cal. points 11.3%RH and 75.3%RH at +25°C; per channel/instrument	0520 0246

\*Limited functionality

Technical data				
Probe type	NTC (Internal)	NTC (External)	Testo humid. sensor, cap.	Dewpoint calculated
Meas. range	-20 to +70 °C	-40 to +120 °C	0 to +100 %RH	-40 to +70 °C td
Accuracy ±1 digit	±0.5 °C	±0.2 °C (-25 to +70 °C) ±0.4 °C (remaining range)	±2 %RH	
Resolution	0.1 °C	0.1 °C	0.1 %RH	0.1 °C td

Oper. temp.	-20 to +70 °C	Battery life: 5 years with a measuring rate of 15 min (-10 to +50°C)
Storage temp.	-40 to +85 °C	
Battery type	Lithium battery	Measuring cycle: 2 s to 24 h
Protection class	IP54	Software: Microsoft Windows 95b / 98 /ME / 2000 / XP / Vista
Memory	48000	
Weight	130 g	
Dimensions	103 x 64 x 33 mm	
Warranty	2 years	

## testostor 171-3

## Internal humidity/temperature sensor

testostor 171-3, a compact data logger with an internal humidity/temperature probe which can be quickly positioned directly on site.

The saved data can be documented on site on the Testo printer or can be analysed on your PC via interface and software.

testostor 171-3, humidity data logger for %RH, °C with starting magnet, battery and calibration protocol; calibration certificates (ISO/DKD) must be ordered separately

Part no.

**0577 1713**

- Attachable display, checks readings on site
- Control and adjustment option using adjustment set
- Measuring cycle: 2 s to 24 h, selectable
- Easy battery replacement
- DKD calibration possible
- Sintered cap protection for dusty environments (see Accessories)
- Suitable for outdoor use
- Protection class IP65
- Data analysis on PC



Accessories	Part no.
-------------	----------

Transport and Protection	
--------------------------	--

Transport case (plastic) for measurement data storage instruments (max. 6 off) and accessories, for safe transport	0516 0117
--	-----------

Holder with lock for data logger, theft-proof	0554 1782
---	-----------

Stainless steel sintered cap, Ø 21 mm, can be screwed onto humidity probe, protection in case of high mechanical load and high velocities	0554 0640
---	-----------

Additional Accessories and Spare Parts	
--	--

Spare battery for testostor 171, quick and easy battery replacement	0515 0018
---	-----------

testo saline pots for control and humidity adjustment of humidity probes, 11.3 %RH and 75.3 %RH with adapter for humidity probe, quick checks or calibration of humidity probe	0554 0660
--	-----------

Software and Accessories	
--------------------------	--

ComSoft 3 - Professional with data management, incl. database, analysis and graphics function, data analysis, trend curve	0554 0830
---	-----------

ComSoft 3 - For requirements to CFR 21 Part 11, incl. database, analysis and graphics function, data analysis, trend curve (w/o interface)	0554 0821
--	-----------

Interface, attachable to testostor 171 data logger	0554 1781
--	-----------

Ethernet adapter, RS232 - Ethernet incl. software driver, mains unit, facilitates data communication in network	0554 1711
---	-----------

Calibration Certificates	
--------------------------	--

ISO calibration certificate/temperature, temp. data logger; calibration points -8°C; 0°C; +40°C per channel/instrument	0520 0171
--	-----------

DKD calibration cert./humidity, humidity data logger; cal. points 11.3%RH and 75.3%RH at +25°C; per channel/instrument	0520 0246
--	-----------

ISO calibration certificate humidity, calibration points 11.3 %RH and 75.3 %RH at +25 °C/+77 °F; per channel/instrument	0520 0076
---	-----------

Set	Part no.
-----	----------

Set testostor 171-3, incl. humidity data logger for %RH, °C with starting magnet, battery, calibration protocol and software with interface; calibration certificates (ISO/DKD) must be ordered separately	0563 1713
--	-----------

Technical data		
----------------	--	--

Probe type	NTC	Testo humid. sensor, cap.
Meas. range	-10 to +50 °C	0 to +100 %RH
Accuracy ±1 digit	±0.5 °C (-10 to +39.9 °C) ±0.6 °C (+40 to +50 °C)	±3 %RH (+2 to +98 %RH)
Resolution	0.1 °C	0.1 %RH
Oper. temp.	-20 to +70 °C	Protection class IP65
Storage temp.	-40 to +85 °C	Warranty 2 years
Memory	20000	Measuring rate: 2 s to 24 h, selectable
Material/Housing	Aluminium, anodized	Battery life: up to 5 years
Battery type	Lithium battery	Software: menu-driven from Microsoft Windows 95 / ME / 2000 / XP / Vista
Dimensions	131 x 68 x 84 mm	
Weight	320 g	



## Ex 171-3

## Data logger for Ex zone with internal humidity/temperature sensor

The Ex 171-3, in its extremely robust metal housing, guarantees a high measuring accuracy level for long-term measurements in hazardous areas.

The interface to download the data to your PC is attached outside the hazard area. The data is analysed in table or graph form via easy-to-use software.

Ex 171-3, humidity data logger %RH, °C, incl. starting magnet, battery and calibration protocol; calibration certificates (ISO/DKD) must be ordered separately

Part no.  
**0577 1733**

- Tamper-proof readings
- Theft-proof mounting
- Control and adjustment option with adjustment set



TÜV 00 ATEX 1586

Accessories	Part no.
<b>Transport and Protection</b>	
Transport case (plastic) for measurement data storage instruments (max. 6 off) and accessories, for safe transport. Not for use in Ex-zone	0516 0117
Holder with lock for data logger, theft-proof	0554 1782
Stainless steel sintered cap, Ø 21 mm, can be screwed onto humidity probe, protection in case of high mechanical load and high velocities	0554 0640
<b>Additional accessories and spare parts</b>	
testo saline pots for control and humidity adjustment of humidity probes, 11.3 %RH and 75.3 %RH with adapter for humidity probe, quick checks or calibration of humidity probe (not for use in Ex zone)	0554 0660
<b>Software and Accessories</b>	
ComSoft 3 - Professional with data management, incl. database, analysis and graphics function, data analysis, trend curve (not for use in Ex zone)	0554 0830
ComSoft 3 - For requirements to CFR 21 Part 11, incl. database, analysis and graphics function, data analysis, trend curve (w/o interface) (not for use in Ex zone)	0554 0821
Interface, attachable to testostor 171 data logger (not for use in Ex zone)	0554 1781
Ethernet adapter, RS232 - Ethernet incl. software driver, mains unit, facilitates data communication in network (not for use in Ex zone)	0554 1711
<b>Calibration Certificates</b>	
ISO calibration certificate humidity, calibration points 11.3 %RH and 75.3 %RH at +25 °C/+77 °F; per channel/instrument	0520 0076
DKD calibration cert./humidity, humidity data logger; cal. points 11.3%RH and 75.3%RH at +25°C; per channel/instrument	0520 0246
ISO calibration certificate/temperature, temperature probe; calibration points -18°C; 0°C; +60°C per channel/instrument	0520 0151
ISO calibration certificate/temperature, temp. data logger; calibration points -8°C; 0°C; +40°C per channel/instrument	0520 0171
DKD calibration certificate/temperature, Temperature probe; cal. points -20°C; 0°C; +60°C (-4 °F, 92 °F, 140 °F); per channel/instrument	0520 0261

Recommended Set
<b>Ex 171-3, The Set in the Case</b>
- Ex 171-3, humidity data logger %RH, °C, incl. starting magnet, battery and calibration protocol; calibration certificates (ISO/DKD) must be ordered separately (Part no. 0577 1733)
- ComSoft 3 - Professional with data management (Part no. 0554 0830)
- Interface, attachable to testostor 171 data logger (Part no. 0554 1781)
- Transport case (plastic) for measurement data storage instruments (max. 6 off) and accessories (Part no. 0516 0117)

Technical data		
<b>Probe type</b>	<b>NTC</b>	<b>Testo humid. sensor, cap.</b>
Meas. range	-10 to +50 °C	0 to +100 %RH
Accuracy ±1 digit	±0.4 °C (-10 to +50 °C)	±2 %RH (+2 to +98 %RH)
Resolution	0.1 °C	0.1 %RH
Oper. temp.	-10 to +50 °C	Protection class IP65
Storage temp.	-40 to +85 °C	Warranty 2 years
Memory	20000	Battery life: Lithium battery up to 5 years
Material/Housing	Aluminium, anodized	Software: Menu-driven Microsoft Windows 95 / ME / 2000 / XP / Vista
Battery type	Lithium battery	
Dimensions	131 x 72 x 68 mm	
Weight	320 g	

## testostor 171-2

## Internal humidity/temperature sensor with dew point calculation

testostor 171-2 is a compact, accurate data logger with an internal probe, parallel dew point measurement and large memory capacity.

- Control and adjustment possible using adjustment set
  - Sintered cap protection for dusty areas
  - Large memory for up to 55,000 readings
  - Protection class IP65
- With calibration protocol (optional)



testostor 171-2, humidity logger for %RH, °C, td, incl. starting magnet, battery and calibration protocol; calibration certificates (ISO/DKD) must be ordered separately

Part no.  
**0577 1712**



Accessories	Part no.
-------------	----------

Transport and Protection	
--------------------------	--

Transport case (plastic) for measurement data storage instruments (max. 6 off) and accessories, for safe transport	0516 0117
--	-----------

Holder with lock for data logger, theft-proof	0554 1782
---	-----------

Stainless steel sintered cap, Ø 21 mm, can be screwed onto humidity probe, protection in case of high mechanical load and high velocities 0554 0640

Additional Accessories and Spare Parts	
--	--

Spare battery for testostor 171, quick and easy battery replacement	0515 0018
---	-----------

testo saline pots for control and humidity adjustment of humidity probes, 11.3 %RH and 75.3 %RH with adapter for humidity probe, quick checks or calibration of humidity probe	0554 0660
--	-----------

Software and Accessories	
--------------------------	--

ComSoft 3 - Professional with data management, incl. database, analysis and graphics function, data analysis, trend curve	0554 0830
---	-----------

ComSoft 3 - For requirements to CFR 21 Part 11, incl. database, analysis and graphics function, data analysis, trend curve (w/o interface)	0554 0821
--	-----------

Interface, attachable to testostor 171 data logger	0554 1781
--	-----------

Ethernet adapter, RS232 - Ethernet incl. software driver, mains unit, facilitates data communication in network	0554 1711
---	-----------

Calibration Certificates	
--------------------------	--

ISO calibration certificate/temperature, temp. data logger; calibration points -8°C; 0°C; +40°C per channel/instrument	0520 0171
--	-----------

DKD calibration cert./humidity, humidity data logger; cal. points 11.3%RH and 75.3%RH at +25°C; per channel/instrument	0520 0246
--	-----------

ISO calibration certificate humidity, calibration points 11.3 %RH and 75.3 %RH at +25 °C/+77 °F; per channel/instrument	0520 0076
---	-----------

Technical data			
----------------	--	--	--

Probe type	NTC	Testo humid. sensor, cap.	Calc. parameter
------------	-----	---------------------------	-----------------

Meas. range	-20 to +70 °C	0 to +100 %RH	-20 to +70 °C td
-------------	---------------	---------------	------------------

Accuracy ±1 digit	±0.4 °C (-10 to +50 °C) ±0.5 °C (-20 to -10.1 °C) ±0.5 °C (+50.1 to +70 °C)	±2 %RH (+2 to +98 %RH)	
----------------------	---	------------------------	--

Resolution	0.1 °C	0.1 %RH	
------------	--------	---------	--

Oper. temp.	-20 to +70 °C	Protection class	IP65
-------------	---------------	------------------	------

Storage temp.	-40 to +85 °C	Warranty	2 years
---------------	---------------	----------	---------

Memory	55000	Measuring cycle: 2s to 24h selectable	
--------	-------	---------------------------------------	--

Material/Housing	Aluminium, anodized	Battery life: up to 5 years	
------------------	---------------------	-----------------------------	--

Battery type	Lithium battery (2032)	Software: Menu-driven from Microsoft	
--------------	------------------------	--------------------------------------	--

Dimensions	131 x 68 x 84 mm	Windows 95 / NT 4 Service pack 4 / ME /	
------------	------------------	---	--

Weight	320 g	2000 / XP / Vista	
--------	-------	-------------------	--



## testostor 171-6

The testostor 171-6 data logger has 2 probe sockets. Example: 2 separate multi-function %RH/°C probes for simultaneous checks on room and ambient humidity.

The Testo humidity sensor is PTB approved and guarantees a constant high measuring accuracy over a wide temperature range. Analysis of the humidity data can be expressed in %RH, dewpoint, g/m<sup>3</sup> water level.

testostor 171-6, humidity data logger for %RH, °C, td, incl. starting magnet, battery and calibration protocol; calibration certificates (ISO/DKD) must be ordered separately

Part no.  
**0577 1716**

## 2 external humidity/temperature probe sockets or dewpoint calculation

- Wide range of probes
- Probes can be positioned quickly and easily
- Data analysis via PC
- Large memory for 55,000 readings



### Humidity/temperature probes

Humidity/temperature probe with standard plastic protection cap



Cable/length 3 m

### Meas. range

0 to +100 %RH  
-20 to +70 °C

### Accuracy

±2 %RH (+2 to +98 %RH)

±0.4 °C (-10 to +50 °C)  
±0.5 °C (remaining range)

### t90

12 s

Part no.  
0636 9717

Mini humidity/temperature module for measurements at inaccessible points, module cable 1.5m long, probe tip 49x18x7 mm



Cable/length 1.5 m

0 to +100 %RH  
-20 to +120 °C

±2 %RH (+2 to +98 %RH)

±0.5 °C (-20 to +120 °C)

20 s

Part no.  
0628 0008

### Temperature probes (NTC)

Robust immersion/air probe, quick-action, 6m cable, IP68 probe tip



Conn.: Fixed cable 6 m

### Meas. range

-50 to +80 °C

### Accuracy

±0.2 °C (-25 to +80 °C)  
±0.4 °C (-50 to -25.1 °C)

### Reaction time

5 s  
t<sub>99</sub> (in water)

Part no.  
0610 1720

Air probe, highly accurate, can be attached directly



Conn.: Fixed cable 6 m

### Meas. range

-35 to +70 °C

### Accuracy

±0.2 °C (-35 to +70 °C)

180 s  
t<sub>90</sub>

Part no.  
0610 1722

Robust, accurate, waterproof food probe (IP65), made of stainless steel



Conn.: Fixed cable 2 m

### Meas. range

-50 to +120 °C

### Accuracy

±0.2 °C (-25 to +80 °C)  
±0.4 °C (-50 to -25.1 °C)  
±0.5 °C (+80.1 to +120 °C)

10 s  
t<sub>99</sub> (in water)

Part no.  
0610 2217

Pipe probe with Velcro, measures flow/return temperature, pipe diameter max. 80 mm



Conn.: Fixed cable 3 m

### Meas. range

-50 to +80 °C

### Accuracy

±0.2 °C (-25 to +80 °C)  
±0.4 °C (-50 to -25.1 °C)

Part no.  
0610 4617

Wall surface temperature probe, e.g. provides proof of damage to building material, cable 6.1 m long, probe tip 40x15x0.2 mm



Conn.: Fixed cable 6 m

### Meas. range

-50 to +120 °C

### Accuracy

±0.5 °C (-50 to +120 °C)

20 s  
t<sub>90</sub>

Part no.  
0628 0007



**testostor 171-6**
**Accessories / Technical data**

Accessories		Part no.	Technical data			
<b>Transport and Protection</b>			<b>Probe type</b>	<b>NTC</b>	<b>Testo humid. sensor, cap.</b>	<b>Calc. parameter</b>
Transport case (plastic) for measurement data storage instruments (max. 6 off) and accessories, for safe transport		0516 0117	Meas. range	-50 to +120 °C	0 to +100 %RH	-30 to +50 °C td
Holder with lock for data logger, theft-proof		0554 1782	Accuracy ±1 digit	±0.4 °C (-10 to +50 °C) ±0.6 °C (-50 to -10.1 °C) ±0.6 °C (+50.1 to +120 °C)	±2 %RH (+2 to +98 %RH)	
Stainless steel sintered cap, Ø 12 mm, is screwed onto humidity probe, for measurements at higher flow velocities or in contaminated air		0554 0647	Resolution	0.1 °C	0.1 %RH	
Sintered PTFE filter, Ø 12 mm, for corrosive media, High humidity range (long-term measurements), high flow velocities.		0554 0756				
<b>Additional Accessories and Spare Parts</b>			Oper. temp.	-20 to +70 °C	Dimensions	131 x 68 x 26 mm
Spare battery for testostor 171, quick and easy battery replacement		0515 0018	Storage temp.	-40 to +85 °C	Warranty	2 years
testo saline pots for control and humidity adjustment of humidity probes, 11.3 %RH and 75.3 %RH with adapter for humidity probe, quick checks or calibration of humidity probe		0554 0660	Battery type	Lithium battery (2032)	Meas. cycle: 2s to 24h freely selectable	
<b>Software and Accessories</b>			Protection class	IP65	Software: menu-driven from Microsoft Windows 95 / ME / 2000 / XP / Vista	
ComSoft 3 - Professional with data management, incl. database, analysis and graphics function, data analysis, trend curve		0554 0830	Memory	55000	Battery life: 5 years	
ComSoft 3 - For requirements to CFR 21 Part 11, incl. database, analysis and graphics function, data analysis, trend curve (w/o interface)		0554 0821	Weight	305 g		
Interface, attachable to testostor 171 data logger		0554 1781				
Ethernet adapter, RS232 - Ethernet incl. software driver, mains unit, facilitates data communication in network		0554 1711				
<b>Calibration Certificates</b>						
ISO calibration certificate/temperature, temp. data logger; calibration points -8°C; 0°C; +40°C per channel/instrument		0520 0171				
ISO calibration certificate humidity, Calibration points 11.3 %RH and 75.3 %RH at +25°C		0520 0006				
ISO calibration certificate humidity, calibration points 11.3 %RH and 75.3 %RH at +25 °C/+77 °F; per channel/instrument		0520 0076				
DKD calibration certificate/humidity, electronic hygrometers; calibration points 11.3%RH and 75.3%RH at +25°C		0520 0206				
DKD calibration cert./humidity, humidity data logger; cal. points 11.3%RH and 75.3%RH at +25°C; per channel/instrument		0520 0246				

## testo 575

## Fast-action printer and logger control in one for testo 175/177

testo 575 is the practical fast-action printer for all testo 175 and 177 data loggers. It can be set to your language. In addition to being a practical printer, testo 575 can also be used as a logger control unit.

Fast testo 575 printer, incl. 1 roll of thermal paper and batteries

Part no.  
**0554 1775**

### Print functions

- Fast-action print mechanism, 6 lines/s
- Prints tables/graphics
- Brief info. or full memory can be printed as required
- Determine section to be printed
- Your language can be set
- Self-adhesive Testo paper can also be used

### Control functions

- Stops testo 175/177 loggers
- Reboots logger with saved parameters (reprogramming)
- Both buttons can be blocked by PC software



### Technical data

Printer: Infrared thermal line printer with graphics function  
 Contrast: Can be adjusted  
 Paper width: 56 mm  
 Roll diameter: Up to 35 mm  
 Paper: Standard paper and two-layer adhesive  
 Number of characters per line: 24  
 Graphics resolution: 203 dpi  
 Operating temp.: -5 to +50°C (for 5 min at -

30°C)  
 Storage temperature: -30 to +70°C  
 Power: 6x round cell 1AA  
 Battery life: Up to 40,000 print lines  
 Battery change: By user  
 Housing: ABS (black), with "Soft-Protect" inserts

### Accessories

Spare thermal paper for printer (6 rolls)

### Part no.

0554 0569

Spare thermal paper for printer (6 rolls), measurement data documentation legible for up to 10 years

0554 0568

Label thermal paper (Testo patent) for testo 575 printer (6 rolls), can be applied directly

0554 0561



**testo 580**

**Compact data collector for readout on site for testo 175/177**

The testo 580 data collector collects data on site for central upload to PC and analysis

**The readout function**

- Can read out up to 25 full testo 175 loggers or 10 full testo 177 loggers
- Displays all status information
- Download collected data to PC using Testo ComSoft 3



**Control functions**

- Stops logger
- Reboots logger
- Both control functions can be blocked via PC

testo 580 data collector set with RS232, readout holders included, for testo 175/177 data loggers

Part no.  
**0554 1778**

testo 580 data collector set with USB, readout holders included, for testo 175/177 data loggers

Part no.  
**0554 1764**

**Technical data**

Memory capacity: 1 MB (approx. 500,000 values)
Read out time in logger: Approx. 400 readings/s
Read out time in PC: Approx. 1,500 readings/s
Logger interface: Infrared transfer, bidirectional
PC interface: RS232 (Sub_D socket) or USB
Operating temperature: -30 to +70°C
Storage temperature: -40 to +85°C
On/Off switch: Off: AutoOFF to 1 min

**Functions**

Display: Logger memory used, testo 580 memory used, logger battery life, testo 580 battery life, data transfer in progress, data transfer ok or defective, wraparound display  
Other: Data secure even if battery is spent  
Power: 3x micro AAA cells  
Housing: ABS (black)

**testo 581**

**Alarm switching for forwarding alarm reports for testo 175/177**

The alarm signal output testo 581 makes it possible to send alarm messages to external components, e.g.: horns, lamps, PLC.

**Alarm is triggered when:**

- Programmed limit values in the data logger are exceeded
- Logger is stopped due to spent battery
- Probe is disconnected
- Alarm unit battery is spent

External components are connected via a terminal strip in the battery compartment of testo 581, the signal is transferred via the floating signal output. This can be set as an NC or NO contact.

**The control functions**

You will be informed directly at the touch of a button, if the alarm has already been triggered. The alarm of the external components, e.g. the horn, can be reset using the reset button.



testo 581 alarm signal output, floating, for testo 175/177

Part no.  
**0554 1769**

**Technical data**

Signal	Floating signal output, can be set as NC or NO contact
No./switch. chann.	1 channel
Power limit signal output	Battery (Included) or 9 to 32V DC max. (external)
Max. switching voltage	60V DC/25V AC (SELV/PELV switch circuits)
Max. duration switch-off current	1A DC/AC
Max. switch power	30W/30VA
Conn.	Via terminal strip in battery compartment (output and power)
Oper. temp.	-40 to +70 °C
Storage temp.	-40 to +85 °C
Battery type	Lithium (1/2 AA)
Battery life	Approx. 5 years
Material/Housing	Polycarbonate (black)
Dimensions	82 x 52 x 30 mm
Protection class	IP68

**Connection assignment (back of limit signal output)**

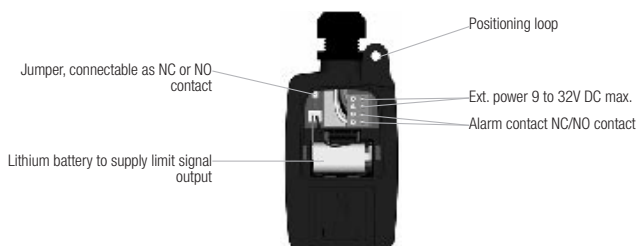

testo 581 can be used together with all testo 175/177 data loggers. Once connected to the data logger wall holder, communication between testo 175/177 and the limit signal output takes place via the infrared interface.

## ComSoft 4 - Basic

The Basic version has all the functions needed to monitor, analyse, save and print data. The limit values to be monitored can be defined as required; short titles, text fields and channel names ensure clear allocation if several loggers are in use.

Once read out, the data can be shown in table or line graphics and then analysed.

The e-mail address of the desired recipient can be entered when programming so that data can be easily forwarded through your locally installed e-mail program by simply clicking on "Send...". The saved e-mail address is then entered in the address box.

## Easy operation and convenient analysis for testo 175/177

### Additional functions:

- Axes can be scaled as required
- Frequently used scales can be saved for future use
- Printout as table or graphic on all printers compatible with Windows
- Data export to other applications via clipboard
- Crosshair function, fast scanning in graphics with direct value display
- Min/Max and mean calculation



Programming the logger

### Comsoft 4 - Basic for:

- Data loggers from the testo 175 and testo 177 series

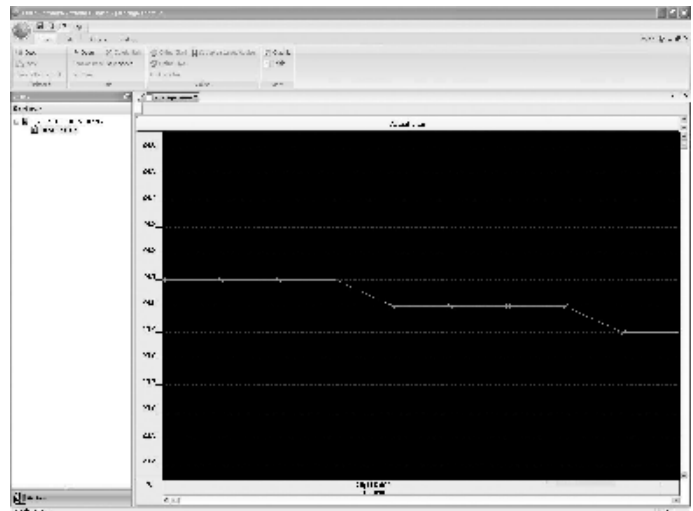

Analysing measurement data

Table view/Documentation

### testo 175

#### ComSoft 4 Set - Basic with RS232 interface

Basic software with diagram and table function, incl. desk-top holder, PC connection cable

Part no.

**0554 1759**

#### ComSoft 4 - Basic Set with USB interface for testo 175

Basic software with diagram and table function, incl. desk-top holders, PC connection cable

Part no.

**0554 1766**

### testo 177

#### ComSoft 4 Set - Basic with RS 232 interface for testo 177

Basic software with diagram and table function, incl. desk-top holder, PC connection cable

Part no.

**0554 1774**

#### ComSoft 4 - Basic Set with USB interface for testo 177

Basic software with diagram and table function, incl. desk-top holders, PC connection cable

Part no.

**0554 1767**

Accessories	Part no.
RS232 interface for testo 175/177 incl. desk-top holders, PC connection cable, (please also order for ComSoft 3 - Professional)	0554 1757
USB interface, for testo 175/177 incl. desk-top holders, PC conn. cable, (Please order with ComSoft 3 - Professional)	0554 1768
Interface, attachable to testostor 171 data logger	0554 1781

## ComSoft 3 - Professional

In addition to all the functions of the Basic version, the Professional also has extra display options (e.g. digit box, bar chart, analog instrument, xy plot) and convenient data filing. Measurement data can be stored in their own folders so that, for example, several data loggers from different locations can be organised in a tree structure. It is particularly recommended for instruments, which can manage many measurement logs e.g. the testo 580 data collector. The driver in this instrument is set up such that the directory structure of the Professional software is supported. The result is clear and comprehensible data handling.

### ComSoft 3 - Professional with data management

incl. database, analysis and graphics function, data analysis, trend curve

Part no.  
**0554 0830**

## Pro software incl. data archiving for testo 175/177/171/645/650

### Additional functions:

- Adapt menus and range of functions
- Select different print heads when printing tables and graphics
- Extended display options such as digit box, bar chart, analog instrument and xy plot
- Input of mathematical functions with calculation on a new measurement channel
- Compensation functions 0 (mean) to 7th degree
- Developer ToolBox with functions for integrating the instrument driver in non-Testo software

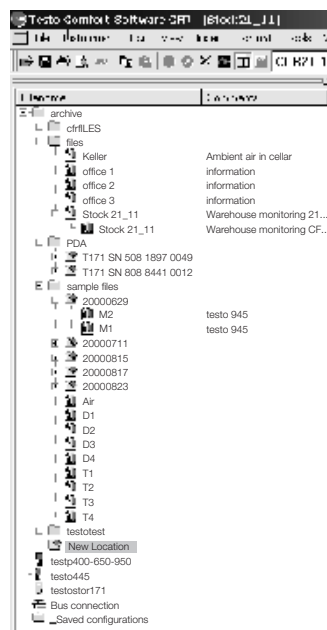

Structured filing of measured data and parameters in folders, locations, logs and channels

### Comsoft 3 -Professional for:

- Data loggers from the testo 175, testo 177 and testostor 171 series
- testo 645 monitoring instruments
- testo 650 reference measuring instruments

Accessories	Part no.
RS232 interface for testo 175/177 incl. desk-top holders, PC connection cable, (please also order for ComSoft 3 - Professional)	0554 1757
USB interface, for testo 175/177 incl. desk-top holders, PC conn. cable, (Please order with ComSoft 3 - Professional)	0554 1768
Interface, attachable to testostor 171 data logger	0554 1781

## CFR 21 Part 11

A validation-compatible ComSoft 3.3 Version 21 CFR 11 has been developed especially for the management and filing of process data. FDA requirements can be fulfilled if used as part of a closed system:

ComSoft 3 - For requirements to CFR 21 Part 11  
incl. database, analysis and graphics function, data analysis, trend curve (w/o interface)

Part no.  
**0554 0821**

## Software for CFR 21 Part 11 requirements for testo 175/177/171

- Identification of damaged or modified raw data
- Recognition of transfer errors using proof totals
- Inactivity lockout to prevent unauthorised access
- Monitors logins and logouts, successful/failed use of digital signatures and modification of raw data with the aid of Audit Trail
- Complete integration in the Windows 2000 security system (certificates, rights management, user and password management, user authentication)
- Option of data export in generally readable PDF file format e.g. to send to the FDA validation point responsible or to display during a company audit.

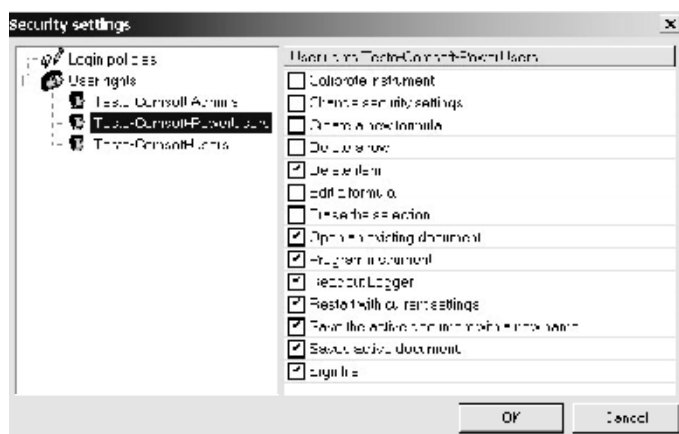

User management in groups

Time	Value	Limit	Status
2003-01-01 10:00:00	10.5	10.0	Violation
2003-01-01 10:05:00	11.2	10.0	Violation
2003-01-01 10:10:00	9.8	10.0	Violation
2003-01-01 10:15:00	10.1	10.0	Violation
2003-01-01 10:20:00	10.3	10.0	Violation
2003-01-01 10:25:00	10.4	10.0	Violation
2003-01-01 10:30:00	10.2	10.0	Violation
2003-01-01 10:35:00	10.1	10.0	Violation
2003-01-01 10:40:00	10.0	10.0	OK
2003-01-01 10:45:00	10.1	10.0	Violation
2003-01-01 10:50:00	10.2	10.0	Violation
2003-01-01 10:55:00	10.3	10.0	Violation
2003-01-01 11:00:00	10.4	10.0	Violation
2003-01-01 11:05:00	10.5	10.0	Violation
2003-01-01 11:10:00	10.6	10.0	Violation
2003-01-01 11:15:00	10.7	10.0	Violation
2003-01-01 11:20:00	10.8	10.0	Violation
2003-01-01 11:25:00	10.9	10.0	Violation
2003-01-01 11:30:00	11.0	10.0	Violation

Display: Limit value violation in table format



Graphic display of readings



- User management in User Groups by Administrator (using Windows 2000 Rights management and three additional ComSoft-specific user groups)
- Save raw data in tamper-proof file format

## Ethernet adapter

## With testo measuring instruments in Ethernet

### The new Ethernet adapter facilitates:

- Measurements on site, e.g. production, warehouses, incoming goods
- Measuring instrument remains on site, transport not necessary
- Data can be checked from office
- Centralised data filing

### Ethernet offers:

- Fast transfer of readings
- Use of an existing network without additional cabling
- Long transmission paths
- Identification of measuring instruments in system network

### Long-term monitoring of climate data

The parameters temperature and humidity are logged and saved on site by the data logger. Using the Ethernet adapter, the measurement data saved in the logger can be read out and filed via the PC network. The data is easily analysed and checked on the PC in your office.

The Ethernet adapter has the following benefits:

- Affordable handling since it is not necessary to read the data on location or to take the logger into the office
- Short access times because you can quickly access the current measurement data at any time.



**Ethernet adapter, RS232 - Ethernet incl. software driver, mains unit facilitates data communication in network (not for use in Ex-zone)**

Part no.  
**0554 1711**



### Multi-point checks on site

Spot checks are carried out on site in production halls or in incoming goods departments using Testo handheld measuring instruments. The measurement data can be sent immediately to a central office via the Ethernet adapter. This facilitates fast reaction times if further actions are required.

Accessories	Part no.
<b>System accessories: testo 650</b>	
ComSoft 3 - Professional with data management, incl. database, analysis and graphics function, data analysis, trend curve	0554 0830
RS232 cable, connects instrument to PC (1.8 m) for data transfer	0409 0178
<b>System accessories: testo 175, testo 177</b>	
ComSoft 3 - Professional with data management, incl. database, analysis and graphics function, data analysis, trend curve	0554 0830
RS232 interface for testo 175/177 incl. desk-top holders, PC connection cable, (please also order for ComSoft 3 - Professional)	0554 1757
<b>System accessories: testo 171</b>	
ComSoft 3 - Professional with data management, incl. database, analysis and graphics function, data analysis, trend curve	0554 0830
Interface, attachable to testostor 171 data logger	0554 1781

Technical data		Management and software config.	Internet Browser e.g. from Netscape or Microsoft Telnet
Dimensions	45 x 48 x 14 mm	Interface	Serial interface on computer board with terminal program
Oper. temp.	+0 to +70 °C		
Software	Microsoft Windows 2000 / NT 4.0 / ME / 98 / 95		
Power supply	Mains unit, 5 Volt app. 230 mA	Provision of a local virtual COM port (Windows systems)	
Humidity class	F to DIN 40040		
EMC	Radio interference/Fault free op.		
Interface	25 pin RS 232 connection with adapter 25/9pin		
Logs	TCP/IP, LPR, Telnet, SNMP, DHCP DDNS, ARP, BOOTP, ICMP		



## testo 645

## Industrial thermohygrometer

The testo 645 humidity measuring instrument automatically displays the parameters relative humidity, absolute humidity, dew point, degree of humidity, enthalpy and temperature.

Convenient data analysis on your PC with location name.

A wide range of humidity and temperature probes suitable for high temperature measurement to monitoring humidity in compressed air systems are available.

- Highly accurate humidity meas. to  $\pm 1\%RH$
- Internal data memory
- Convenient data analysis
- TopSafe for tough applications



- Channel 1: temperature probe type K/J/S, NTC
- Channel 2: Combined humidity/temperature probe or Pt100 temperature probe
- Mains connection and battery recharging in instrument
- 4 line display
- Displays two parameters
- Printing at the touch of a button
- Saves up to 3000 readings
- Selects up to 99 sites
- Easy operation with cursor
- HOLD/MAX values/MIN values/Mean calculation

testo 645, humidity/temperature measuring instrument, with TopSafe, battery and calibration protocol

Part no.  
**0563 6450**

Probes	Illustration	Meas. range	Accuracy	t90	Part no.
Standard ambient air probe up to +70°C	$\varnothing 12\text{ mm}$ Plug-in head, connection cable 0430 0143 or 0430 0145 required	0 to +100 %RH -20 to +70 °C	$\pm 2\%RH$ (+2 to +98 %RH) $\pm 0.4\text{ °C}$ (-10 to +50 °C) $\pm 0.5\text{ °C}$ (remaining range)	12 s	0636 9740
Duct humidity/temperature probe, can be connected to telescopic handle 0430 9715	180 mm $\varnothing 12\text{ mm}$ Fixed cable 3 m	0 to +100 %RH -20 to +70 °C	$\pm 2\%RH$ (+2 to +98 %RH) $\pm 0.4\text{ °C}$ (-10 to +50 °C) $\pm 0.5\text{ °C}$ (remaining range)	12 s	0636 9715
Thin humidity probe incl. 4 attachable protection caps for ambient air measurements, measurements in exhaust air ducts and equilibrium moisture measurements	250 mm $\varnothing 4\text{ mm}$ Plug-in head, connection cable 0430 0143 or 0430 0145 required	0 to +100 %RH -20 to +70 °C	$\pm 2\%RH$ (+2 to +98 %RH) $\pm 0.4\text{ °C}$ (-10 to +50 °C) $\pm 0.5\text{ °C}$ (-20 to -10.1 °C) $\pm 0.5\text{ °C}$ (+50.1 to +70 °C)	15 s	0636 2130
Highly accurate reference humidity/temp. probe	$\varnothing 21\text{ mm}$ Plug-in head, connection cable 0430 0143 or 0430 0145 required	0 to +100 %RH -20 to +70 °C	$\pm 1\%RH$ (+10 to +90 %RH)* $\pm 2\%RH$ (remaining range) $\pm 0.2\text{ °C}$ (+10 to +40 °C) $\pm 0.4\text{ °C}$ (remaining range)	12 s	0636 9741
Flexible humidity probe with mini module for meas. e.g. on material testing rigs, module cable length 1500mm, probe tip 50x19x7mm	1500 mm Plug-in head, connection cable 0430 0143 or 0430 0145 required	0 to +100 %RH -20 to +125 °C	$\pm 2\%RH$ (+2 to +98 %RH) $\pm 0.4\text{ °C}$ (-10 to +50 °C) $\pm 0.5\text{ °C}$ (remaining range)	20 s	0628 0013
Sword probe for measuring humidity and temperature in stacked material	320 mm 18 mm x 5 mm Plug-in head, connection cable 0430 0143 or 0430 0145 required	0 to +100 %RH -20 to +70 °C	$\pm 2\%RH$ (+2 to +98 %RH) $\pm 0.4\text{ °C}$ (-10 to +50 °C) $\pm 0.5\text{ °C}$ (-20 to -10.1 °C) $\pm 0.5\text{ °C}$ (+50.1 to +70 °C)	12 s	0636 0340
High humidity level probe w/ heated sensor element, no humidity on sensor	300 mm $\varnothing 12\text{ mm}$ Plug-in head, connection cable 0430 0143 or 0430 0145 required	0 to +100 %RH -20 to +85 °C	$\pm 2.5\%RH$ (0 to +100 %RH) $\pm 0.4\text{ °C}$ (-10 to +50 °C) $\pm 0.5\text{ °C}$ (-20 to -10.1 °C) $\pm 0.5\text{ °C}$ (+50.1 to +100 °C)	30 s	0636 2142
Robust high temperature/humidity probe up to +180°C	300 mm $\varnothing 12\text{ mm}$ Plug-in head, connection cable 0430 0143 or 0430 0145 required	0 to +100 %RH -20 to +180 °C	$\pm 2\%RH$ (+2 to +98 %RH) $\pm 0.4\text{ °C}$ (+0.1 to +50 °C) $\pm 0.5\text{ °C}$ (remaining range)	30 s	0628 0021
Flexible humidity probe (does not retain shape) for measurements in inaccessible places	1500 mm $\varnothing 12\text{ mm}$ Plug-in head, connection cable 0430 0143 or 0430 0145 required	0 to +100 %RH -20 to +180 °C	$\pm 2\%RH$ (+2 to +98 %RH) $\pm 0.4\text{ °C}$ (+0.1 to +50 °C) $\pm 0.5\text{ °C}$ (-20 to 0 °C) $\pm 0.5\text{ °C}$ (+50.1 to +180 °C)	30 s	0628 0022
Standard pressure dew point probe for measurements in compressed air systems	300 mm Plug-in head, connection cable 0430 0143 or 0430 0145 required	0 to +100 %RH -30 to +50 °C tpd	$\pm 0.9\text{ °C tpd}$ (+0.1 to +50 °C tpd) $\pm 1\text{ °C tpd}$ (-4.9 to 0 °C tpd) $\pm 2\text{ °C tpd}$ (-9.9 to -5 °C tpd) $\pm 3\text{ °C tpd}$ (-19.9 to -10 °C tpd) $\pm 4\text{ °C tpd}$ (-30 to -20 °C tpd)	300 s	0636 9840
Precision pressure dew point probe for measurements in compressed air systems incl. cert. with test point -40°C tpd	300 mm Plug-in head, connection cable 0430 0143 or 0430 0145 required	0 to +100 %RH -60 to +50 °C tpd	$\pm 0.8\text{ °C tpd}$ (-4.9 to +50 °C tpd) $\pm 1\text{ °C tpd}$ (-9.9 to -5 °C tpd) $\pm 2\text{ °C tpd}$ (-19.9 to -10 °C tpd) $\pm 3\text{ °C tpd}$ (-29.9 to -20 °C tpd) $\pm 4\text{ °C tpd}$ (-40 to -30 °C tpd)	300 s	0636 9841
Flexible humidity probe (retains shape) for measurements at inaccessible points	450 mm $\varnothing 14\text{ mm}$ Plug-in head, connection cable 0430 0143 or 0430 0145 required	0 to +100 %RH -20 to +125 °C	$\pm 2\%RH$ (+2 to +98 %RH) $\pm 0.4\text{ °C}$ (-10 to +50 °C) $\pm 0.5\text{ °C}$ (-20 to -10.1 °C) $\pm 0.5\text{ °C}$ (+50.1 to +125 °C)	30 s	0628 0014

Caps for humidity probes, see Ordering data for Accessories

The measuring instrument inside TopSafe is waterproof with this probe.

\* in the temperature range from +10°C to +30°C

See testo 650 for more probes



**testo 645**
**Sets, practical accessories and technical data**

Accessories	Part no.
<b>Transport and Protection</b>	
Transport case (plastic) for measuring instrument, probes and accessories now larger for safe and orderly storage	0516 0445
<b>Additional Accessories and Spare Parts</b>	
Desk-top power supply with international connection options	0554 1143
9V rech. battery for instrument instead of battery	0515 0025
Cable, 1.5 m long, connects probe with plug-in head to meas. instrument PUR coating material	0430 0143
Extension cable, 5 m long, between plug-in head cable and instrument PUR coating material	0409 0063
Telescopic handle, 340 - 800 mm long, for 0636 9715 probe	0430 9715
Adapter for surface humidity measurement, for humidity probes Ø 12mm locates damp spots on walls, for example	0628 0012
Cap for bore holes, for humidity probe Ø 12 mm Measures equilibrium moisture in bore holes	0554 2140
testo saline pots for control and humidity adjustment of humidity probes, 11.3 %RH and 75.3 %RH with adapter for humidity probe	0554 0660
Sintered PTFE filter, Ø 12 mm, for corrosive media High humidity range (long-term measurements), high flow velocities.	0554 0756
Stainless steel sintered cap, Ø 12 mm, is screwed onto humidity probe for measurements at higher flow velocities or in contaminated air	0554 0647
<b>Printers and Accessories</b>	
Testo fast printer with wireless infrared interface, 1 roll thermal paper and 4 AA batteries	0554 0549
Fast testo 575 printer, incl. 1 roll of thermal paper and batteries infrared thermal line printer with graphics function	0554 1775
External fast charger for 1-4 AA rech. batteries, incl. 4 Ni-MH rech. batteries with individual cell charging and charge control display, incl. impulse trickle charging, integrated discharge function, with built-in international mains plug, 100-240 V, 300 mA, 50/60 Hz	0554 0610
Spare thermal paper for printer (6 rolls)	0554 0569
Spare thermal paper for printer (6 rolls) measurement data documentation legible for up to 10 years	0554 0568
Label thermal paper (Testo patent) for testo 575 printer (6 rolls), can be applied directly	0554 0561
<b>Software and Accessories</b>	
ComSoft 3 - Professional with data management incl. database, analysis and graphics function, data analysis, trend curve	0554 0830
RS232 cable connects instrument to PC (1.8 m) for data transfer	0409 0178
<b>Calibration Certificates</b>	
ISO calibration certificate humidity Calibration points 11.3 %RH and 75.3 %RH at +25°C	0520 0006
DKD calibration certificate/humidity electronic hygrometers; calibration points 11.3%RH and 75.3%RH at +25°C	0520 0206

Technical data		Pt100	Type K (NiCr-Ni)
Probe type			
Meas. range	0 to +100 %RH	-200 to +800 °C	-200 to +1370 °C
Accuracy ±1 digit	See probe data	±0.1% of mv (+200.1 to +800 °C) ±0.2 °C (-200 to +200 °C)	±0.5% of mv (+60 to +1370 °C) ±0.3 °C (-200 to +59.9 °C)
Resolution	0.1 %RH (0 to +100 %RH)	0.1 °C (-200 to +800 °C)	0.1 °C (-200 to +1370 °C)

Probe type	Type S (Pt10Rh-Pt)	Type J (Fe-CuNi)	NTC
Meas. range	-50 to +1700 °C	-40 to +750 °C	-50 to +150 °C
Accuracy ±1 digit			
Resolution			0.1 °C (-50 to +150 °C)

Oper. temp.	0 to +50 °C
Storage temp.	-20 to +70 °C
Display	LCD, 4 lines
Battery type	Alkali manganese
Battery life	45 h
Dimensions	215 x 68 x 47 mm
Weight	255 g
Material/Housing	ABS
Warranty	2 years

Accuracy of temperature: ± 1 digit at +22°C  
Ni 10000 sensor: meas. range: ...+180°C  
Typical battery lives: 9V block (Al-Mn) 20-45h.  
The hour times are reduced by a factor of 5 if a 9V rech. battery is used  
Calculated humidity parameters: td, g/m<sup>3</sup>, g/kg, J/g (pressure compensated)  
Mains connection and battery recharging in instrument

## testo 650

Precision reference class measuring instruments have everything the professional user needs to complete complicated measurement tasks efficiently, accurately and conveniently.

testo 650 includes the basic parameters temperature, CO<sub>2</sub>, rpm, current and voltage. It is also possible to measure humidity and pressure using testo 650. testo 650 can be upgraded to the multi-function measuring instrument testo 400.

The measuring instrument can keep up with the measurement tasks at hand thanks to upgrades. Intelligent electronics ensure the latest technology is used thanks to software updates.

Upgradable and teachable, highly reliable and of the highest quality - they are the properties which guarantee that the customer is equipped for the future.

Useful instrument functions:

- All functions of testo 950
- Calculation of all parameters in the psychrometric chart:
- Relative humidity %RH, dewpoint and pressure dewpoint (td, tpd)
- Absolute humidity g/m<sup>3</sup>, psychrometric wet bulb temperature
- Degree of humidity (g/kg), partial pressure in water vapour in mbar/hPa
- Enthalpy kcal/kg
- aW value measurement with trend display
- Barometric air pressure

testo 650, reference humidity meas. instr., readings memory included (up to 500,000 readings), battery, Li cell and calibration protocol

Part no.  
**0563 6501**

## Reference humidity measuring instrument with psychrometric chart and aw value measurement

- integrated reading memory up to 500,000 readings
- Special advantage: automatic correction of absolute pressure for accurate measurements. aw value measurement with trend display and automatic recognition of equilibrium.
- Clear graphics display
- 3 user defined function buttons
- Saves or prints at the touch of a button
- Mains connection/fast recharging
- Attachable printer (optional) Print readings in seconds on site
- Data communication by PC
- Barcode pen (optional)
- User-friendly operation with cursor via menu structure
- 2 user defined probe sockets, automatic recognition of all connected probes



Attachable printer  
Readings can be printed in seconds on site

Clear graphics display

Data communication with PC

3 user defined function buttons

Saves or prints at the touch of a button

Easy operation with cursor

Power connection/fast recharging

2 user-defined probe sockets

**testo 650**
**Recommended sets and accessories**

Accessories	Part no.	Calibration Certificates	Part no.
<b>Update from testo 650 to testo 400</b>		<b>Calibration certificates/temperature</b>	
Velocity module, incl. volume flow, degree of turbulence... upgrade via service (updates testo 650 to testo 400)	0450 4003	ISO calibration certificate/temperature for air/immersion probes, calibration points -18°C; 0°C; +60°C	0520 0001
<b>Accessories for measuring instrument</b>		ISO calibration certificate/temperature Meas. instr. with air/immersion probe; cal. points 0°C; +150°C; +300°C	0520 0021
Rech. batt. set for instr. (2 rech. 2.4V/1100mAh) selected for quick recharging in instrument	0554 0196	ISO calibration certificate/temperature meas. instr. with surface probe; calibration points +60°C; +120°C; +180°C	0520 0071
Mains unit 230 V/ 8 V/ 1 A, for instrument (European plug) for mains operation and battery recharging	0554 1084	DKD calibration certificate/temperature meas. instr. with air/immersion probe; calibration points -20°C; 0°C; +60°C	0520 0211
Lithium battery, button cell, type CR 2032, Spare Li cell to save RAM data, when changing battery and rech. battery	0515 0028	DKD calibration certificate/temperature contact surface temperature probes; calibration points +100°C; +200°C; +300°C	0520 0271
<b>Printer and Accessories</b>		<b>Calibration certificates/humidity</b>	
Attachable printer (securely attached) including 1 roll of thermal paper and batteries	0554 0570	ISO calibration certificate/humidity cal. points freely selectable from 5 to 95%RH at +15 to +35°C or at -18 to +80°C	0520 0106
Testo fast printer with wireless infrared interface, 1 roll thermal paper and 4 AA batteries	0554 0549	ISO calibration certificate humidity Calibration points 11.3 %RH and 75.3 %RH at +25°C	0520 0006
Fast testo 575 printer, incl. 1 roll of thermal paper and batteries	0554 1775	ISO calibration certificate dewpoint two adjustment points -10/-40 °Ctd at 6 bar	0520 0136
Infrared thermal line printer with graphics function	0554 1775	ISO calibration certificate/humidity saturated saline solutions: calibration point 11.3%RH	0520 0013
External fast charger for 1-4 AA rech. batteries, incl. 4 Ni-MH rech. batteries with individual cell charging and charge control display, incl. impulse trickle charging, integrated discharge function, with built-in international mains plug, 100-240 V, 300 mA, 50/60 Hz	0554 0610	ISO calibration certificate/humidity saturated saline solutions, calibration point 75.3%RH	0520 0083
Spare thermal paper for printer (6 rolls)	0554 0569	DKD calibration certificate/humidity electronic hygrometers; calibration points 11.3%RH and 75.3%RH at +25°C	0520 0206
Spare thermal paper for printer (6 rolls) measurement data documentation legible for up to 10 years	0554 0568	DKD calibration certificate/humidity cal. points freely selectable from 5 to 95%RH at +25°C or -18°C to +70°C	0520 0216
Label thermal paper (Testo patent) for testo 575 printer (6 rolls), can be applied directly	0554 0561	DKD calibration certificate/humidity saturated saline solutions; calibration point 11.3%RH	0520 0213
<b>SoftCase for instrument and printer</b>		DKD calibration certificate/humidity saturated saline solutions; calibration point 75.3%RH	0520 0283
SoftCase (protects instrument from impact) with carrier strap, magnetic holder and probe holder	0516 0401	<b>Calibration certificates/pressure</b>	
SoftCase for attachable printer (protects printer from dirt/impact) protects from impact and falls	0516 0411	ISO calibration certificate/pressure differential pressure, accuracy > 0.6 (% of full-scale value)	0520 0005
<b>Software and Accessories</b>		DKD calibration certificate/pressure differential pressure, accuracy > 0.6 (% of full-scale value)	0520 0225
ComSoft 3 - Professional with data management incl. database, analysis and graphics function, data analysis, trend curve	0554 0830	ISO calibration certificate/pressure differential pressure, accuracy 0.1 to 0.6 (% of fsv)	0520 0025
RS232 cable connects instrument to PC (1.8 m) for data transfer	0409 0178	DKD calibration certificate/pressure differential pressure, accuracy 0.1 to 0.6 (% of full-scale value)	0520 0215
Ethernet adapter, RS232 - Ethernet incl. software driver, mains unit facilitates data communication in network	0554 1711	ISO calibration certificate/absolute pressure, 5 measurement points distributed over meas. range absolute pressure, accuracy 0.1 to 0.6 (% of fsv)	0520 0125
<b>System case</b>		DKD calibration certificate/pressure absolute pressure, accuracy 0.1 to 0.6 (% of full-scale value)	0520 0212
System case (plastic) for measuring instrument, probes and accessories probes in lid make it easy to find parts in case (540 x 440 x 130 mm)	0516 0400		
System case (aluminium) for measuring instrument, probes and accessories probes in lid make it easy to find parts in case	0516 0410		

Technical data			
Probe type	Testo humid. sensor, cap.	Pressure	aw value
Meas. range	0 to +100 %RH	0 to +2000 hPa	0 to +1 aW
Accuracy ±1 digit	See probe data	Probe 0638 1347 Probe 0638 1447 Probe 0638 1547 Probe 0638 1647 Probe 0638 1747 Probe 0638 1847 ±0.1% of mv Probe 0638 1741 Probe 0638 1841 Probe 0638 1941 Probe 0638 2041 Probe 0638 2141 ±0.2% of mv	See probe data
Resolution	0.1 %RH (0 to +100 %RH)	0.001 hPa (probe 0638 1347) 0.001 hPa (probe 0638 1447) 0.01 hPa (probe 0638 1547) 0.1 hPa (probe 0638 1647) 0.1 hPa (probe 0638 1747) 0.1 hPa (probe 0638 1847) 0.01 bar (probe 0638 1741) 0.01 bar (probe 0638 1841) 0.01 bar (probe 0638 1941) 0.01 bar (probe 0638 2041) 0.01 bar (probe 0638 2141)	

Probe type	NTC	Pt100	
Meas. range	-40 to +150 °C	-200 to +800 °C	20 to 20000 rpm
Accuracy ±1 digit	±0.2 °C (-10 to +50 °C) ±0.4 °C (-40 to -10.1 °C) ±0.4 °C (+50.1 to +150 °C)	±0.1 °C (-49.9 to +99.9 °C) ±(0.1 °C + 0.1% of mv) remaining range	±1 digit
Resolution	0.1 °C (-40 to +150 °C)	0.01 °C (-99.9 to +300 °C) 0.1 °C (-200 to -100 °C) 0.1 °C (+300.1 to +800 °C)	1 rpm

Probe type	Type K (NiCr-Ni)	Type S (Pt10Rh-Pt)	Type J (Fe-CuNi)
Meas. range	-200 to +1370 °C	0 to +1760 °C	-200 to +1000 °C
Accuracy ±1 digit	±(0.3 °C + 0.1% of mv)	±1 °C (0 to +1760 °C)	±0.4 °C (-150 to +150 °C) ±1 °C (-200 to -150.1 °C) ±1 °C (+150.1 to +1000 °C)
Resolution	0.1 °C (-200 to +1370 °C)	1 °C (0 to +1760 °C)	0.1 °C (-200 to +1000 °C)

Probe type			
Meas. range	0 to +500 ppm CO	0 to +1 Vol. % CO <sub>2</sub> 0 to +10000 ppm CO <sub>2</sub>	
Accuracy ±1 digit	±5% of mv (0 to +500 ppm CO)	See probe data	
Resolution			

Probe type			
Meas. range	0 to +20 mA	0 to +10 V	
Accuracy ±1 digit	±0.04 mA (0 to +20 mA)	±0.01 V (0 to +10 V)	
Resolution	0.01 mA (0 to +20 mA)	0.01 V (0 to +10 V)	

Oper. temp.	0 to +50 °C	Memory space: 500,000 readings Other features: Automatic recognition of all connected probes Power supply: Battery/rech. batt., alternatively 8V mains unit Battery life in continuous operation with 2 thermocouple probes
Storage temp.	-25 to +60 °C	
Display	LCD, 4 lines	
Battery type	1,5 V AA	
Battery life	18 h	
PC	RS232 interface	
Weight	500 g	
Material/Housing	ABS	
Warranty	3 years	
Memory	45000	

**testo 650**
**Suitable probes at a glance**

Probes Type K (NiCr-Ni)	Illustration	Meas. range	Accuracy	t <sub>99</sub>	Part no.
Thermocouple, made of fibre-glass insulated thermal pipes, pack of 5	<p>2000 mm Please order adapter 0600 1693</p>	-200 to +400 °C	Class 1*	5 s	0644 1109
Quick-action surface probe with sprung thermocouple strip, measuring range short-term to +500°C	<p>150 mm Conn.: Plug-in head, connection cable 0430 0143 or 0430 0145 required</p>	-200 to +300 °C	Class 2*	3 s	0604 0194
Super quick-action surface probe, probe tip at 90° angle, with sprung thermocouple strip	<p>100 mm 50 mm Conn.: Plug-in head, connection cable 0430 0143 or 0430 0145 required</p>	-200 to +300 °C	Class 2*	3 s	0604 0994
Robust surface probe	<p>150 mm 0.4 mm Conn.: Plug-in head, connection cable 0430 0143 or 0430 0145 required</p>	-200 to +600 °C	Class 1*	25 s	0604 9993
Robust surface probe with sprung thermocouple strip for high temperature range up to +700°C	<p>200 mm 0.15 mm Conn.: Fixed cable, coiled 0.3 to 1 m</p>	-200 to +700 °C	Class 2*	3 s	0600 0394
Roller surface probe for measurements on rollers and rotating drums, max. circumferential velocity 18 to 400m/min	<p>274 mm 0.33 mm Conn.: Fixed cable, coiled 0.3 to 1 m</p>	-50 to +240 °C	Class 2*		0600 5093
Magnetic probe, adhesive power approx. 20 N, with magnets, for measurements on metal surfaces	<p>35 mm 0.20 mm Conn.: Fixed cable 1.5 m</p>	-50 to +170 °C	Class 2*		0600 4793
Magnetic probe, adhesive power approx. 10 N, with magnets, for higher temperatures, measures on metal surfaces	<p>75 mm 0.21 mm Conn.: Fixed cable 1.5 m</p>	-50 to +400 °C	Class 2*		0600 4893
Miniature surface probe for measurements on electronic components, small motors...	<p>270 mm 0.5 mm Conn.: Fixed cable 1.5 m</p>	-200 to +400 °C	Class 2*	3 s	0600 1494
Adhesive thermocouple, pack of 2, carrier material: aluminium foil Is fixed at the measuring point using conventional adhesives or silicone heat paste 0554 0004	<p>Diameter extension 2 x 0.2 mm, 0.1 mm thick</p>	-200 to +200 °C	Class 1*		0644 1607
Fast response immersion/penetration probe	<p>150 mm 0.3 mm Conn.: Plug-in head, connection cable 0430 0143 or 0430 0145 required</p>	-200 to +400 °C	Class 1*	3 s	0604 0293
Super quick-action immersion/penetration probe for measurements in liquids	<p>150 mm 0.15 mm Conn.: Plug-in head, connection cable 0430 0143 or 0430 0145 required</p>	-200 to +600 °C	Class 1*	1 s	0604 0493
Super quick-action immersion/penetration probe for high temperatures	<p>470 mm 0.15 mm Conn.: Plug-in head, connection cable 0430 0143 or 0430 0145 required</p>	-200 to +1100 °C	Class 1*	1 s	0604 0593
Super quick-action immersion/penetration probe for measurements in gases and liquids with a low-mass tip	<p>150 mm 0.14 mm 20 mm 0.5 mm Conn.: Plug-in head, connection cable 0430 0143 or 0430 0145 required</p>	-200 to +600 °C	Class 1*	1 s	0604 9794
Robust immersion/penetration probe made of V4A stainless steel, waterproof and oven-proof, e.g. for the food sector	<p>150 mm 0.35 mm 0.3 mm Conn.: Fixed cable 1.5 m</p>	-200 to +400 °C	Class 1*	3 s	0600 2593
Smelting probe for measurements in non-ferrous melting baths, with exchangeable measuring tip Measurement tip lifetime: up to 500 measurements in aluminium smelter	<p>1100 mm 0.65 mm Conn.: Fixed cable 1.5 m</p>	-200 to +1250 °C	Class 1*	60 s	0600 5993
Pipe wrap probe for pipes with diameter of up to 2", for flow/return temp. meas. in hydronic systems	<p>15 mm Conn.: Fixed cable 1.5 m</p>	-60 to +130 °C	Class 2*	5 s	0600 4593
Spare meas. head for pipe wrap probe, TC Type K	<p>35 mm</p>	-60 to +130 °C	Class 2*	5 s	0602 0092

\* According to standard EN 60751, the accuracy of Classes 1/2 refers to -40 to +1000/+1200 °C.

Supplied in Australia by Instrument Choice  
Call our scientists on 1300 737 871  
[www.instrumentchoice.com.au](http://www.instrumentchoice.com.au)

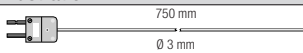
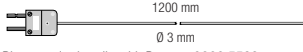
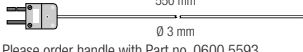
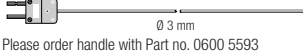
Probes Type K (NiCr-Ni)	Illustration	Meas. range	Accuracy	t99	Part no.
Plug-in measuring tip, 750mm long, flexible, for high temperatures, outer casing: stainless steel 1.4541	 750 mm Ø 3 mm Please order handle with Part no. 0600 5593	-200 to +900 °C	Class 1*	4 s	0600 5393
Plug-in measuring tip, 1200 mm long, flexible, for high temperatures, outer casing: stainless steel 1.4541	 1200 mm Ø 3 mm Please order handle with Part no. 0600 5593	-200 to +900 °C	Class 1*	4 s	0600 5493
Plug-in measuring tip, 550mm long, flexible, for high temperatures, outer casing: Inconel 2.4816	 550 mm Ø 3 mm Please order handle with Part no. 0600 5593	-200 to +1100 °C	Class 1*	4 s	0600 5793
Plug-in measuring tip, 1030mm long, flexible, for high temperatures, outer casing: Inconel 2.4816	 1030 mm Ø 3 mm Please order handle with Part no. 0600 5593	-200 to +1100 °C	Class 1*	4 s	0600 5893

Probes Pt100	Illustration	Meas. range	Accuracy	t99	Part no.
Standard air probe	 150 mm Ø 3 mm Conn.: Plug-in head, connection cable 0430 0143 or 0430 0145 required	-200... +600 °C	Class A**	75 s	0604 9773
Precision air probe	 150 mm Ø 3 mm Conn.: Plug-in head, connection cable 0430 0143 or 0430 0145 required	-100 to +400 °C	1/10 Class B (0 to 100°C) 1/5 Class B (rem. range) to EN 60751**	75 s	0628 0017
Robust surface probe	 150 mm Ø 4 mm Conn.: Plug-in head, connection cable 0430 0143 or 0430 0145 required	-50 to +400 °C	Class B**	40 s	0604 9973
Velcro probe for pipes with diameter of max. 75 mm	 280 mm Conn.: Fixed cable 1.6 m	-50 to +150 °C	Class B**	40 s	0628 0019
Standard immersion/penetration probe	 200 mm Ø 3 mm Stainless Steel Conn.: Plug-in head, connection cable 0430 0143 or 0430 0145 required	-200 to +400 °C	Class A**	20 s	0604 0273
Standard immersion/penetration probe	 200 mm Ø 3 mm Nickel Conn.: Plug-in head, connection cable 0430 0143 or 0430 0145 required	-200 to +600 °C	Class A**	20 s	0604 0274
Highly accurate immersion/penetration probe incl. certificate	 295 mm Ø 4 mm Stainless Steel Conn.: Plug-in head, connection cable 0430 0143 or 0430 0145 required	-40 to +300 °C	±0.05 °C (+0.01 to +100 °C) ±0.05 °C ±0.05% of mv (-40 to 0 °C) ±(0.05 °C ±0.05% of mv) (+100.01 to +300 °C)	60 s	0614 0240
Highly accurate immersion/penetration probe	 200 mm Ø 3 mm Conn.: Plug-in head, connection cable 0430 0143 or 0430 0145 required	-100 to +400 °C	1/10 Class B (0 to 100°C) 1/5 Class B (rem. range) to EN 60751**	30 s	0628 0015
Flexible precision immersion probe, cable heat-proof up to +300°C	 1000 mm Ø 3.5 mm 50 mm Ø 6 mm Conn.: Plug-in head, connection cable 0430 0143 or 0430 0145 required	-100 to +265 °C	1/10 Class B (0 to 100°C) 1/5 Class B (rem. range) to EN 60751**	80 s	0628 0016
Robust immersion/penetration probe with sharpened measuring tip, waterproof and oven-proof	 150 mm Ø 3.5 mm Ø 3 mm Conn.: Fixed cable 1.5 m	-200 to +400 °C	Class A**	30 s	0604 2573







Probes NTC	Illustration	Meas. range	Accuracy	t99	Part no.
Highly accurate air probe for air and gas temperature measurements with bare, mechanically protected sensor	 150 mm Ø 9 mm Conn.: Fixed cable 1.6 m	-40 to +130 °C	To UNI curve	60 s	0610 9714
Globe thermometer to measure radiant heat	 Ø 150 mm Conn.: Fixed cable 1.5 m	0 to +120 °C	±0.5 °C (0 to +49.9 °C) ±1 °C (+50 to +120 °C) Accuracy corresponds to ISO 7243, ISO 7726, DIN EN 27726, DIN 33403 requirements		0554 0670

\*According to standard EN 60584-2, the accuracy of Class 1 refers to -40 to +1000 °C.

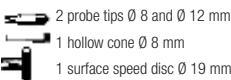

\*\*According to standard EN 60751, the accuracy of Class A and B refer to -200 to +600 °C.

Supplied in Australia by Instrument Choice  
Call our scientists on 1300 737 871  
[www.instrumentchoice.com.au](http://www.instrumentchoice.com.au)

**testo 650**
**Suitable probes at a glance**



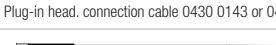
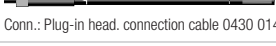

More probes	Illustration	Meas. range	Accuracy	Part no.
Ambient CO probe, for detecting CO in buildings and rooms	 Conn.: Fixed cable 1.5 m	0 to +500 ppm CO	±5% of mv (+100.1 to +500 ppm CO) ±5 ppm CO (0 to +100 ppm CO)	0632 3331
CO <sub>2</sub> probe measures indoor air quality and monitors the workplace. With plug-in head, connection cable 0430 0143 or 0430 0145 required	 Conn.: Plug-in head, connection cable 0430 0143 or 0430 0145 required	0 ... +1 Vol. % CO <sub>2</sub> 0 ... +10000 ppm CO <sub>2</sub>	±(50 ppm CO <sub>2</sub> ±2% of mv)(0 to +5000 ppm CO <sub>2</sub> ) ±(100 ppm CO <sub>2</sub> ±3% of mv)(+5001 to +10000 ppm CO <sub>2</sub> )	0632 1240
Mechanical rpm probe with plug-in head Included  2 probe tips Ø 8 and Ø 12 mm 1 hollow cone Ø 8 mm 1 surface speed disc Ø 19 mm to measure rotational speed: rpm = rotational speed in mm/s	 Conn.: Plug-in head, connection cable 0430 0143 or 0430 0145 required	20 to 20000 rpm	±1 digit	0640 0340
Current/voltage cable (±1 V, ±10 V, 20 mA)		0 to +1000 mV 0 to +10 V 0 to +20 mA	±1 mV (0 to +1000 mV) ±0.01 V (0 to +10 V) ±0.04 mA (0 to +20 mA)	0554 0007
4 to 20 mA interface for connection and intermittent power supply to transmitters (scaling via hand-held instrument), in robust metal housing with impact protection, incl. magnet for fast attachment	 Conn.: Plug-in head, connection cable 0430 0143 or 0430 0145 required	0/4 to 20 mA Channels: 1 channel, transmitter connection via terminal board Auxiliary energy output: 18V DC ± 20% max. connection load: 30 mA	±0.04 mA	0554 0528

Accessories	Part no.
Cable, 1.5 m long, connects probe with plug-in head to meas. instrument, PUR coating material	0430 0143
Cable, 5 m long, connects probe with plug-in head to measuring instrument, PUR coating material	0430 0145
Extension cable, 5 m long, between plug-in head cable and instrument, PUR coating material	0409 0063
Telescopic handle, max. 1 m, for probe with plug-in head, cable: 2.5 m long, PUR coating material	0430 0144
Adapter to connect NiCr-Ni thermocouples and probes with open wire ends	0600 1693
Handle for plug-in measuring tip	0600 5593
Silicone heat paste (14g), Tmax = +260°C, improves heat transfer in surface probes	0554 0004
Spare measuring tip for smelting probe	0363 1712



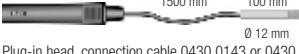

Humidity probes	Illustration	Meas. range	Accuracy	t <sub>99</sub>	Part no.	£
Standard ambient air probe up to +70°C	 Ø 12 mm Conn.: Plug-in head, connection cable 0430 0143 or 0430 0145 required	0 to +100 %RH -20 to +70 °C	±2 %RH (+2 to +98 %RH) ±0.4 °C (-10 to +50 °C) ±0.5 °C (remaining range)	12 s	0636 9740	
Duct humidity/temperature probe, can be connected to telescopic handle 0430 9715	 180 mm Ø 12 mm Conn.: Fixed cable	0 to +100 %RH -20 to +70 °C	±2 %RH (+2 to +98 %RH) ±0.4 °C (-10 to +50 °C) ±0.5 °C (remaining range)	12 s	0636 9715	
Thin humidity probe incl. 4 attachable protection caps for ambient air measurements, measurements in exhaust air ducts and equilibrium moisture measurements	 250 mm Ø 4 mm Plug-in head, connection cable 0430 0143 or 0430 0145 required	0 to +100 %RH -20 to +70 °C	±2 %RH (+2 to +98 %RH) ±0.4 °C (-10 to +50 °C) ±0.5 °C (-20 to -10.1 °C) ±0.5 °C (+50.1 to +70 °C)	15 s	0636 2130	
Highly accurate reference humidity/temp. probe	 Ø 21 mm Conn.: Plug-in head, connection cable 0430 0143 or 0430 0145 required	0 to +100 %RH -20 to +70 °C	±1 %RH (+10 to +90 %RH)* ±2 %RH (remaining range) * ±0.2 °C (+10 to +40 °C) ±0.4 °C (remaining range)	12 s	0636 9741	
Humidity/temperature probe	 Ø 21 mm Conn.: Plug-in head, connection cable 0430 0143 or 0430 0145 required	0... +100 %RH -20 to +70 °C	±2 %RH (+2... +98 %RH) ±0.4 °C (+0.1 to +50 °C) ±0.5 °C (-20 to 0 °C) ±0.5 °C (+50.1 to +70 °C)	12 s	0636 9742	

\* in the temperature range from +15°C to +30°C







Supplied in Australia by Instrument Choice  
Call our scientists on 1300 737 871  
www.instrumentchoice.com.au

Probes Process humidity	Illustration	Meas. range	Accuracy	t99	Part no.	
Standard pressure dew point probe for measurements in compressed air systems		0 to +100 %RH -30 to +50 °C tpd	±0.9 °C tpd (+0.1 to +50 °C tpd) ±1 °C tpd (-4.9 to 0 °C tpd) ±2 °C tpd (-9.9 to -5 °C tpd) ±3 °C tpd (-19.9 to -10 °C tpd) ±4 °C tpd (-30 to -20 °C tpd)	300 s	0636 9840	
Precision pressure dew point probe for measurements in compressed air systems incl. cert. with test point -40 °C tpd		0 to +100 %RH -60 to +50 °C tpd	±0.8 °C tpd (-4.9 to +50 °C tpd) ±1 °C tpd (-9.9 to 0 °C tpd) ±2 °C tpd (-19.9 to -10 °C tpd) ±3 °C tpd (-29.9 to -20 °C tpd) ±4 °C tpd (-40 to -30 °C tpd)	300 s	0636 9841	
High humidity level probe w/ heated sensor element, no humidity on sensor		0 to +100 %RH -20 to +85 °C	±2.5 %RH (0 to +100 %RH)	±0.4 °C (-10 to +50 °C) ±0.5 °C (-20 to -10.1 °C) ±0.5 °C (+50.1 to +100 °C)	30 s	0636 2142 *
Robust high temperature/humidity probe up to +180 °C		0 to +100 %RH -20 to +180 °C	±2 %RH (+2 to +98 %RH)	±0.4 °C (+0.1 to +50 °C) ±0.5 °C (remaining range)	30 s	0628 0021
Flexible humidity probe (does not retain shape) for measurements in inaccessible places		0 to +100 %RH -20 to +180 °C	±2 %RH (+2 to +98 %RH)	±0.4 °C (+0.1 to +50 °C) ±0.5 °C (-20 to 0 °C) ±0.5 °C (+50.1 to +180 °C)	30 s	0628 0022

\* in the temperature range from +10 °C to +30 °C

Probes Material and equilibrium moisture	Illustration	Meas. range	Accuracy	t99	Part no.	
Flexible humidity probe with mini module for meas. e.g. on material testing rigs, module cable length 1500mm, probe tip 50x19x7mm		0 to +100 %RH -20 to +125 °C	±2 %RH (+2 to +98 %RH)	±0.4 °C (-10 to +50 °C) ±0.5 °C (remaining range)	20 s	0628 0013
Sword probe for measuring humidity and temperature in stacked material		0 to +100 %RH -20 to +70 °C	±2 %RH (+2 to +98 %RH)	±0.4 °C (-10 to +50 °C) ±0.5 °C (-20 to -10.1 °C) ±0.5 °C (+50.1 to +70 °C)	12 s	0636 0340
Robust humidity probe e.g. for measuring equilibrium moisture or for measurements in exhaust ducts to +120 °C		0 to +100 %RH -20 to +120 °C	±2 %RH (+2 to +98 %RH)	±0.4 °C (-10 to +50 °C) ±0.5 °C (remaining range)	30 s	0636 2140
Material moisture probe				Free scaling, reference measurement, no water level		0636 0365
Material/building moisture cable		0 to 100 k Ohm = 100 to 0 %		Display values in instrument display mean: 100 to 66 wet; 0 to 1 very dry		0636 0565





Probes aw value	Illustration	Meas. range	Accuracy	t99	Part no.	
aw value set: pressure-tight precision humidity probe with certificate, measurement chamber and 5 sample bowls (plastic)		0 to +1 aW 0 to +100 %RH -20 to +70 °C	±0.01 aW (+0.1 to +0.9 aW) ±0.02 aW (+0.9 to +1 aW)	±0.4 °C (-10 to +50 °C) ±0.5 °C (remaining range)		0628 0024
						Reproducibility of aw value ±0.003







Differential pressure probes	Illustration	Meas. range	Accuracy	Overload	Static pressure	Zeroing	Part no.
Precision pressure probe, 100 Pa, in robust metal housing with impact protection, incl. magnet for fast attachment, to measure differential pressure and flow speeds (in combination with Pitot tube)		0 to +100 Pa	±(0.3 Pa ±0.5% of mv)	50 hPa	100 hPa	one-touch	0638 1347
							Plug-in head, connection cable 0430 0143 or 0430 0145 required
Pressure probe, 10 hPa, in robust metal housing with impact protection incl. magnet for fast attachment, to measure differential pressure and flow speeds (in combination with Pitot tube)		0 to +10 hPa	±0.03 hPa	50 hPa	1000 hPa	one-touch	0638 1447
							Plug-in head, connection cable 0430 0143 or 0430 0145 required
Pressure probe, 100 hPa, in robust metal housing with impact protection, incl. magnet for fast attachment, to measure differential pressure and flow speeds (in combination with Pitot tube)		0 to +100 hPa	±0.5% of mv (+20 to +100 hPa) ±0.1 hPa (0 to +20 hPa)	300 hPa	1000 hPa	one-touch	0638 1547
							Plug-in head, connection cable 0430 0143 or 0430 0145 required
Pressure probe, 1000 hPa, measures differential pressure, in robust metal housing with impact protection, incl. quick-closing coupling (M8 x 0.5), magnet for fast attachment		0 to +1000 hPa	±1 hPa (0 to 200 hPa) ±0.5% of mv (200 to 1000 hPa)	2000 hPa	1000 hPa	one-touch	0638 1647
							Plug-in head, connection cable 0430 0143 or 0430 0145 required
Pressure probe, 2000 hPa, measures differential pressure, in robust metal housing with impact protection, incl. quick-closing coupling (M8 x 0.5), magnet for fast attachment		0 to +2000 hPa	±2 hPa (0 to 400 hPa) ±0.5% of mv (400 to 2000 hPa)	3000 hPa	1000 hPa	one-touch	0638 1747
							Plug-in head, connection cable 0430 0143 or 0430 0145 required
Pressure probe, 2000 hPa, measures absolute pressure, in robust metal housing with impact protection, incl. quick-closing coupling (M8 x 0.5), magnet for fast attachment		0 to +2000 hPa	±5 hPa (0 to +2000 hPa)	4000 hPa		one-touch	0638 1847
							Plug-in head, connection cable 0430 0143 or 0430 0145 required

Supplied in Australia by Instrument Choice  
Call our scientists on 1300 737 871  
[www.instrumentchoice.com.au](http://www.instrumentchoice.com.au)



**testo 650**
**Suitable probes at a glance**

Relative pressure probes	Illustration	Meas. range	Accuracy	Overload	Zeroing	Part no.
Low pressure probe, refrigerant-proof stainless steel, up to 10 bar	 Plug-in head, connection cable 0409 0202 required	-1 to +10 bar	±1% of fsv Overload 25 bar	25 bar	one-touch	0638 1741 screw-in thread 7/16" UNF
High pressure probe, refrigerant-proof stainless steel, up to 30 bar	 Plug-in head, connection cable 0409 0202 required	-1 to +30 bar	±1% of fsv Overload 120 bar	120 bar	one-touch	0638 1841 screw-in thread 7/16" UNF
High pressure probe, refrigerant-proof stainless steel, up to 40 bar	 Plug-in head, connection cable 0409 0202 required	-1 to +40 bar	±1% of fsv Overload 120 bar	120 bar	one-touch	0638 1941 screw-in thread 7/16" UNF
High pressure probe, refrigerant-proof stainless steel, up to 100 bar	 Plug-in head, connection cable 0409 0202 required	-1 to +100 bar	±1% of fsv Overload 250 bar	250 bar	one-touch	0638 2041 Screw-in thread 7/16" UNF
High pressure probe, refrigerant-proof stainless steel, up to 400 bar	 Plug-in head, connection cable 0409 0202 required	-1 to +400 bar	±1% of fsv Overload 600 bar	600 bar	one-touch	0638 2141 Screw-in thread 7/16" UNF

Caps for humidity probes Ø 12mm and 21mm	Illustration	For humidity probes	Part no.
Metal protection cage, Ø 12 mm for humidity probes, material: stainless steel V4A. Quick adjustment time, robust and temperature-proof. Used when measuring velocities of less than 10 m/s.		Ø 12 mm 0636 9740, 0636 9715	0554 0755
Cap with wire mesh filter, Ø 12 mm		All humidity probes with Ø 12 mm	0554 0757
PTFE sintered filter, Ø 21 mm, PTFE. Not affected by condensation, water-repellent, resistant to corrosive substances. Applications: compressed air measurements, high humidity range (continuous measurements), high flow velocities		Ø 21 mm All humidity probes with Ø 21 mm	0554 0666
Sintered PTFE filter, Ø 12 mm material PTFE. Favourable behaviour in condensation, water repellent, high resistance to aggressive media. Applications: Compressed air measurements, high humidity range (long-term measurements), high flow velocities.		Ø 12 mm 0636 9740, 0636 9715	0554 0756
PTFE sintered filter, Ø 12 mm, PTFE. Not affected by condensation, water-repellent, resistant to corrosive substances. Applications: compressed air measurements, high humidity range (continuous measurements), high flow velocities		Ø 12 mm 0628 0021, 0628 0022, 0636 2140, 0636 2142	0554 0758
Stainless steel sintered cap, Ø 21 mm, made of stainless steel V2A. Highly robust, suitable for penetration, clean with compressed air, mechanical protection of sensor. Applications: high mechanical loads, high flow velocities.		Ø 21 mm All humidity probes Ø 21 mm	0554 0640
Stainless steel sintered cap, Ø 12 mm, material: stainless steel V2A. Very rugged, suitable for penetration, can be cleaned with compressed air, mechanical sensor protection. Applications: High mechanical loads, high flow velocities.		Ø 12 mm 0636 9740, 0636 9715	0554 0647
PTFE cap, Ø 5 mm, attachable, PTFE material, (5 off). Applications: dust protection, high humidity level measurements, high flow velocities		Ø 5 mm 0636 2130	0554 1031

Accessories: Humidity probes	Part no.	Accessories: Pressure probes	Part no.
Cable, 1.5 m long, connects probe with plug-in head to meas. instrument PUR coating material	0430 0143	Connection cable, 2.5 m long, for pressure probes 0638 1741/1841/1941/2041/2141	0409 0202
Cable, 5 m long, connects probe with plug-in head to measuring instrument PUR coating material	0430 0145	Adapter for pressure probes, 1/2" outer thread, 1/4" inner thread for pressure probes 0638 1741/1841/1941/2041/2141	0699 3127
Extension cable, 5 m long, between plug-in head cable and instrument PUR coating material	0409 0063	Cable, 1.5 m long, connects probe with plug-in head to meas. instrument PUR coating material	0430 0143
Telescopic handle, max. 1 m, for probe with plug-in head cable: 2.5 m long, PUR coating material	0430 0144	Cable, 5 m long, connects probe with plug-in head to measuring instrument PUR coating material	0430 0145
Telescopic handle, 340 - 800 mm long, for 0636 9715 probe	0430 9715	Connection hose, silicone, 5m long max. load 700 hPa (mbar)	0554 0440
Adapter for surface humidity measurement, for humidity probes Ø 12mm locates damp spots on walls, for example	0628 0012	Connection hose set, 2 x 1 m, coiled, incl. 1/8" screw connection Pressure-tight up to 20 bar, for probe 0638 1647/1747/1847	0554 0441
Cap for bore holes, for humidity probe Ø 12 mm Measures equilibrium moisture in bore holes	0554 2140		
testo saline pots for control and humidity adjustment of humidity probes, 11.3 %RH and 75.3 %RH with adapter for humidity probe	0554 0660		

Supplied in Australia by Instrument Choice  
Call our scientists on 1300 737 871  
[www.instrumentchoice.com.au](http://www.instrumentchoice.com.au)

## Huminator

The Huminator is one of the smallest and therefore one of the most suitable climate chambers available on the market for mobile as well as stationary applications. Humidity readings in the range from 5 to 95%RH can be determined quickly and efficiently stabilised. The built-in temperature control function generates temperatures in the range from 15° to 40°C. Using an appropriate reference, it is possible to carry out fast and easy humidity calibrations on the measuring instruments, probes and data loggers from Testo and other manufacturers. The desk-top instrument is ideally suitable for testing the performance of all types of material, electronic components and instruments under special climatic conditions. The timed programming function facilitates extensive automation of test runs and calibrations, since up to 3 humidity/temperature readings can be activated one after the other. The time for this can be defined by the user.

## Huminator, accurate humidity generator for climate calibrations

- Can be programmed individually
- User-friendly
- LCD display
- High adjustment speed
- RS232 interface



**Huminator with Testo sensor incl. 15 probe adapters (5 of each: 12mm, 21mm, flexible)**

Part no.  
**0519 0801**

### Accessories

Additional Accessories and Spare Parts	Part no.
testo 650, reference humidity meas. instr., readings memory included (up to 500,000 readings), battery, Li cell and calibration protocol 2 channel humidity and temperature meas. instrument with aw value measurement, pressure measurement with option of connecting pressure probes, CO, CO2, rpm, mV/mA transmitters	0563 6501
Mains unit 230 V/ 8 V/ 1 A, for instrument (European plug) for mains operation and battery recharging	0554 1084
Highly accurate reference humidity/temp. probe Plug-in head, connection cable 0430 0143 or 0430 0145 required	0636 9741
Cable, 1.5 m long, connects probe with plug-in head to meas. instrument PUR coating material	0430 0143
Case for Huminator	0519 0820

### Calibration Certificates

DKD calibration certificate/humidity electronic hygrometers; calibration points 11.3%RH and 75.3%RH at +25°C	0520 0206
--	-----------

### Recommended Set

#### Huminator Kit

- Huminator with Testo sensor incl. 15 probe adapters (5 of each: 12mm, 21mm, flexible) (Part no. 0519 0801)
- testo 650, reference humidity meas. instr., readings memory included (up to 500,000 readings), battery, Li cell and calibration protocol (Part no. 0563 6501)
- Mains unit 230 V/ 8 V/ 1 A, for instrument (European plug) (Part no. 0554 1084)
- Highly accurate reference humidity/temp. probe (Part no. 0636 9741)
- Cable, 1.5 m long, connects probe with plug-in head to meas. instrument (Part no. 0430 0143)
- DKD calibration certificate/humidity (Part no. 0520 0206)

### Technical data

Meas. range	+15 to +40 °C +5 to +95 %RH	Meas. chamber dimensions	Diameter: approx. 147 mm Probe imm. depth: app. 170 mm
Accuracy	0.5 °C (10 to 85 %RH at 25 °C) 2 %RH (10 to 85 %RH at 25 °C)	Dimensions	350 x 470 x 200 mm
Stability	0.2 °C (10 to 85 %RH at 25 °C) 1 %RH (10 to 85 %RH at 25 °C)	Display	LCD graphics display
Power supply	85 to 264 VAC, 47 to 63 Hz	Conn.	RS232 interface
		Weight	14.5 kg

Supplied in Australia by Instrument Choice  
Call our scientists on 1300 737 871  
[www.instrumentchoice.com.au](http://www.instrumentchoice.com.au)





Always at your service!

Please send for more information:

Monitoring Instruments for Food Production, Transport and Storage  
Measurement Engineering for Restaurants, Catering and Supermarkets

Measurement Engineering for Air Conditioning and Ventilation

Measurement Engineering for Heating and Installation

Measurement Solutions for Emissions, Service and Thermal Processes

Measurement Solutions for Refrigeration Technology

Stationary Measurement Solutions for Air Conditioning, Drying, Cleanrooms and Compressed Air

Measurement Solutions for Production, Quality Control and Maintenance

Measurement Solutions for Climate Applications in Industry

Reference Measurement Technology for Industry

Measuring Instruments For Temperature

Measuring Instruments for Humidity

Measuring Instruments For Velocity

Measuring Instruments for Pressure and Refrigeration

Multi-Function Measuring Instruments

Measuring Instruments for Flue Gas and Emissions

Measuring Instruments for RPM, Analysis, Current/Voltage

Measuring Instruments For Indoor Air Quality, Light And Sound

Stationary Measurement Technology Humidity / Differential Pressure / Temperature / Process Displays

Stationary Measurement Technology Compressed Air Humidity / Compressed Air Consumption

Supplied in Australia by Instrument Choice  
Call our scientists on 1300 737 871  
[www.instrumentchoice.com.au](http://www.instrumentchoice.com.au)