

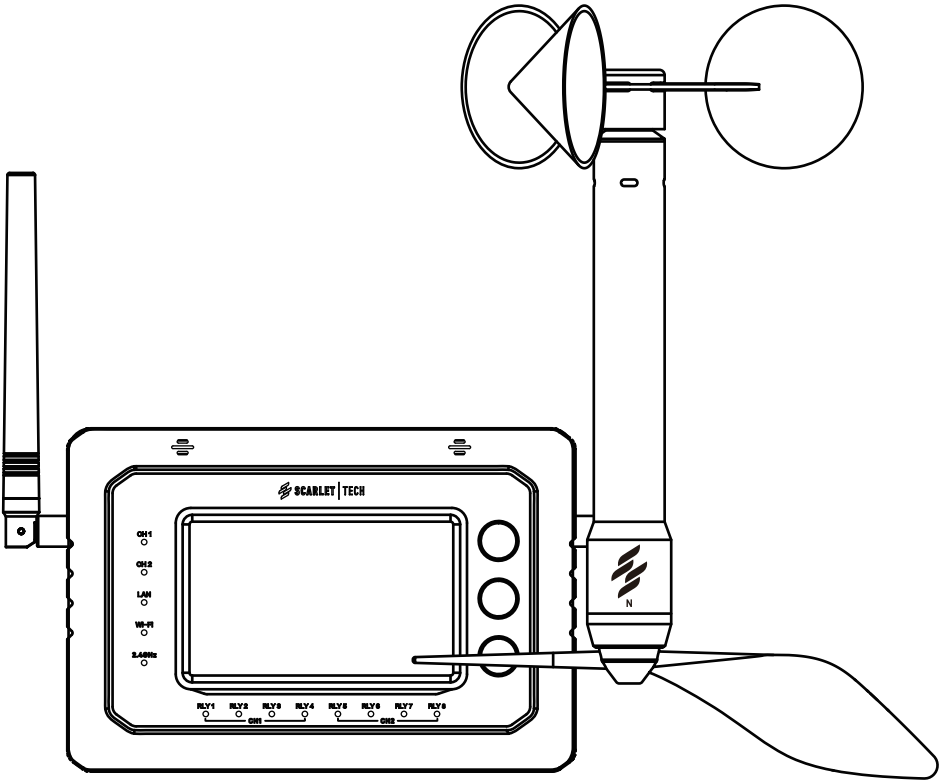

SCARLET | TECH



WindPro

Wireless Anemometer

User Guide

Page Contents

Introduction	2
Packing Contents	3
Overview	4
Technical Specification	7
Operation Interface	9
Installation and Setup	20
WindPro Sensor Installation	20
Console Installation	20
Console Setup	21
Settings	22
Measurements Offset	22
Alarm	22
Relays	23
Data Logging	24
Serial Output	25
Mobile App	25
4-20mA Output	26
Restore to Factory Setting	26
Scarlet Web Portal (OPTIONAL)	27
Safety, Maintenance, & Warranty	30

Introduction

WindPro Online is the ultimate IoT solution to enhance operational safety. Users can access site-specific data remotely, set wind speed and wind direction alerts, and integrate with external devices for control and data acquisition via various outputs. The main hardware consists of a long-range wireless wind sensor and a control console. Users can opt-in to Scarlet Web Portal to access live and historical data, received remote safety alerts, and oversee hardware status anytime, anywhere.

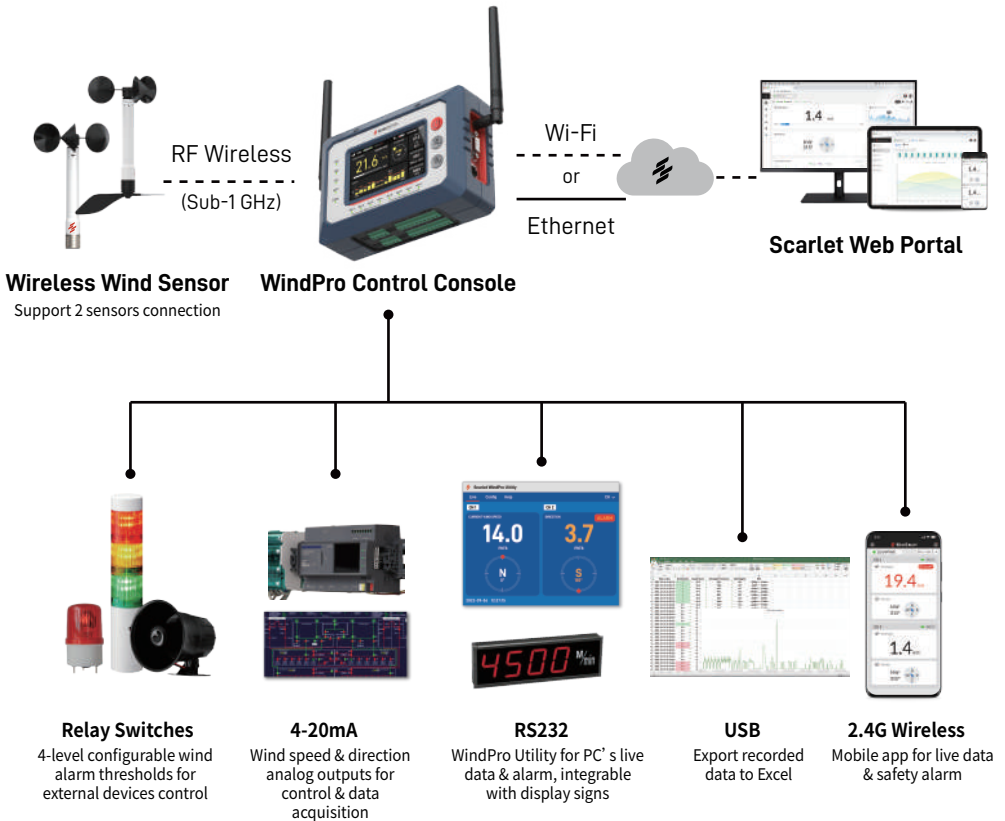

Packing Contents

- WindPro console
- WindPro Antenna x2
- WL-21 Sensor
- Wind Cups
- Magnetic Sensor Mounting bracket & L-shape Hex Key
- Magnet Holder Kit & Quick Release Coupler for WindPro console
- Power Adapter
- User Manual & CoC



WindPro



WindPro
Antenna x2



WL-21
Sensor



Wind
Cups



WL-21 Bracket &
L-shape Hex Key



Power
Adapter



Waterproof
Case

Overview

WindPro

[Front View]



[Left & Right Sides]



[Bottom View (Terminal Block)]

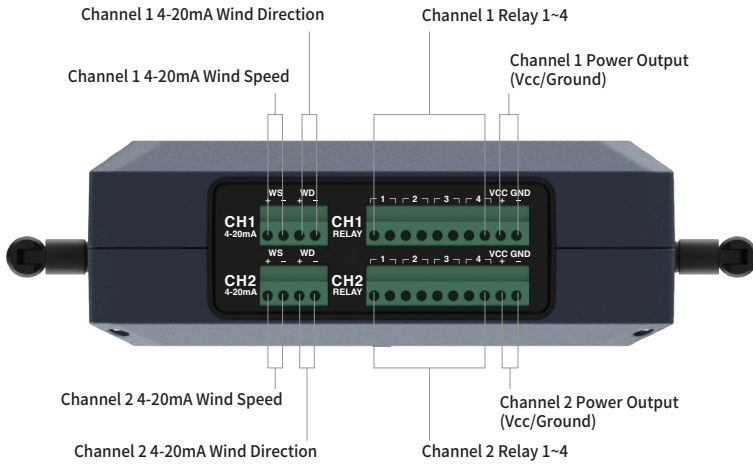

[Rear View]

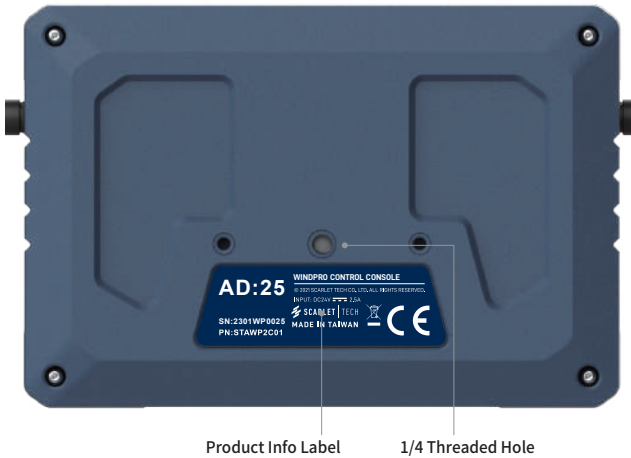

■ Sensor WL-21

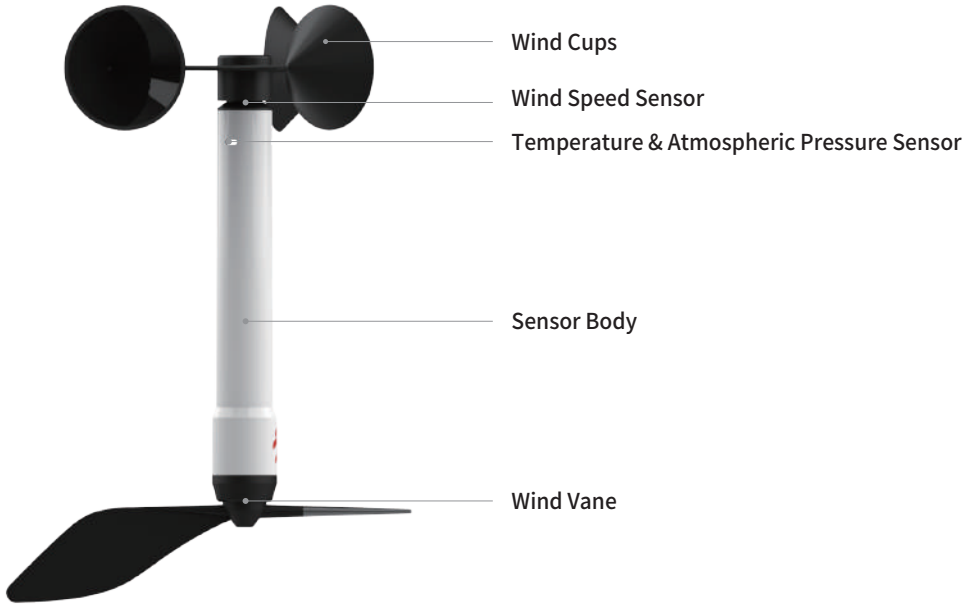

Wireless Connection

Each Wind Sensor has a unique wireless address number pre-paired corresponding to the channel 1 of Control Console. Users can add a 2nd wind sensor to the Control Console channel 2 to monitor the wind data, received alerts, and control external devices from both sensors at the same time.

Wireless Transmission

The Sensor and Receiver are connected through Sub-1GHz wireless band (868/915/933 MHz). The signal strength is display on the Receiver and Web Portal's top corners. For optimal wireless transmission, please make sure the Sensor and Console are in an unobstructed line of sight and are not positioned directly above or below each other.

Technical Specification

WindPro

Item	Description
Dimension	185 x 126 x 65mm
Weight	700g
Display	Touchscreen LCD 4.3" (480 x 272)
Wireless Technology	Sensor: 868 / 915 / 933MHz (Up to 850m in open space) Internet: Wi-Fi 802.11 b/g/n Mobile APP: 2.4GHz Broadcasting
Connector	SMA x2
	RJ45 x1
	RS232 x1
	USB Type C x1
	Power Jack x1
	4-20mA x4 sets
	Relay x8 sets
	VCC GND x2 set
Button	Power On/Off x1
	CH1 Mute x1
	CH2 Mute x1
Power	Input (Power Jack): AC 100-240V
	Output (VCC GND): DC 24V
LED Indicator	Channel Status x2
	LAN Status x1
	Wi-Fi Status x1
	2.4GHz Wireless Status x1
	Alarm x8
Housing Material	PA6+35%GF
Waterproof	N/A

Sensor WL-21

Item	Description
Dimension	262.5 x 183.5 x32mm
Weight	406g
Battery	3.6V 18505 Lithium battery x1 (3 years)
Housing Material	PA6
Waterproof	IP67

Wind Speed

Item	Description
Measurement Unit	m/s (default), knots, MPH, km/hr, ft/s
Measurement Range	0.3...50 m/s
Measurement Resolution	0.1 m/s, 0.1 knots, 0.1 MPH, 0.1 km/hr, 0.1 ft/s
Measurement Accuracy	±2%

Temperature

Item	Description
Measurement Unit	°C (default), °F
Measurement Range	-30°C ~ 60°C
Measurement Resolution	0.1°C, 0.1°F
Measurement Accuracy	±1°C

Atmospheric Pressure

Item	Description
Measurement Unit	hPa, atm, mmHg, bar, Pa, inHg
Measurement Range	500-1100 hPa
Measurement Resolution	1 hPa, 0.001 atm, 0.01 mmHg, 0.001 bar, 100 Pa, 0.01 inHg
Measurement Accuracy	±0.4 hPa

Operation Interface

Operation Flow

Press the **Power** button, to turn on WindPro and enter the **HOME** page (**CH1 INFO**). Swipe right /left on the touch screen to go to the other pages as shown on diagram below:

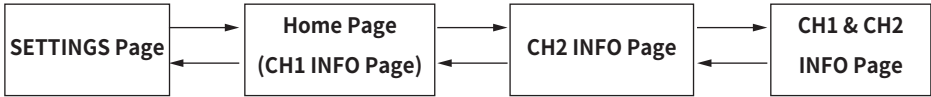

In **SETTINGS**, the user can press  icon back to HOME page, or select options below to go to different setting pages.

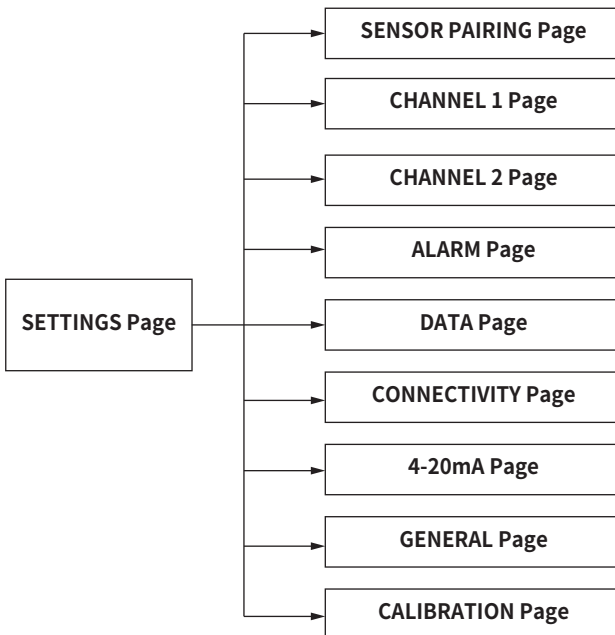

CH1 INFO / CH2 INFO page

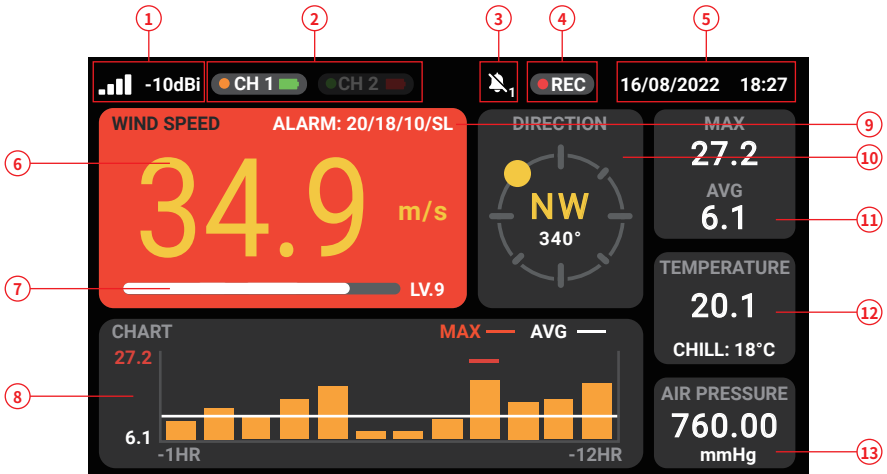

Item	Name	Definition
1	Wireless Signal Status	Wireless signal strength between WindPro & sensor
2	Channel 1/2 Status	The current channel number with the sensor's battery status (connected to sensor#1 or sensor#2)
3	Mute Status	Mute ON or OFF of this channel
4	Data Logging Status	Data logging ON or OFF of this channel
5	Date & Time	Current device date and time of this WindPro
6	Wind Speed	The channel's current wind speed value. Red background indicates the wind speed exceeds the set threshold
7	Beaufort scale	The channel's current Beaufort wind force scale (12 levels in total)
8	Wind Speed Historical Chart	The channel's maximum & average wind speed with hourly wind chart from the past 12 hours
9	Alarm Threshold and Type	The alert thresholds of Alarm 1/ Alarm 2/ Alarm 3/ Alarm 4 First 3 Alarm are wind speed values. Alarm 4 can be set to wind speed, wind direction or sensor connection status
10	Wind Direction	Current wind direction of this channel
11	Maximal & Average Wind Speed	The channel's maximum & average wind speed since this WindPro power-on
12	Temperature & Wind Chill	Current temperature and wind chill of this channel
13	Air Pressure	Current air pressure of this channel

CH1&2 INFO page

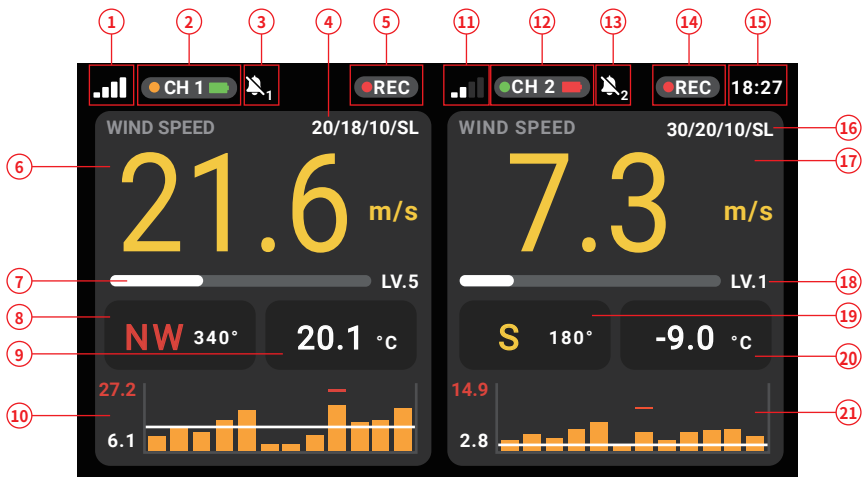

Item	Name	Definition
1	Channel 1 Wireless Signal Status	Wireless signal strength between WindPro & sensor 1
2	Channel 1 Status	Sensor and battery status of channel 1
3	Channel 1 Mute Status	Mute ON or OFF of channel 1
4	Channel 1 Alarm Threshold and Type	Alarm 1, 2 and 3 are wind speed threshold and alarm 4 can be wind speed, wind direction or sensor connection status of channel 1.
5	Channel 1 Data Logging Status	Data logging ON or OFF of channel 1
6	Channel 1 Wind Speed	Current wind speed of channel 1. If the wind speed is over threshold, the background will become red.
7	Channel 1 Beaufort scale	Current Beaufort scale of channel 1
8	Channel 1 Wind Direction	Current wind direction of channel 1
9	Channel 1 Temperature & Wind Chill	Current temperature and wind chill of channel 1
10	Channel 1 Wind Speed Historical Chart	Historical wind speed data chart in past 12 hours of channel 1. It also shows the maximal and average value during this period.
11	Channel 2 Wireless Signal Status	Wireless signal strength between WindPro & sensor 2
12	Channel 2 Status	Sensor and battery status of channel 2
13	Channel 2 Mute Status	Mute ON or OFF of channel 2
14	Channel 2 Data Logging Status	Data logging ON or OFF of channel 2
15	Date & Time	Current device date and time of this WindPro
16	Channel 2 Alarm Threshold and Type	Alarm 1, 2 and 3 are wind speed threshold and alarm 4 can be set to wind speed, wind direction or sensor connection status of channel 2.
17	Channel 2 Wind Speed	Current wind speed of channel 2. If the wind speed is over threshold, the background will become red.
18	Channel 2 Beaufort scale	Current Beaufort scale of channel 2
19	Channel 2 Wind Direction	Current wind direction of channel 2
20	Channel 2 Temperature & Wind Chill	Current temperature and wind chill of channel 2
21	Channel 2 Wind Speed Historical Chart	Historical wind speed data chart in past 12 hours of channel 1. It also shows the maximal and average value during this period.

SETTINGS page

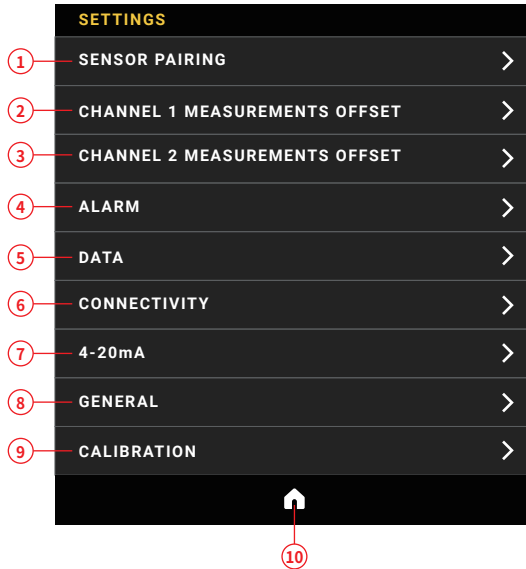

Item	Name	Definition
1	Sensor Pairing	Pair wireless sensor to channel 1 or 2
2	Channel 1 Measurements offset	Set Sensor 1's wind data averaging period, offset, and wind direction correction
3	Channel 2 Measurements offset	Set Sensor 2's wind data averaging period, offset, and wind direction correction
4	Alarm	Alarm and relay related settings for channel 1 & 2
5	Data	Data recording settings and storage management
6	Connectivity	Network, wireless, and cloud related settings
7	4-20mA	4-20mA related settings
8	General	Time, measurement units, and device information
9	Calibration	Wind speed calibration setting
10	Home	Back to HOME page

SENSOR PAIRING page

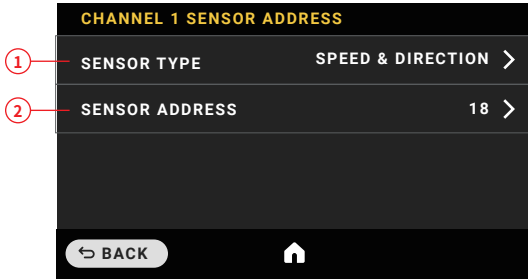

Item	Name	Definition
1	Sensor Type	Speed only (WR-3 Plus Sensor) Speed & Direction (WL-21 Sensor)
2	Sensor Address	Connect to the wireless sensor with the set address number

CHANNEL 1&2 MEASUREMENTS OFFSET

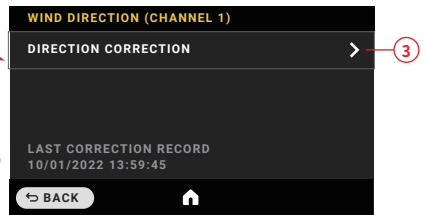
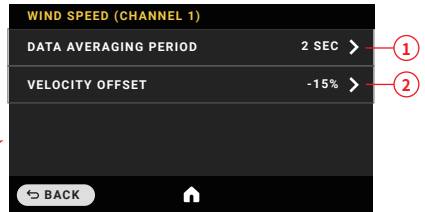
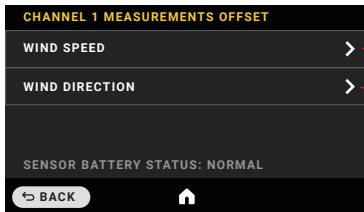

Item	Name	Definition
1	Sensor Averaging Period	Set the averaging period of wind speed measurement showing on the CH1/CH2 INFO page.
2	Velocity Offset	Set the offset value for wind speed measurement showing on the CH1/CH2 INFO page.
3	Direction Correction	Correct the wind direction of the sensor
4	Last Correction Record	Date of the last time the wind direction sensor correction

ALARM Page

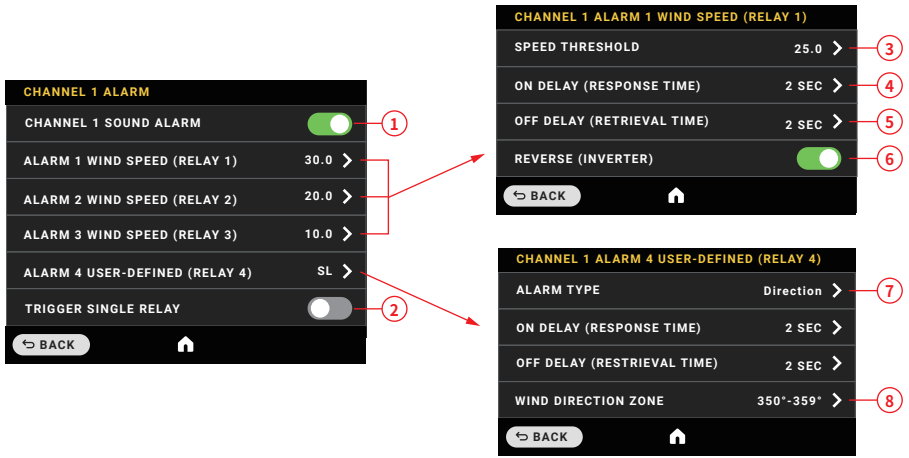

Item	Name	Definition
1	Sound Alarm Mute	Mute the channel sound alarm (Default: ON)
2	Trigger Single Relay	Trigger single for relay this channel. (Default: OFF) ON: Triggered only one relay while the wind speed value over/under the highest/lowest threshold; OFF: Triggered multiple relays while the wind speed value over/under the set thresholds.
3	Speed Threshold	Set the wind speed alarm threshold
4	On Delay	Alert when threshold is triggered after the set time
5	Off Delay	Extend the alarm duration
6	Reverse/Inverter	Reverse the wind speed alarm threshold of this channel. (Default: OFF) ON: alarm triggered while the wind speed is UNDER the threshold; OFF: the alarm triggered while the wind speed is OVER the threshold.
7	Alarm Type	Set alarm triggered event type for Relay 4 (wind speed, wind direction, or sensor signal loss).
8	Wind Direction Zone	Set Relay 4's wind direction alert zone.

DATA LOGGING Page

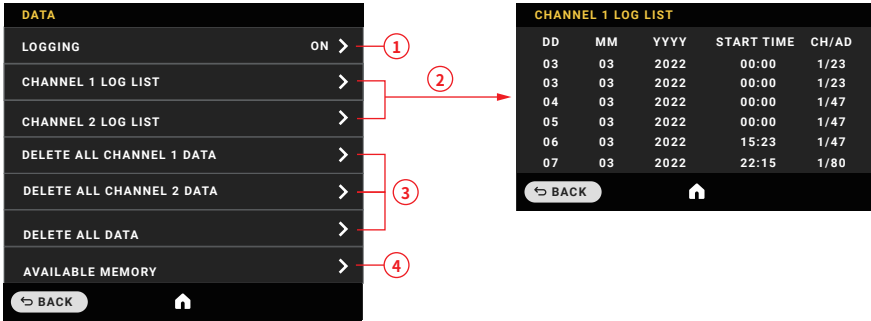

Item	Name	Definition
1	Logging	Control Console's data recording function (Default: ON)
2	Channel 1/2 Log List	Show the list of current log files of channel 1 & 2
3	Delete All Channel 1/2 Data & All Data	
4	Available Memory	

CONNECTIVITY Page

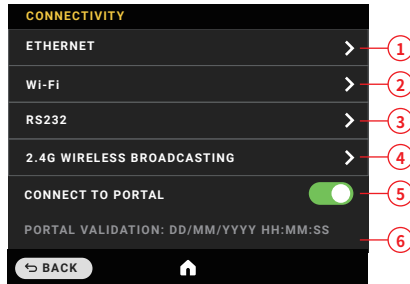

Item	Name	Definition
1	Ethernet	Go to Ethernet connectivity setting page for LAN port
2	Wi-Fi	Go to Wi-Fi connectivity setting page for wireless connection
3	RS232	Go to RS232 connectivity setting page for PC utility
4	2.4G Wireless Broadcasting	Go to 2.4G Wireless connectivity setting page for mobile App
5	Connect to Portal	Connect or disconnect to WindPro Web Portal
6	Portal Validate Date	The last validate date device connected to Web Portal

ETHERNET page

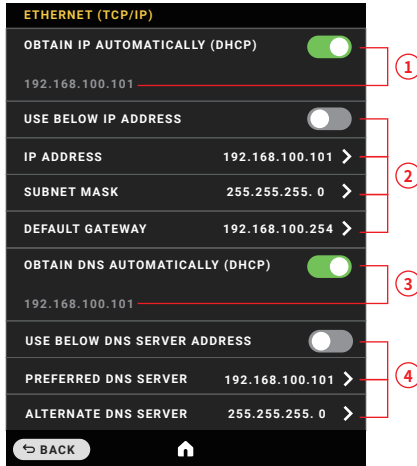

Item	Name	Definition
1	Obtain IP Automatically (DHCP)	The device will get the IP address automatically if connecting to network.
2	Use below IP Address	Set the IP address of this device manually.
3	Obtain DNS Automatically (DHCP)	The device will connect the DNS automatically if connecting to network.
4	Use below DNS Server Address	Set the DNS server address of this device manually.

Wi-Fi page

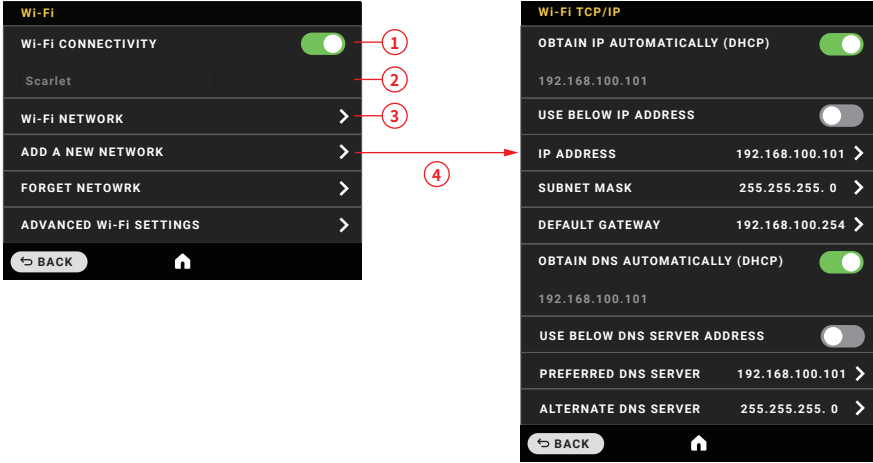

Item	Name	Definition
1	Wi-Fi Connectivity	Switch ON or OFF of Wi-Fi connectivity of this device.
2	Wi-Fi SSID	Show Wi-Fi SSID connected
3	Wi-Fi Network	Search and add this device to one existed W-Fi SSID.
4	Add a New Network	Manually connect this device to one hidden Wi-Fi SSID.
5	Forget Network	Reset Wi-Fi network settings
6	Advanced Wi-Fi Settings	Set TCP/IP setting of Wi-Fi connectivity as Ethernet page.

RS232 page

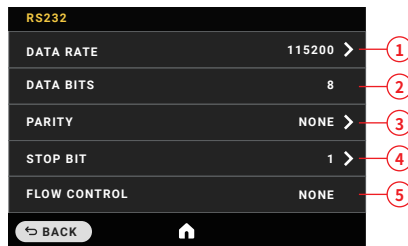

Item	Name	Definition
1	Data Rate	Go to setting page to select different data rate
2	Data Bits	Show data bits setting (Default: 8)
3	Parity	Go to parity setting page
4	Stop Bit	Go to stop bit setting page
5	Flow Control	Show flow control setting (Default: None)

2.4GHZ WIRELESS BROADCASTING page

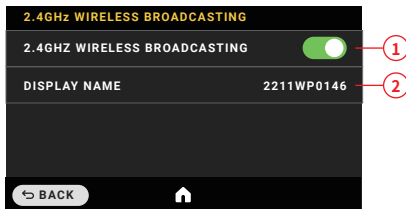

Item	Name	Definition
1	2.4GHz Wireless Broadcasting	Switch ON or OFF of 2.4GHz wireless broadcasting of this device
2	Display Name	Device's name showing on the App

4-20mA page

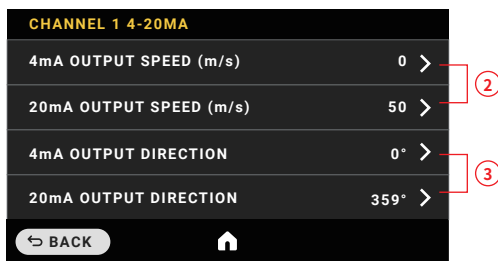
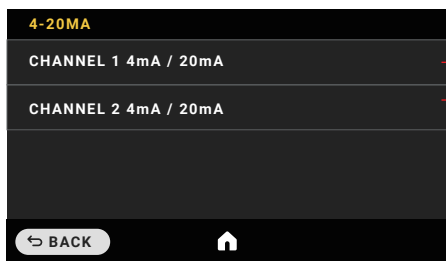

Item	Name	Definition
1	Channel 1/2 4mA/20mA	Go to Channel 1 or 2 4mA/20mA setting page.
2	4mA/20mA Output Speed (m/s)	Set the 4mA/20mA trigger point of wind speed (unit: m/s).
3	4mA/20mA Output Direction (m/s)	Set the 4mA/20mA trigger point of wind direction.

GENERAL page

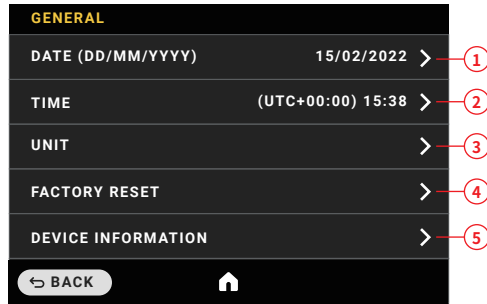

Item	Name	Definition
1	Date	Go to data setting page.
2	Time	Go to time setting page.
3	Unit	Go to measure value setting page.
4	Factory Reset	Do factory reset
5	Device Information	Show the information of the sensors and receiver

CALIBRATION page

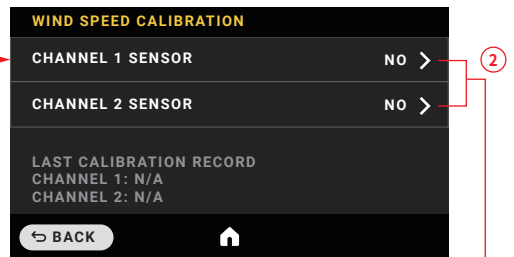
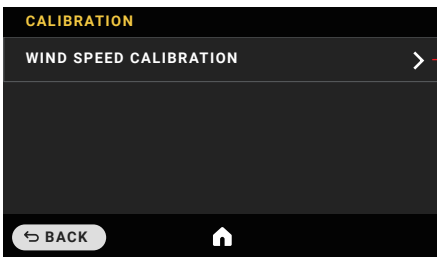

Item	Name	Definition
1	Wind Speed Calibration	Calibrate sensor 1 or sensor 2 wind speed
2	Wind Speed Calibration	Do 5-points wind speed calibration (2m/s, 5m/s, 10m/s, 15m/s, 20m/s)
3	Last Calibration Record	Date of the last time sensor 1 and sensor 2 wind speed are calibrate

Installation and Setup

WindPro Sensor Installation

WindPro's package comes with a Magnetic Sensor Mounting Bracket that supports fast and flexible installation.

1. Loosen the clamp
2. Insert the sensor body from the bottom of the clamp
3. Tighten the clamp
4. Apply wind cups on wind sensor bearing
5. Make sure you hear a "CLICK" sound that indicates all parts are locked in place.
6. Attach the bracket on the desired magnetic surface

Note: Always do orientation correction after deploy the wind sensor. (see Wind Direction Sensor Correction, P21)

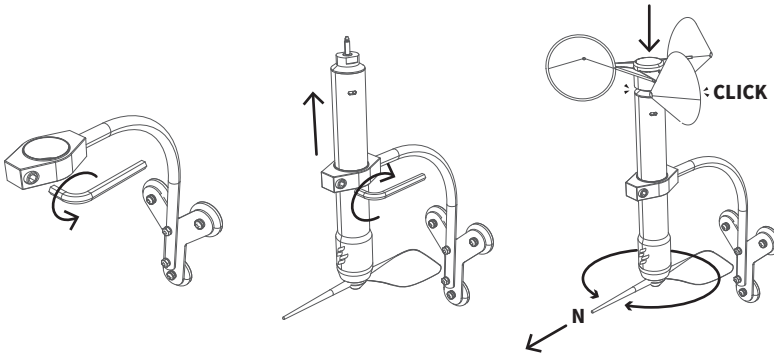

Console Installation

WindPro's Console Holder kit comes with a quick-release support holder with magnetic mount base, a metal flake with one-time adhesive pad, and a quick-release slot with one-time adhesive pad.

1. Clear and dry the mounting surface
2. Peel off the backing paper of the adhesive pads of the metal flake, press and hold it on the mounting surface for 10 seconds
3. Peel off the backing paper of the adhesive pads of the quick-release slot, press and hold it on the back of the WindPro Console for 10 seconds
4. Align the quick-release mounting coupler and attach WindPro's Console to the holder.
5. Adjust the viewing angle by altering the spherical and swiveling joints

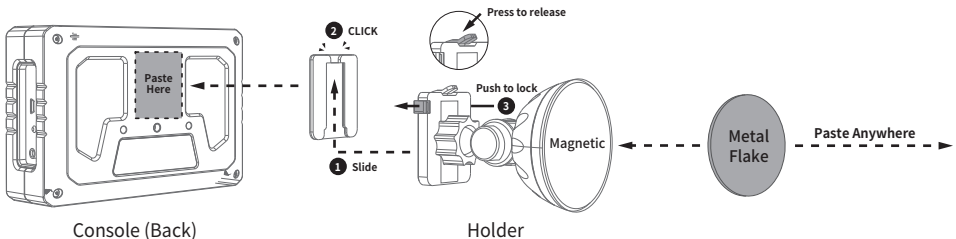

Power Supply

The DC power jack of WindPro Console is at the left side. WindPro package contains a receiver power adapter with type A, C, G, I plug converters.

Power On

- Connect Console with a power outlet using adapter. the device will turn on automatically while the electricity is supplied.
- If the Console has been manually turned off while the power adapter is connected. Please long press the Power button (on the front panel) for more than 3 secs.

Power Off

- Make sure to go back to the Console display's info pages. Long press the panel's Power button for more than 3 secs to turn off the Console then disconnect the power adapter.

Note: Please ensure to connect the power adapter to a properly grounded electrical outlet for safety.

Console Setups

Sensors Pairing

The wireless address number is labeled on the sensor body, as well as in the Settings page of each Console.



Change receiver wireless address:

1. Go to **SETTINGS > SENSOR PAIRING**, select **CHANNEL 1 SENSOR ADDRESS** or **CHANNEL 2 SENSOR ADDRESS**.
2. Change **SENSOR TYPE** to **SPEED & DIRECTION** (for WL-21 sensor) or **SPEED** (for WR-3 Plus sensor).
3. Modify **SENSOR ADDRESS** number in accordance with the Sensor's wireless address number.
4. Once the Sensor and Console are wireless connected, the CH1 or CH2 LED indicator on the Console's left panel will light **GREEN**.

When the wireless connection between sensor and receiver is lost, the channel's LED indicator will turn RED.

Wind Direction Correction

Please make sure to correct the wind direction sensor's orientation each time after the wind sensor deployment.

1. Go to sensor configuration page:
 - a. For channel 1 sensor, go to **SETTINGS > CHANNEL 1 MEASUREMENTS OFFSET**.
 - b. For channel 2 sensor, go to **SETTINGS > CHANNEL 2 MEASUREMENTS OFFSET**.
2. Tap **WIND DIRECTION > DIRECTION CORRECTION** to start the orientation correction process.
3. Follow the instruction on the screen, orient the Sensor's wind vane pointer to the True North.
4. Tap **CONFIRM** to determine the North direction in WindPro.
5. The **LAST CORRECTION** date will be updated when orientation correction succeeds.

Time and Measurement Unit Settings

Change the system date, time zone, and time

1. Go to **SETTINGS > GENERAL**
2. Tap **DATE** to modify system date or tap **TIME (24H)** to modify time zone and system time

Change the display unit of WindPro

1. Go to **SETTINGS > GENERAL > UNIT**
2. Tap and go to the specific parameter settings page
3. Tap to choose desired display unit and tap **CONFIRM** to save the configuration

Settings

Measurements Offset

Data Averaging Period

The data averaging period is the length of time during which wind speed data is gathered and averaged. To change the data averaging period:

1. Go to SETTINGS:
 - a. For channel 1 sensor, go to CHANNEL 1 MEASUREMENTS OFFSET.
 - b. For channel 2 sensor, go to CHANNEL 2 MEASUREMENTS OFFSET.
2. Select WIND SPEED > DATA AVERAGING PERIOD, then modify the data averaging time.

Velocity Offset

Wind speed measurement may be biased by systematic deviation, velocity offset is to increase or decrease the measured wind speed by a fixed percentage to ensure accurate and reliable results.

1. Go to SETTINGS:
 - a. For channel 1 sensor, go to SETTINGS > CHANNEL 1 MEASUREMENTS OFFSET.
 - b. For channel 2 sensor, go to SETTINGS > CHANNEL 2 MEASUREMENTS OFFSET.
2. Tap WIND SPEED > VELOCITY OFFSET, then modify the offset percentage.

Alarm

WindPro provides four configurable alarms for each channel. ALARM 1 to 3 can be set for wind speed values. ALARM 4 is a user-defined alarm that can be triggered based on wind speed thresholds, wind direction zone, or disconnection of the sensor's wireless signal.

If the set threshold is reached, the Console's built-in buzzers will be triggered, the main display and the LED indicators will also flash RED.

Sound Alarm

Turn off Sound Alarm

- Long press the Mute button on WindPro console's right panel for 3 seconds. The Mute icon appears on the top status bar, the sound alarm will be disabled.
- Go to alarm configuration page:
 - For channel 1 sensor, go to SETTINGS > ALARM > CHANNEL 1 ALARM, then tap the switch on CHANNEL 1 SOUND ALARM to turn on/off the sound alarm.
 - For channel 2 sensor, go to SETTINGS > ALARM > CHANNEL 2 ALARM, then tap the switch on CHANNEL 2 SOUND ALARM to turn on/off the sound alarm.

Set wind speed alarm (ALARM 1 - 3)

1. Go to SETTINGS > ALARM
 - a. For channel 1 sensor, go to CHANNEL 1 ALARM
 - b. For channel 2 sensor, go to CHANNEL 2 ALARM
2. Wind Speed Alarm Threshold
 - a. Tap SPEED THRESHOLD, then set the speed by swiping up or down the digits
 - b. Tap CONFIRM to save the warning threshold.

Note: If the REVERSE toggle is turned on, the alarm will be triggered when the wind speed is below the threshold. If it is turned off, the alarm will be triggered when the wind speed is above the threshold.

Relays

Relay connection diagram

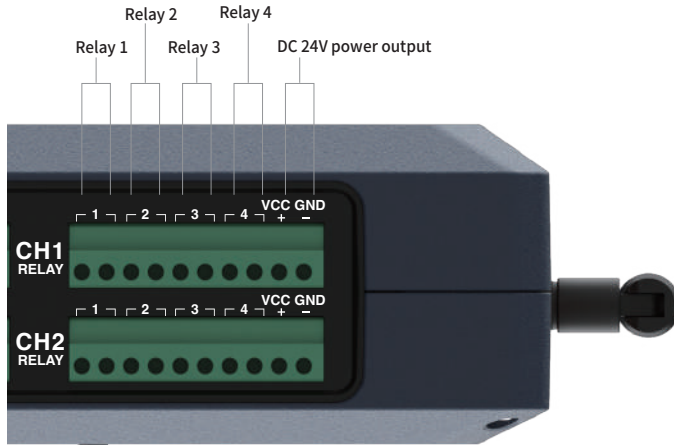

Power supply for external devices

On the right corner of each terminal block of the relay switches, WindPro console provides a DC24V power output for the external device. To connect an external device to the power supply, follow these steps:

1. Connect the power wire of the external device to the VCC terminal.
2. Connect the ground wire of the external device to the GND terminal.

Note: Do not touch any exposed wires or terminals while the power is on. Only qualified professionals should perform installations and maintenance on the terminal block. Ensure that all wires are correctly connected and insulated to prevent short circuits and electrical shock.

Set wind speed alarm threshold (ALARM 4)

1. Go to ALARM 4 USER-DEFINED (RELAY 4) > ALARM TYPE.
2. Select SPEED and tap CONFIRM to browse SPEED THRESHOLD configuration.
3. Set the speed by swiping up or down the digits.
4. Tap CONFIRM to save the configuration.

Set wind direction alarm threshold (ALARM 4)

1. Go to ALARM 4 USER-DEFINED (RELAY 4) > ALARM TYPE.
2. Select DIRECTION and tap CONFIRM to browse WIND DIRECTION ZONE configuration .
3. Swipe up or down the angle values to change it to desired range.
4. Tap CONFIRM to save the configuration.

Set wind sensor disconnection alarm (ALARM 4)

1. Go to ALARM 4 USER-DEFINED (RELAY 4) > ALARM TYPE.
2. Select SIGNAL LOST.
3. Tap CONFIRM to save the configuration.

Set delay timer of the relay

WindPro has two timer functions for each relay. By default, the relay is activated and then switched off immediately while the alarm threshold is triggered.

ON DELAY is the response time of the after the relay switch is activated

OFF DELAY is the alarm retrieval duration.

To use the delay timers, follow these steps:

1. Go to **SETTINGS > ALARM > CHANNEL 1/2 ALARM > Alarm configuration page**.
 - a. To set the ON DELAY timer, go to the channel alarm configuration page, and change the ON DELAY timer (RESPONSE TIME) .
 - b. To set the OFF DELAY timer, go to the channel alarm configuration page, and change the OFF DELAY timer (RETRIEVAL TIME).
2. On the delay timer setting page, swipe up or down to adjust the delay time in seconds, and then tap **CONFIRM** to save the configuration.

Trigger single relay setting

Setup "TRIGGER SINGLE RELAY", "TRIGGER SINGLE RELAY" controls if single or multiple relays are triggered while the warning threshold is reached.

To enable or disable the "Trigger Single Relay" setting:

1. Go to **SETTINGS > ALARM > CHANNEL 1/2 ALARM's bottom page**.
2. Toggle the switch of "TRIGGER SINGLE RELAY" to turn the feature on.
 - a. If the TRIGGER SINGLE RELAY toggle is turned ON, the alarm will trigger only one relay at a time when the wind speed is above the threshold.
 - b. If the TRIGGER SINGLE RELAY toggle is turned OFF, the alarm will trigger multiple relays simultaneously when the wind speed is above the threshold.

■ Data Logging

WindPro Console has a 128MB built-in memory that is capable of recording raw data of wind speed, wind direction, air temperature, and atmospheric pressure (sampling rate every 2 seconds). The logging function is enabled automatically once WindPro is powered on.

Available memory

To check the available memory space of each channel:

1. Go to **SETTINGS > DATA**
2. Tap **AVAILABLE MEMORY**

Turn off Logging function

To export the recorded data, view the log list of each channel, or delete the logged files, the Logging function must be turned OFF.

1. Go to **SETTINGS > DATA**
2. Tap **LOGGING**, then tap **CONFIRM** to stop the logging function

Note: Once Logging is turned off, the WindPro console will no longer record any new data until the function is turned back on or the system is restarted.

Data deletion

If the memory is full, the Logging function will automatically turn off. To continue logging, memory space must be released.

1. Go to **SETTINGS > DATA**
2. Select the option to delete either "All Channel 1 Data," "All Channel 2 Data," or "All Data" and tap **CONFIRM** to delete .

Note: Please disable the Logging function before deleting log files.

3. After the deletion process is complete, it will return to the previous **DATA** setting page.

Note: Please note that once data is deleted, it cannot be recovered, so be sure to export the data before deleting it.

Data export

To export the logged file from the WindPro console, please install the Data Export Software “ScarletWind” on Windows PC.

1. Download and unzip “ScarletWind.zip” file from Scarlet’s website.
2. Connect the WindPro console to PC via USB cable
3. Double click to run the data export software “ScarletWind”
4. Select COM Port of your device, and then click “Detect”
5. The indicator of COM Port will turn Green if the connection is succeeded
6. Choose the download source (WindPro) and select desired channel, and click “Query”
7. All log files of selected channel will be listed
8. Select the file and click “Download”, and then select destination folder
Note: The file format and units of measurement for wind speed, air temperature, and atmospheric pressure are selectable before download.
9. WindPro will start exporting the selected logged file.
10. Wait for the “Finish” pop-up that indicates the data exporting is finished.

Note: Depending on the data amount and PC performance, the time will vary from a few minutes up to several hours.

Serial Output

WindPro features an RS232 serial port that enables measurement data to be transmitted via commands. Scarlet provides the WindPro RS232 Windows Utility for continuous data monitoring. For detailed information on RS232 command, refer to the WindPro RS232 command protocol documentation.

Hardware connection

1. Use a USB-to-RS232 adapter to connect PC and WindPro
2. Open the Device Manager on PC and ensure that the COM port settings are in consistent with the WindPro settings. By default, the serial configuration is 115200, 8, 1, none, none.

WindPro RS232 Utility

1. Download and unzip “WindPro RS232 Utility.zip” file to your PC from Scarlet’s website
2. Double click to run the software “WindPro RS232 Utility”
3. Go to the Config tab and select the COM port of your device and serial configuration. Click "Apply" to save the settings.
4. A pop-up window will appear indicating that the connection has been successful. Click "OK" to close the window and return to the "Live" tab

Mobile App

Scarlet provides the “WindSmart” mobile app that enables users to receive measurement data from the WindPro console directly to their own mobile device. To use this application, follow the instructions below:

Hardware configuration

1. Go to SETTINGS > CONNECTIVITY > 2.4G WIRELESS BROADCASTING
2. Toggle on the 2.4G WIRELESS BROADCASTING switch

Mobile device settings

1. Download “WindSmart” app from App Store or Google Play
2. Tap the WindSmart icon to launch the app.
3. Tap the dropdown on the top left corner to select a device to pair
4. Select your WindPro console from the list of available devices, and then tap Confirm

4-20mA Output

WindPro console provides four 4-20mA current loops for transmitting wind speed and wind direction data to external devices. These loops are assigned with corresponding parameters as follows:

- Channel 1 wind speed
- Channel 1 wind direction
- Channel 2 wind speed
- Channel 2 wind direction

For wind speed, the default output range is 0-50 m/s and for wind direction is 0-359 degrees. If the sensor is disconnected, the output value is 3.6mA, and if the measurement is out of range, the output value is 22.0mA.

Wiring diagram

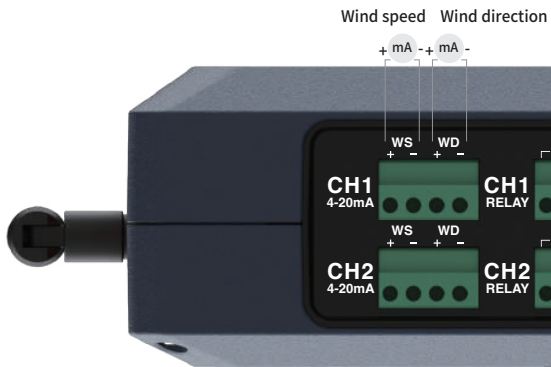

- Connect the positive wire to the 4mA terminal.
- Connect the negative wire to the 20mA terminal.

Restore to Factory Setting

To restore the WindPro to its factory settings, follow the steps:

1. Go to SETTINGS > GENERAL
2. Tap FACTORY RESET
3. Tap CONFIRM to remove all user settings and logged files
4. Press RESET button on the left side of WindPro Console to reboot the device.

Note: All data will be deleted and settings will restore to the factory settings. The action can not be undone.

Scarlet Web Portal (OPTIONAL)

Scarlet WindPro Web Portal is a website-based wind data monitoring platform that enables users to remotely monitor data from the WindPro console. With its intuitive user interface, users can easily browse real-time and historical data in both graph and table formats, and customize alert notifications to stay informed of any critical wind conditions.

Visit <https://windpro.scarlet-tech.com> to register an account and get started.

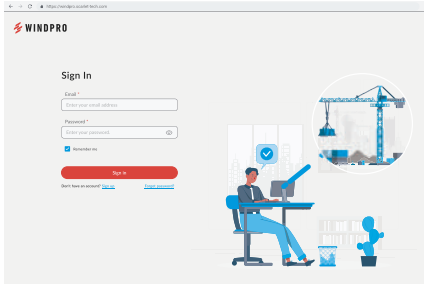

Active WindPro Web Portal Access

1. Go to Device Management and click “Add a device”.
2. Enter WindPro serial number and License code to activate Scarlet WindPro Web Portal access.

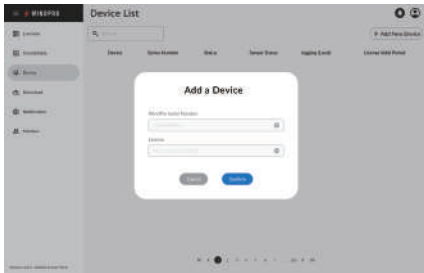

Web Portal Connection

Scarlet’s WindPro WebPortal allows you to access the wind data remotely. To upload the wind data to the WebPortal, the WindPro Console must be connected to the Internet through Ethernet or Wi-Fi.

Ethernet configuration

1. Connect the LAN cable to the RJ45 port.
2. By default, WindPro will obtain an IP address automatically.
3. If you want to manually configure the IP and DNS settings, go to **SETTINGS > CONNECTIVITY > ETHERNET** and make necessary changes.
4. Once the Internet connection is established, WindPro will automatically connect to the WebPortal, and the LAN LED will turn green when the connection is successful .

Wi-Fi configuration

1. Go to **SETTINGS > CONNECTIVITY > Wi-Fi**
2. Toggle the **Wi-Fi CONNECTIVITY** switch to turn on Wi-Fi
3. Choose one of the following options:
 - a. **Wi-Fi NETWORK:** This option will display all nearby available Wi-Fi SSIDs. Tap the SSID you want to connect to and enter the password if required.
 - b. **ADD A NEW Wi-Fi NETWORK:** Join a hidden network by entering the network name and password to connect.
4. Tap **CONFIRM** to save the configuration and return to the previous Wi-Fi configuration page, the SSID will be shown under the **Wi-Fi CONNECTIVITY** if the connection is successfully established.

Monitor WindPro Data

WindPro Console can continuously upload all measurement data to the WebPortal once the device is connected to Internet.

Liveview

The Liveview page displays real-time data uploading by WindPro console, users can choose to view data from a one channel or both channels of a specific WindPro.

Single-channel view

Shows all channel 1 or channel 2 data, you can switch by clicking on the channel label

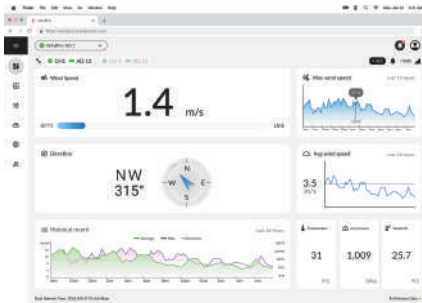

Dual-channel view

Shows both channel 1 and channel 2 data, you can switch between single channel view and dual channel view by clicking on the “enlarge” button.

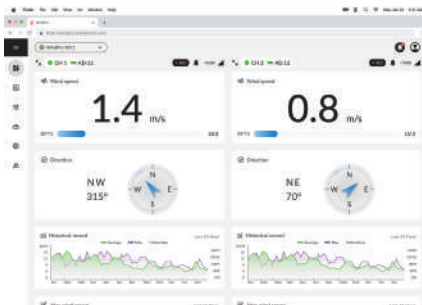

Historical Data (Chart & Table)

The Chart & Table page shows historical data uploaded by the WindPro console. Users can choose to display data in chart or table format at this page.

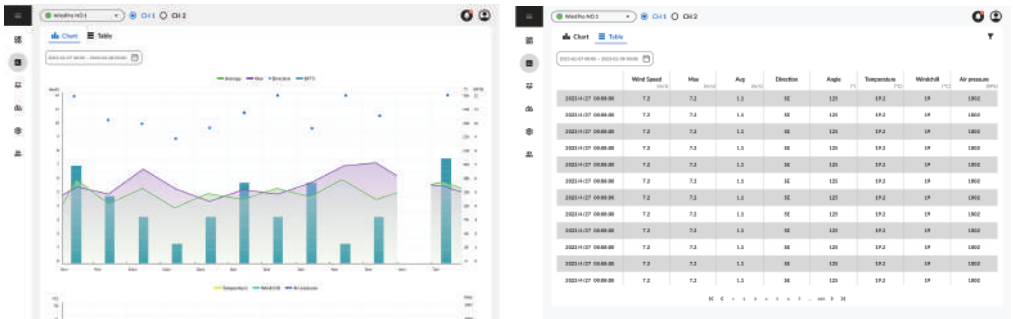

Device Management

The Device page provides a list of all authorized WindPro consoles, shows connection status and device information. Users can use this page to manage and monitor the status of your WindPro consoles.

Data Download

All data uploaded to WindPro WebPortal is securely stored for download. To access and download the data, navigate to the Download page and select desired conversion configuration to download the data in either csv or xls format.

Remote Notification Management

Web Portal offers users the flexibility to personalize their notifications through web browsers or email. Users can set up various types of notification for different events, including the notification's severity level and sound alert preferences.

- **Browser Notification:** When the event is triggered, a pop-up window with a sound alert will display on the screen.
- **Email Notification:** When the event is triggered, all chosen recipients will receive an email containing the alert information.

Note: For detailed information and instructions on how to use the Scarlet WindPro WebPortal, please refer to the WebPortal user guide.

Safety, Maintenance, & Warranty

Operating Environment

The operating temperature of the anemometer system is designed to work in an ambient temperature between 0°C to 50°C (32°F to 122°F) at 20~80%RH. The storage temperature is between -20°C to 60°C (-4°F to 140°F). The instrument can be damaged if stored and operated outside of these temperature ranges. Avoid exposing the instrument to extreme changes of weather and or temperature in a continuous short period of time.

Sensor Battery Replacement

The wireless sensor is powered by a 3.6V 18505 Lithium battery. Its battery can be check by the Receiver (See GENERAL settings page)

- Turn the battery cap near the wind vane counter clockwise to remove it.
- Take out the battery container from the sensor.
- Replace the battery with a new 3.6V 18505 Lithium battery.

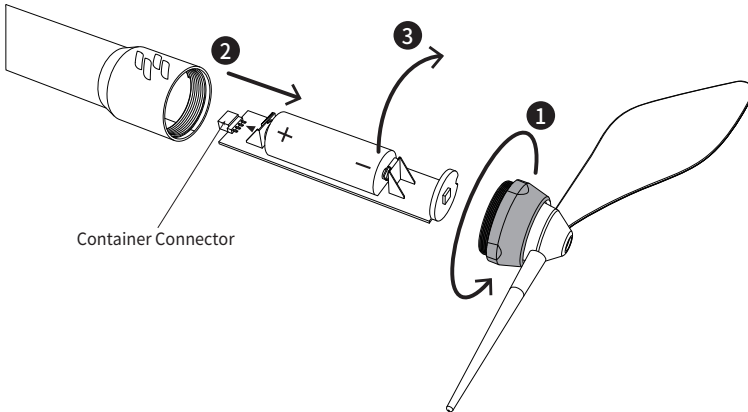

- Put back the battery container into the sensor (Please note the placement direction).

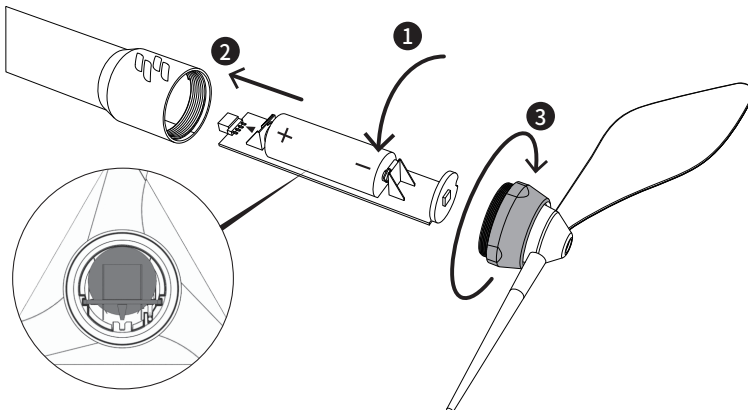

- Make sure the O-ring is correctly aligned to the battery cap for waterproof protection.
- Put back the battery cap in clockwise direction to finish the battery changing.



Warranty Conditions

This instrument is guaranteed for a one-year limited warranty against material or production defects, in accordance with our general sales conditions. During the warranty period, Scarlet Tech reserves the right to decide either to repair or replace the product.

Should you need any reason to return the instrument for repair or replacement, take prior agreements with the local distributor from whom you bought it. Please use the original packaging for return. Do not forget to enclose a report describing the reasons for returning (detected fault). Any damage that occurred in transit due to non-original packaging will be charged to the customer.

Scarlet Tech's One-year Limited Warranty does NOT apply to:

- Accessories and batteries (not covered by warranty)
- Repairs made necessary by improper use or improper combination with incompatible accessories or equipment.
- Repairs made necessary by improper shipping material causing damages in transit.
- Repairs made necessary by previous attempts for the repair carried out by non-skilled or unauthorized personnel.
- Instruments for whatever reason modified by the customer himself without the explicit authorization of our Technical Dept.

The contents of this manual may not be reproduced in any form whatsoever without the authorization from Scarlet Tech.



Scarlet Tech Co., Ltd.
© 2023 Scarlet Tech Co., Ltd. All rights reserved.
4F.-3, No. 347, Sec. 2, Heping E. Rd., Da'an Dist., Taipei City 100, Taiwan
info@scarlet.com.tw
www.scarlet-tech.com

version 230420