

# Instruction Manual

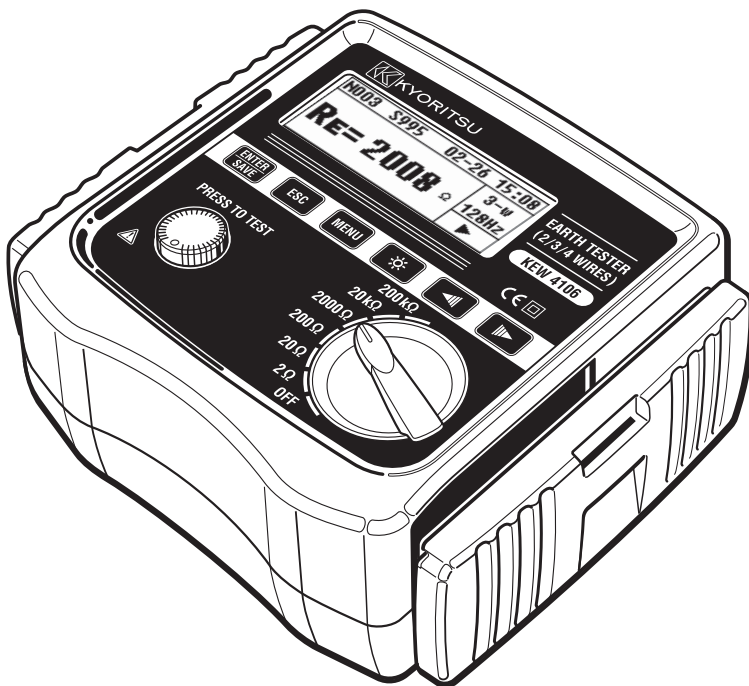

---

Earth Resistance/ Earth Resistivity Tester

---

**KEW 4106**



**KYORITSU ELECTRICAL  
INSTRUMENTS WORKS, LTD.**



---

# Contents

---

1. Safety Warnings .....	1
2. How to store the Cover .....	5
2-1 Method of removing the Cover .....	5
2-2 Method of storing the Cover .....	5
3. Features .....	6
4. Specifications .....	7
5. Instrument Layout .....	10
6. Marks and messages on the LCD .....	13
7. Measurement Principle .....	14
7-1 Principle of Earth Resistance Measurements .....	14
7-2 Principle of Earth Resistivity ( $\rho$ ) Measurements .....	14
8. Preparation for Measurement .....	15
8-1 Battery Voltage Check .....	15
8-2 Settings .....	15
8-2-1 Setting Items .....	15
8-2-2 Setting for Measurement Method .....	16
8-2-3 Setting for Measurement Frequency .....	16
8-2-4 Site (location) No. Setting .....	17
8-2-5 Setting for the interval between Auxiliary Earth Spikes at Earth Resistivity ( $\rho$ ) Measurements .....	18
8-2-6 Date and Time Setting.....	18
8-2-7 Setting for the residual resistance ( $R_k$ ) on the Test Leads .....	21
8-3 Backlight .....	22
8-4 Auto-Power-Off .....	22
8-5 Series Interference Voltage (Earth Voltage) Measurement .....	23
8-6 Auxiliary Earth Resistance Measurement .....	23
8-7 Connection of Earth Test Leads and Simplified Measurement Probes .....	23

9. Measurement Method .....	24
9-1 Earth Resistance Measurement .....	24
9-1-1 Precise Measurement (3-Wire) .....	25
9-1-2 Precise Measurement (4-Wire) .....	27
9-1-3 Simplified Measurement (2-Wire) .....	29
9-2 Earth Resistivity ( $\rho$ ) Measurement .....	31
10. Save/ Recall the Measurement Results .....	34
10-1 How to save the data .....	34
10-2 How to recall the saved data .....	35
10-3 How to delete the saved data .....	35
10-3-1 Delete the data one by one .....	35
10-3-2 Delete the whole data one-time .....	36
10-4 How to transfer the stored data to a PC .....	37
11. Battery and Fuse Replacement .....	38
11-1 Battery Replacement .....	38
11-2 Fuse Replacement .....	38
12. Case and Shoulder strap Assembly .....	40
13. Before Sending for Service .....	41

---

# 1. Safety Warnings

---

This instrument has been designed, manufactured and tested according to IEC 61010: Safety requirements for Electronic Measuring apparatus, and delivered in the best condition after passing quality control tests.

This instruction manual contains warnings and safety rules which have to be observed by the user to ensure safe operation of the instrument and to maintain it in safe condition. Therefore, read through these operating instructions before using the instrument.

## **⚠ WARNING**

- Read through and understand the instructions contained in this manual before using the instrument.
- Keep the manual at hand to enable quick reference whenever necessary.
- The instrument is to be used only in its intended applications.
- Understand and follow all the safety instructions contained in the manual.

It is essential that the above instructions are adhered to. Failure to follow the above instructions may cause injury, instrument damage and/or damage to equipment under test.

- The symbol ⚠ indicated on the instrument, means that the user must refer to the related parts in the manual for safe operation of the instrument.
- Read the instructions following carefully each ⚠ symbol in the manual.

⚠ **DANGER** : is reserved for conditions and actions that are likely to cause serious or fatal injury.

⚠ **WARNING** : is reserved for conditions and actions that can cause serious or fatal injury.

⚠ **CAUTION** : is reserved for conditions and actions that can cause injury or instrument damage.

**⚠ DANGER**

- Never make measurement on a circuit in which electrical potentials exceeding AC/DC300V exist.
- Do not attempt to make measurement in the presence of flammable gasses. Otherwise, the use of the instrument may cause sparking, which can lead to an explosion.
- Never attempt to use the instrument if it's surface or your hand are wet.
- Be careful not to short-circuit the power line with the metal part of the test leads when measuring a voltage. It may cause personal injury.
- Do not exceed the maximum allowable input of any measuring range.
- Do not press the Test Button before connecting the Test Leads.
- Never open the Battery cover during a measurement.



**⚠ WARNING**

- Never attempt to make any measurement if any abnormal conditions, such as a broken cover or exposed metal parts are present on the Instrument and Test Leads.
- Do not rotate the Range Switch with the Test Leads connected to the equipment under test.
- Do not install substitute parts or make any modification to the instrument.  
Return the instrument to your local KEW distributor for repair or re-calibration in case of suspected faulty operation.
- Do not replace batteries if the instrument is wet.
- Ensure that the test leads are firmly inserted into the terminal.
- Set the Range switch to OFF position when opening the Battery cover for battery replacement.

**⚠ CAUTION**

- Set and check the Range switch to the appropriate position before making measurement.
- Set the Range switch to “OFF” position after use and remove the test leads. The instrument consume small current at any range other than OFF, and it shortens the battery life. Remove the batteries if the instrument is to be stored and will not be in use for a long period.
- Do not expose the instrument to direct sunlight, high temperatures, humidity or dew.
- Use a damp cloth with neutral detergent for cleaning the instrument. Do not use abrasives or solvents.
- Do not store the instrument if it is wet. Store it after it dries.
- Use the instrument in following environmental conditions so as not to impair the safety of the instrument.
  - \* Temperature : -10°C ~ 50°C, Altitude: 2000m or less

## Symbols

CAT.IV	The circuit from the service drop to the service entrance, and to the power meter and primary overcurrent protection device (distribution panel)
CAT.III	Primary electrical circuits of the equipment connected directly to the distribution panel, and feeders from the distribution panel to outlets.
	Instrument with double or reinforced insulation
	User must refer to the explanations in the instruction manual.

This instrument meets CAT. III 300V/ CAT.IV150V. To ensure safe operation of measuring instruments, IEC 61010 establishes safety standards for various electrical environments, categorized as CAT.II to CAT.IV, and called measurement categories. Higher-numbered categories correspond to electrical environments with greater momentary energy, so a measuring instrument designed for CAT.III environments can endure greater momentary energy than one designed for CAT.II.

- O : Circuits which are not directly connected to the mains power supply.
- CAT.II : Primary electrical circuits of equipment connected to an AC electrical outlet by a power cord.
- CAT.III : See above table.
- CAT.IV : See above table.



---

## 2. How to store the Cover

---

This instrument has a dedicated Cover to protect against impacts from the outside and prevent the instrument body from becoming dirty. The Cover can be detached and put on the backside of the main body during measurements.

### 2-1 Method of removing the Cover

Slide and pull the Cover in the direction of an arrow.

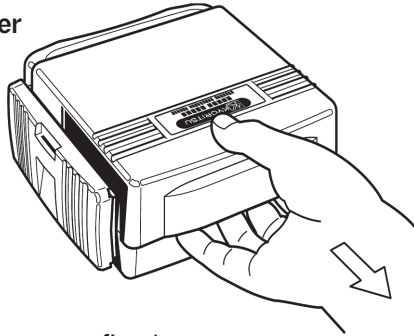

fig. 1

### 2-2 Method of storing the Cover

Turn the Cover, slide and push it in the direction of arrow.

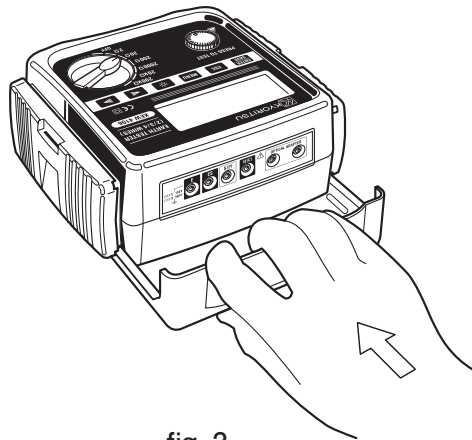

fig. 2

---

## 3. Features

---

KEW4106 is a 2/ 3/ 4-Wire Digital Earth Resistance/ Earth Resistivity Tester equipped with a microcomputer and can measure earth resistances and calculate earth resistivities ( $\rho$ ). This instrument can measure earth resistances on power distribution lines, in-house wiring system and electrical appliances etc. due to the low output voltage: approx 10Vrms or less.

- Designed to meet following safety standards.
  - IEC 61010-1, IEC61010-2-030 (CAT.III 300V, CAT.IV 150V, Pollution degree 2)
  - IEC 61010-031 (Requirements for hand-held Probes)
  - IEC 61557-1, 5 (Earth Resistance Tester)
- Stable measurement results can be obtained under a noisy environment by introducing the FFT (Fast Fourier Transform) technology.
- Dot-matrix 192x64, Monochrome LCD
- Backlight function to view the test results in dimly areas
- Can switch frequencies of measuring signal
  - 4-kind of frequencies : 94 / 105 / 111 / 128Hz, are selectable by hand or automatically.
- Rk Function is available to cancel the residual resistance on the Test Leads.
- Battery Check Function
- Can measure Series Interference Voltage/ Frequency
  - Voltage values and frequencies are displayed when Series Interference voltage (AC) exist.
- Auxiliary Earth Resistance Measurement Function
  - Auxiliary earth resistances are measured and displayed.
- Warning for Auxiliary Earth Resistance Measurements
  - Warnings are displayed on the LCD when auxiliary earth resistances are too high and may result in inaccurate measurements.
- Auto-Power-Off Function
  - The instrument is automatically powered off when 5 min passes without any Key operation.
- Memory Function
  - Can save 800 measured results.
- Communication Interface
  - Can transfer the saved data in the instrument to a PC via a supplied Optical Adaptor.

## 4. Specification

### ● Applicable Standards

IEC 61010-1	Measurement CAT.III 300V, CAT.IV 150V Pollution degree 2
IEC61010-2-030	Measurement CAT.III 300V, CAT. IV 150V Pollution degree 2
IEC 61010-031	Standard for hand-held Probes
IEC 61557-1, 5	Earth Resistance Tester
IEC 61326-1	EMC Standard
IEC 60529	IP 54

### ● Measuring range and accuracy (23°C±5°C, relative humidity 45-75%RH)

Function	Range	Resolution	Measuring Range	Accuracy
Earth Resistance Re (Rg at $\rho$ measurement)	2 $\Omega$	0.001 $\Omega$	0.030~2.099 $\Omega$	$\pm 2\% \text{rdg.} \pm 0.03 \Omega$
	20 $\Omega$	0.01 $\Omega$	0.03~20.99 $\Omega$	$\pm 2\% \text{rdg.} \pm 5 \text{dgt}$ <small>Note 1)</small>
	200 $\Omega$	0.1 $\Omega$	0.3~209.9 $\Omega$	
	2000 $\Omega$	1 $\Omega$	3~2099 $\Omega$	
	20k $\Omega$	10 $\Omega$	0.03k~20.99k $\Omega$	
	200k $\Omega$	100 $\Omega$	0.3k~209.9k $\Omega$	
Auxiliary Earth Resistance Rh , Rs				8% of Re+Rh+Rs
Earth Resistivity $\rho$	2 $\Omega$	0.1 $\Omega \cdot \text{m}$ ~1 $\Omega \cdot \text{m}$ Auto-ranging	0.2~395.6 $\Omega \cdot \text{m}$	$\rho = 2 \times \pi \times a \times Rg$ <small>Note 2)</small>
	20 $\Omega$		0.2~3956 $\Omega \cdot \text{m}$	
	200 $\Omega$		20~39.56k $\Omega \cdot \text{m}$	
	2000 $\Omega$		0.2k~395.6k $\Omega \cdot \text{m}$	
	20k $\Omega$		2.0k~1999k $\Omega \cdot \text{m}$	
	200k $\Omega$			
Series Interference Voltage Ust (A.C only) <small>Note 3)</small>	50V	0.1V	0~50.9Vrms	$\pm 2\% \text{rdg.} \pm 2 \text{dgt}$ (50/60Hz)
				$\pm 3\% \text{rdg.} \pm 2 \text{dgt.}$ (40~500Hz)
Frequency Fst	Auto-ranging	0.1Hz 1Hz	40Hz~499.9Hz	$\pm 1\% \text{rdg.} \pm 2 \text{dgt}$

Note 1) Auxiliary earth resistance is 100  $\Omega$  with Rk correction

Note 2) Depending on the measured Rg. Interval [a] between auxiliary earth spikes is 1.0~30.0m

Note 3) This instrument is not designed to measure voltages on commercial powers.

- Measuring method for Earth Resistance  
Fall-of-potential method (currents and voltages measured via the Probes)
- Measurement method of Earth Resistivity ( $\rho$ )  
Wenner 4-pole method
- Output Characteristics  
Measuring Voltage  $U_m$  (max.) approx 10Vrms 94Hz, 105Hz, 111Hz, 128Hz  
Measuring Current  $I_m$  (max.) approx 80mA, however,  $I_m \times (R_e+R_h) < U_m$
- Measuring Method for Series Interference Voltage (earth voltage)  
RMS Rectifier (between the E-S Terminals)
- Memory Capacity : 800 data
- Communication Interface : Model 8212USB Optical Adaptor
- LCD Dot-matrix 192×64, monochrome  
Backlight  
Earth resistance : max 209.9k $\Omega$   
Earth resistivity : 1999k $\Omega \cdot m$   
Series Interference Voltage : max 50.9V
- Low Battery Warning : Battery mark appears.
- Continuous Measurement : 400 times or more with manganese batteries; repeating measurements at every 30 sec with a load of 1  $\Omega$  at 2  $\Omega$  Range.
- Over-range Indication : “OL”
- Auto-Power-Off : automatically powered off when 5 min passes without any Key operation.
- Location for use : Indoor/ Outdoor use (Not completely waterproof), altitude 2000m or less
- Applicable range : Testing earth resistance on power distribution lines, in-house wiring system and electrical appliances
- Temperature & Humidity range (guaranteed accuracy) :  
23°C±5°C , relative humidity 85% or less (no condensation)
- Operating Temperature & Humidity range :  
-10°C ~ 50°C , relative humidity 75% or less (no condensation)
- Storage Temperature & Humidity range :  
-20°C ~60°C , relative humidity 75% or less (no condensation)
- Overload Protection : between E-S(P) and between E-H(C) terminals  
AC280V / 10 sec
- Withstand Voltage : between the electrical circuit and enclosure  
AC3540V(50/60Hz) / 5 sec
- Insulation Resistance : between the electrical circuit and enclosure  
50M $\Omega$  or more / DC1000 V

- Dimension 167 (L) x 185 (W) x 89 (D) mm
- Weight approx 900g (including batteries)
- Power source DC12V : sizeAA manganese dry battery (R6P) x 8 pcs
- \* **In a use of this instrument under low temperature below 0°C, a use of alkaline batteries with low temperature spec is recommended.**
- Operating instrumental uncertainty  
 Operating instrumental uncertainty (B) is an error obtained within the rated operating conditions, and calculated with the intrinsic error (A), which is an error of the instrument used, and the error (En) due to variations.

$$B = \pm(|A| + 1.15\sqrt{E_2^2 + E_3^2 + E_4^2 + E_5^2})$$

A : Intrinsic error

$E_2$  : Variation due to changing the supply voltage

$E_3$  : Variation due to changing the temperature

$E_4$  : Variation due to series interference voltage

$E_5$  : Variation due to resistance of the probes and auxiliary earth electrode resistance

- Range to keep the maximum operating error

Measurement range within which the maximum operating error ( $\pm 30\%$ ) applies.

2Ω Range : 0.5Ω ~ 2.099Ω

20Ω Range : 2Ω ~ 20.99Ω

200Ω Range : 20Ω ~ 209.9Ω

2000Ω Range : 200Ω ~ 2099Ω

20kΩ Range : 2kΩ ~ 20.99kΩ

200kΩ Range : 20kΩ ~ 209.9kΩ

Variation of Supply Voltage : until the Battery Warning mark appears

Temperature Variation : -10°C ~ 50°C

Series Interference Voltage : 16·2/3Hz, 50Hz, 60Hz, 400Hz and DC3V

\* **No need to consider DC Series interference voltages at 2Ω & 20Ω Ranges**





Auxiliary earth electrode resistance : within following range or 50kΩ or less whichever smaller (At ρ measurements, "Re" in this formula is replaced with "Rg".)

Rh, Rs limit		Accuracy
Re < 0.40Ω	1kΩ	±5%rdg ±1%fs
0.4Ω ≤ Re < 1.00Ω	2kΩ	
1.00Ω ≤ Re < 2.00Ω	3.5kΩ	
2.00Ω ≤ Re	= Rex100 + 5kΩ (Rh, Rs < 50kΩ)	

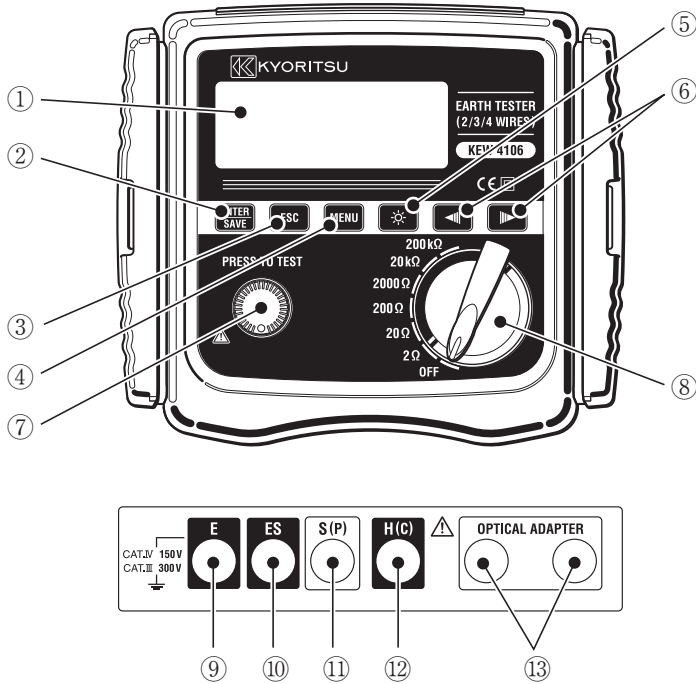
## 5. Instrument Layout

### ● Instrument body and Connector



- ① LCD
- ② ENTER/SAVE Key 
- ③ ESC Key 
- ④ MENU Key 
- ⑤ Backlight Key 
- ⑥ Cursor Key 
- ⑦ TEST Button
- ⑧ Range Switch
- ⑨ Earth Terminal “E”
- ⑩ Probe Terminal “ES” for the Earth Terminal side
- ⑪ Probe Terminal “S”
- ⑫ Auxiliary Earth Terminal for Current “H”
- ⑬ Terminals for Optical Adaptor

● LCD Indications

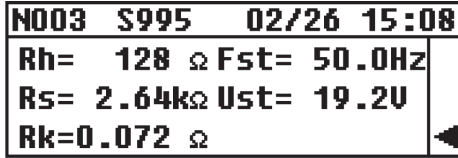
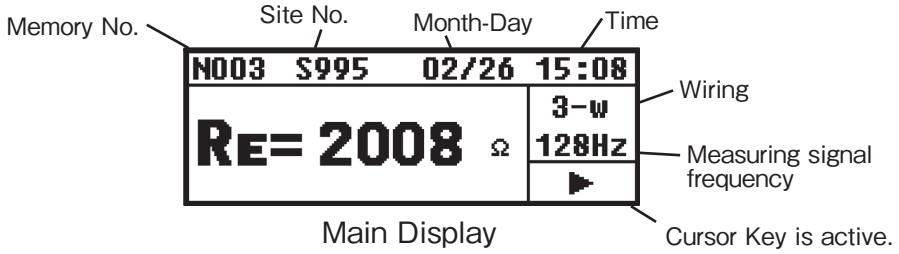

Result Display Screen

● Accessories

⚠ DANGER

- Do not connect the Precision Measurement Test Leads where electrical potentials exceeding 33Vrms with peak value of 46V or DC70V. Please use the Simplified Measurement Test Leads for voltage measurement. The Alligator clips need to be attached and used under CAT. III / IV test environments and the Flat Test Bars are under CAT. II test environment.

Precision Measurement Test Leads MODEL7229A  
(red 40m, yellow 20m, black 20m, green 20m)

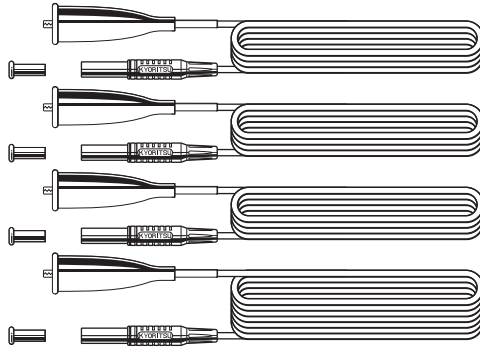

Simplified Measurement Test Leads MODEL7238A

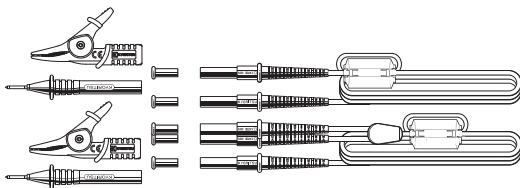

Auxiliary Earth Spike MODEL8032 x 2 sets (4 spikes in total)

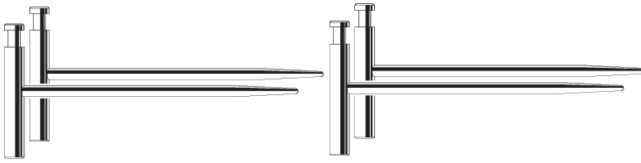

Cord Reel MODEL8200-04 x 1 set (4 reels in total) (for MODEL7229A)

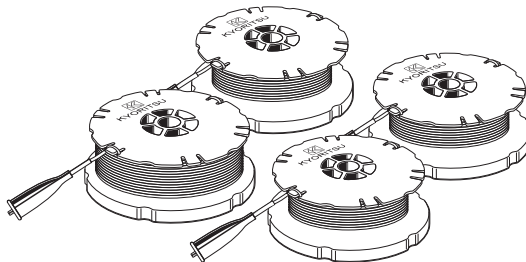

Optical Adaptor MODEL8212USB x 1 set

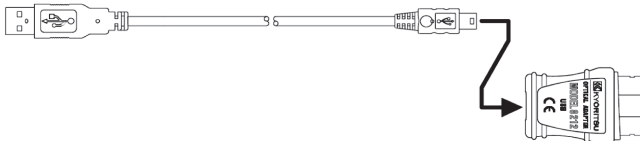

Communication Software CD-ROM “KEW Report” x 1 pce

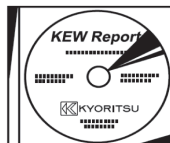

SizeAA Manganese battery (R6P) x 8 pcs

Carrying case MODEL9125

Shoulder strap x 1 pce



## 6. Marks and Messages displayed on the LCD

Following marks and messages are displayed while measurements.

Marks and Messages	Details
<b>BATT</b> <b>Batt Error</b>	Battery voltage is low. Replace the batteries.
<b>Measuring...</b>	This mark is being displayed during a measurement.
<b>OL</b>	Measuring range for the selected Range is exceeded. In case of Ust measurements, 50V or more is detected.
<b>---</b>	Failed to make successful measurements
<b>Rk&gt;limit</b>	Rk is exceeded the limit value; exceeding 2Ω at 2Ω Range and exceeding 9Ω at 20Ω Range.
<b>Range&lt;=20</b>	Setting for Rk can be made at 20Ω or lower
<b>Only 2w/3w/4w</b>	Setting for Rk can be made only at 2w, 3w, 4w measurements.
<b>Voltage High!!</b>	Ust is Regulated value or more.
<b>Rh&gt;limit</b> <b>Rs&gt;limit</b>	Rh and Rs values exceed the allowable range. Correct results might not be obtained.
<b>No Saved data</b>	No saved data exists.
<b>Memory Full</b>	Memory is full. No more data can saved in.
<b>Delete This Item?</b>	A confirmation message before deleting the selected item.
<b>Delete All Items?</b>	A confirmation message before deleting the all items.
<b>Data Success Delete</b>	All items have been deleted.
<b>N003/095</b>	Nxxx is a Memory No., and the left message saying 95 data have been stored. (Displayed at the Data Review Screen.)
<b>N003</b>	Indicating the measured result is saved with Memory No. "N003".
<b>S005</b>	The character "S" stands for "Site". Selectable from 000 to 999.
<b>saved</b>	Data is successfully saved.

## 7. Measurement Principle

### 7-1 Principle of Earth Resistance Measurements

This instrument makes earth resistance measurements with fall-of-potential method, which is a method to obtain earth resistance value “ $R_x$ ” by applying AC current “ $I$ ” between the measurement object “ $E$ ” (earth electrode) and “ $H(C)$ ” (current electrode), and finding out the potential difference “ $V$ ” between “ $E$ ” (earth electrode) and “ $S(P)$ ” (potential electrode). This unit outputs test voltage “ $U_m$ ” to generate AC current “ $I$ ”. Earth resistance value “ $R_x$ ” is determined by the AC current “ $I$ ” and potential difference “ $V$ ”. See Fig. 3.

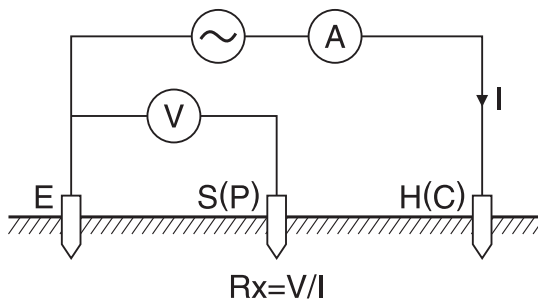

Fig. 3

### 7-2 Principle of Earth Resistivity ( $\rho$ ) Measurements

According to the Wenner 4-pole method, apply AC current “ $I$ ” between the “ $E$ ” (earth electrode) and “ $H(C)$ ” (current electrode) to find out the potential difference “ $V$ ” between the potential electrode “ $S(P)$ ” and auxiliary earth electrodes “ $ES$ ”. (Fig.4)

To obtain the earth resistance “ $R_g(\Omega)$ ”, divide the potential difference “ $V$ ” by AC current “ $I$ ”; where the interval between electrodes is “ $a$ ” (m). Then use a formula:  $\rho = 2 \cdot \pi \cdot a \cdot R_g(\Omega \cdot m)$

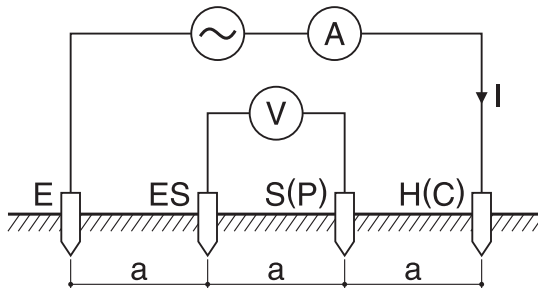

Fig. 4

## 8. Preparation for Measurement

### 8-1 Battery Voltage Check

Power on the instrument. If the display is clear without the Low battery mark " **BATT** " showing, battery voltage is sufficient. If the display blanks or the Low battery mark is indicated (Fig.5), replace the batteries according to "11. for Battery and Fuse Replacement".

N003 S995		<b>BATT</b>	15:08
<b>RE= 2008</b> Ω		3-w	128Hz
			▶

Fig. 5 Low battery mark

Note) Measurements cannot be made, even the Test Button is pressed, while the Low Battery Mark is displayed on the LCD. Measurements are halt when the Low Battery Mark appears on the LCD.

### 8-2 Settings

#### 8-2-1 Setting Items

This instrument starts with Measurement mode (Fig.6 Main Screen) when it is powered on while the Range Switch has been set to the position other than "OFF".

N003 S995		02/26	15:08
<b>RE= 2008</b> Ω		3-w	128Hz
			▶

Fig. 6 Main Screen

Measurement conditions should be set before starting measurements. Setting the date and time enables a saving measured data with time information. Press the " **MENU** " Key and enter into the "SYSTEM\_MENU" (Fig.7). Then select "CONFIG\_SETTING" with Cursor Keys, and press the " **ENTER SAVE** " Key to enter into the CONFIG\_SETTING mode. (Fig.8) Pressing the " **ESC** " Key twice exits from the CONFIG\_SETTING mode and returns to Measurement mode.

SYSTEM_MENU 02/26 15:08	
Review Data	
Config Setting	

Fig. 7

CONFIG_SETTING	
Wire(ρ)	Freq(94)
Site(111)	Lh(14.5)
Date/Time	Rk(0.005)

Fig. 8

Settings of following parameters can be made on this instrument

- Wire : Measurement method (Wiring System)
- Freq : Measurement frequency
- Site : Site (location) No
- Lh : Interval of the auxiliary earth spikes at Earth resistivity ( $\rho$ ) measurement
- Date/Time : Year/ Month/ Day, Time (24-hour display)
- Rk : Residual resistance on the Test Leads

### 8-2-2 Setting for Measurement Method

Measurement method is selectable from: 2-wire (2-wire system), 3-wire (3-wire system), 4-wire (4-wire system) and  $\rho$  (earth resistivity).

Select “Wire” with the Cursor Key on the CONFIG\_SETTING Screen and press the “” Key to proceed to the Wiring Setting Screen. (Fig.9)

Fig. 9



Select the appropriate Wiring System with the Cursor Key and press the “” Key. Then the CONFIG\_SETTING Screen with the selected Wiring System will be displayed .

Fig. 10

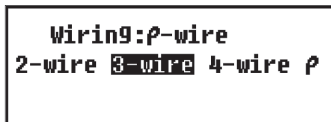

### 8-2-3 Setting for Measurement Frequency

Measurement signal frequencies can be selected from following four frequency bands with this instrument in order to minimize the influence of the series interference voltage (earth voltage).

\*Auto \*94Hz \*105Hz \*111Hz \*128Hz



The instrument automatically select the best suitable frequency when selecting “Auto” and output the frequency signal. Select “Freq” with the Cursor Key on the CONFIG\_SETTING Screen and press the “” Key to display the Frequency Setting Screen (Fig.11).

Fig. 11



Selecting a desirable frequency with the Cursor Key, and pressing the “” Key returns to the “CONFIG\_SETTING” Screen (Fig.12) with the selected frequency.

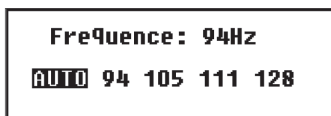

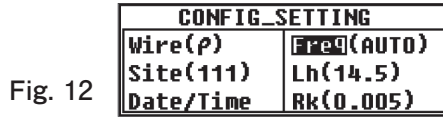

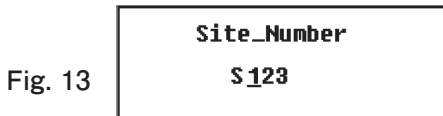

#### 8-2-4 Site (location) No. Setting

The site (location) where measurements done can be saved with numbers. Select “Site” with the Cursor Key on the CONFIG\_SETTING Screen, and press the “” Key to display the Site\_Number Setting Screen (Fig.13).

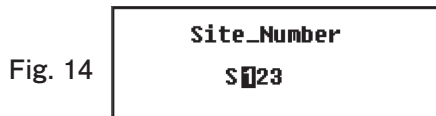

Select any digit to be changed with the Cursor Key, and press the “” Key. Then the selected digit is highlighted and ready to be changed. (Fig.14)



Press the Right Cursor Key  to increase numbers and the Left Cursor Key  to reduce numbers. Keep the Cursor Key pressed down to change numbers quickly. Press the “” Key to confirm a number.

Repeat this procedure to change the other digits. Press the “” Key when settings are done. Then the CONFIG\_SETTING Screen (Fig.15) with the selected Site No. will be displayed.

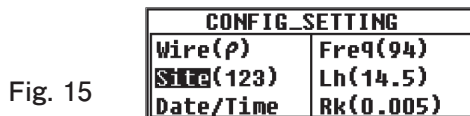

Note) Site No. is selectable from 000 to 999.

### 8-2-5 Setting for the interval between Auxiliary Earth Spikes at Earth Resistivity ( $\rho$ ) Measurements

Making setting of the intervals between auxiliary earth spikes is necessary to measure earth resistivity ( $\rho$ ).

Select “Lh” with the Cursor Key on the CONFIG\_SETTING Screen, and press the “” Key to display the Length Setting Screen (Fig.16).



Fig. 16

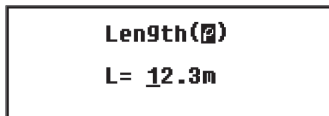
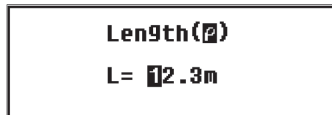

Select any digit to be changed with the Cursor Key, and press the “” Key. Then the selected digit is highlighted and ready to be changed. (Fig.17)

Fig. 17



Press the Right Cursor Key  to increase numbers and the Left Cursor Key  to reduce numbers. Keep the Cursor Key pressed down to change numbers quickly. Press the “” Key to confirm a number.



Repeat this procedure to change the other digits. Press the “” Key when settings are done. Then the CONFIG\_SETTING Screen (Fig.18) with a new interval will be displayed.

Fig. 18



**Note)** Intervals can be set within a range of 1.0 to 30.0m. If a longer interval out of this range is entered at the Setting Screen, it automatically changed to “30.0m” when pressing the “” Key.

**Note)** Intervals up to 20m can be selected with the supplied Test Leads MODEL 7229A.

### 8-2-6 Date and Time Setting

This instrument has a clock function and can save the measured data with time and date information. The clock will not be reset once it has been set even after powering off the instrument. A manual adjustment is required to keep the clock time always right.

Time Setting can be done in following procedure.

Select “Date/Time” with the Cursor Key on the CONFIG\_SETTING Screen, and press the “” Key to display the Time and Date Setting Screen (Fig.19).

Fig. 19



### (1) Time Setting

Put the cursor on “Time” and press the “” Key to display the Time Setting Screen (Fig.20).

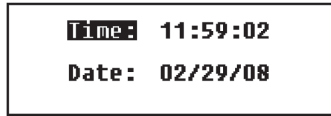
Fig. 20





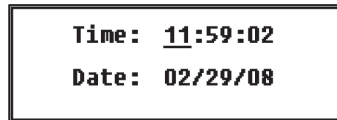

Select a parameter to be changed with the Cursor Key, and press the “” Key. Then the selected digit is highlighted and ready to be changed. (Fig.21)  
The clock is 24-hour display.

Fig. 21

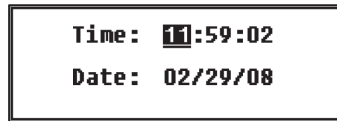

Press the Right Cursor Key  to increase numbers and the Left Cursor Key  to reduce numbers. Keep the Cursor Key pressed down to change numbers quickly. Press the “” Key to confirm a number.



Repeat this procedure to change the other digits. Pressing the “” Key when settings are done returns to the Time/Date Setting Screen (Fig.22).

Fig. 22

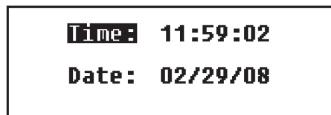

To change the date, proceed to Step(2). Press the “” Key again to exit from the setting mode and return to the CONFIG\_SETTING Screen. Then the clock starts.

## (2) Date Setting

Date is displayed in the following order: Month/ Day/ Year.

Put the cursor on "Date" and press the "  " Key to display the Date Setting Screen (Fig.23).

Fig. 23



Select a parameter to be changed with the Cursor Key, and press the "  " Key. Then the selected digit is highlighted and ready to be changed. (Fig.24)

Fig. 24

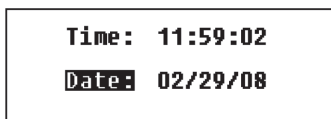





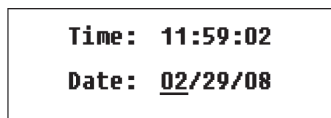

Press the Right Cursor Key  to increase numbers and the Left Cursor Key  to reduce numbers. Keep the Cursor Key pressed down to change numbers quickly. Press the "  " Key to confirm a number. Repeat this procedure to change the other digits. Pressing the "  " Key when settings are done returns to the Time/Date Setting Screen (Fig.25).

Fig. 25

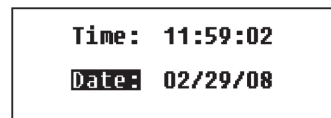

Press the "  " Key again to exit from the setting mode and return to the CONFIG\_SETTING Screen. Then the clock starts.

**Note) The second is not displayed on the Main Screen; only hours and minutes are displayed.**

**Note) The backup battery may be exhausted when clock becomes wrong after powering on/off the instrument. In this case, please contact our local distributor. The life time of the backup battery is approx 5 years.**



### 8-2-7 Setting for the residual resistance (Rk) on the Test Leads

This instrument can store the residual resistance (Rk) of the Test Leads before starting Re measurements on 2/ 3/ 4-wire system, and can deduct the resistance from the measured result. The setting of Rk can be done in following procedure.

**Note) Connections of Test leads vary by measurement methods.**

See the corresponding pages for further details.

**Note) Rk cannot be saved while the Low Battery Mark **BATT** or **Batt Error** is displayed on the LCD.**

Select the 2Ω or 20Ω Range.

Select “Rk” with the Cursor Key on the CONFIG\_SETTING Screen, and press the “” Key to display the Rk Setting Screen (Fig.26)

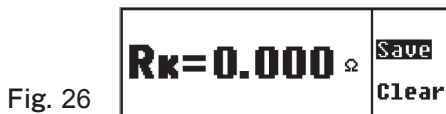



Fig. 26

Press the Test Button to measure Rk. The measured results will not be saved until the “” Button is pressed. The CONFIG\_SETTING Screen (Fig.27) is displayed when the Button is pressed down and the data is saved.

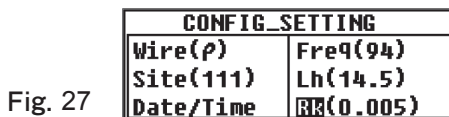



Fig. 27

The Rk value is being kept even powering off the instrument. To clear the saved Rk values, select “Clear” on the Rk Setting Screen (Fig.28) and press the “” Key. Then the value restores to “0.000Ω”.

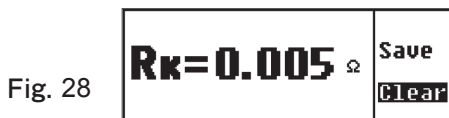

Fig. 28

Then CONFIG\_SETTING Screen (Fig.29) is displayed again.

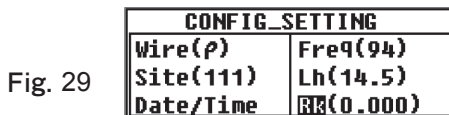

Fig. 29

**Note) Rk values exceeding following values cannot be saved.**

2Ω Range: max 2Ω, 20Ω Range: max 9Ω

A message shown in Fig.30 is displayed when the measured Rk is exceeding above values.

**Note) The message shown in Fig.30 is also displayed when a fuse blows.**

Fig. 30



Following message appears and shows that the data cannot be saved when the “” Key is pressed with above display.

Fig. 31



Note) Following message appears and shows that the data cannot be saved when trying to save Rk at 200kΩ or upper Ranges. The Rk values saved at 2Ω and 20Ω Ranges are kept effective at 200kΩ or upper Ranges.

Fig. 32





Note) Following message appears and shows that the data cannot be saved when trying to save Rk at Wire ( $\rho$ ) measurements.

Fig. 33



### 8-3 Backlight

To facilitate working in dimly lit situations or in night time, a backlight function is provided which illuminates the LCD. Press the “” Key to operate this function. The backlight will light up for about 30 sec and turned off automatically. Pressing the “” Key while the backlight is on can turn it off by manual.

### 8-4 Auto-Power-Off

This instrument is automatically powered off about in 5 min after the last switch operation. To exit from the auto-power-off mode, set the Range Switch to “OFF” position once, and re-set it to the Range at which a measurement to be conducted.

### 8-5 Series Interference Voltage (Earth Voltage) Measurement

Measurements are automatically started during a measurement of earth resistances and earth resistivities, and the results can be checked on the Result display screen.

Warning message “Voltage High!” is displayed on the Main display when the earth voltage ( $U_{st}$ ) is high.

2 $\Omega$ /20 $\Omega$  Range : “Voltage High!” warning appears when the voltage is 12V or higher. Earth resistance measurement cannot be made when the voltage exceeds 15V.

200 $\Omega$  ~ 200k $\Omega$  Range : “Voltage High!” warning appears when the voltage is 15V or higher. Earth resistance measurement cannot be made when the voltage exceeds 20V.

**Note) DC series interference voltages cannot be measured.**

### 8-6 Auxiliary Earth Resistance Measurement

This instrument can measure and display the auxiliary earth resistances ( $R_h$ ,  $R_s$ ). When the  $R_h$  or  $R_s$  value is more than Regulated value or “50k $\Omega$ ”, a warning message “**R<sub>h</sub>>limit**” or “**R<sub>s</sub>>limit**” appear. The LCD shows “ $R_h=OL$   $\Omega$ ” or “ $R_s=OL$ ” when the  $R_h$  or  $R_s$  values exceed 50k $\Omega$ . These parameters are measured automatically at auxiliary earth resistance measurements, and can be checked on the Result Display Screen.

**Note)  $R_h$  and  $R_s$  stand for Auxiliary Earth Pole H(C) and the Auxiliary Earth Resistance of S(P) respectively.**

### 8-7 Connection of Earth Test Leads and Simplified Measurement Probes

Connect the Earth Test Leads and Simplified Measurement Probes to the connectors on the instrument firmly. Otherwise, a contact failure occurs and wrong results may be read out on the LCD.

**Note) Some numbers other than “OL” may be displayed on the LCD when making measurement without connecting any cord or probe at 200 $\Omega$  or upper Ranges. This is not a malfunction.**

## 9. Measurement Method

### ⚠ DANGER

- No voltage should be applied between the measuring terminals at earth resistance measurements.

### 9-1 Earth Resistance Measurement

### ⚠ CAUTION

- The measured results may be influenced by induction if measurements are made with the Test Leads twisted or in touch with each other. When connecting the Probes, they should be separated.

Note) When measuring multi-earthed system such as interconnected towers and electrical poles with this instrument, the measured results smaller than the values of single-earthed system are obtained since these earth resistance can be considered that they are connected in parallel. Let' s regard earth resistance under test as  $R_x$ , and the other earth resistances as  $R_1, R_2, \dots, R_n$ .

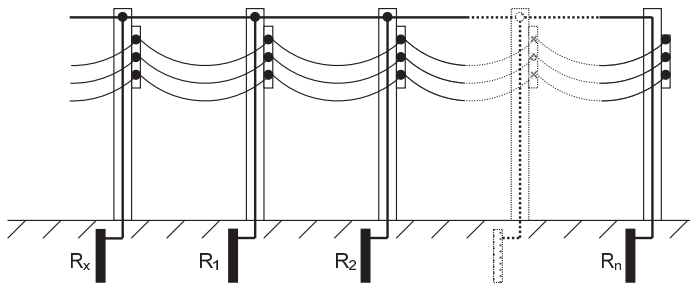

$$R_s = \frac{1}{\sum_{i=1}^n \frac{1}{R_i}}$$

Of these earth resistances,  $R_1, R_2, \dots, R_n$  can be considered that they are connected in parallel. And can be regarded as a combined resistance  $R_s$ . The  $R_s$  can be regarded small enough against  $R_x$  since it is a combined resistance consists of several resistances. So the measured values obtained by using this instrument will be quite small since  $R_s$  values are measured actually. To measure earth resistances of multi-earthed system, a use of our Digital Earth Clamp MODEL4200 is recommended.

**9-1-1 Precise Measurement (3-Wire) \*** with Earth Test Leads MODEL 7229A  
This is a standard method to measure earth resistances. The measured earth resistances are free of auxiliary earth resistances but the resistances on the E terminal are contained.

Terminals to be used : E, S(P), H(C) Terminals  
Test Leads : connect to the E, S(P), H(C) Terminals  
Auxiliary Earth Spike : 2 pcs, connect to the S(P) and H(C) terminal

**(1) Setting of Wiring System**

Select “Wire (3)” with reference to “8-2-2 Setting for Measurement Method” in this manual.

**(2) Setting of Rk**

1. Firmly insert each plug of 3 test leads (green, yellow, red) to the corresponding connectors on the instrument.
2. Select the “ $2\Omega$ ” or “ $20\Omega$ ” Range.
3. Engage 3 Alligator clips to short-circuit all of them.
4. Save the Rk values with reference to “8-2-7 Setting for the residual resistance on the Test Leads”.

**Note) A break in Test Leads or burnout of Fuse is suspected when the LCD shows “Rk=OL  $\Omega$ ” while 3 Test Leads are being shorted.**

**(3) Connection of Auxiliary Earth Spikes and Test Leads**

Stick the Auxiliary Earth Spikes “S(P)” and “H(C)” into the ground deeply. They should be aligned at an interval of 5-10m from the earthed equipment under test. Connect the green Test Lead to the earthed equipment under test, the yellow Test Lead to the Auxiliary Earth Spike “S(P)” and the red Test Lead to the Auxiliary Earth Spike “H(C)”.

(Fig.34)

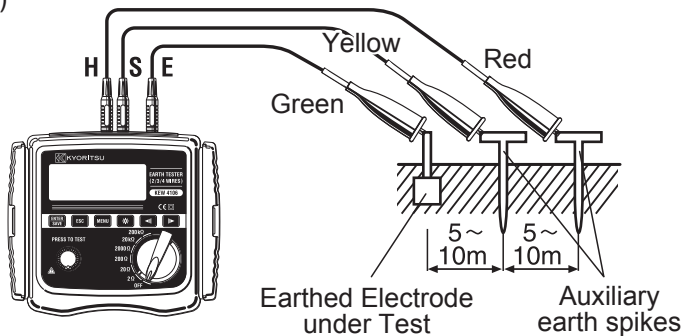
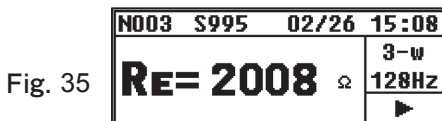



Fig. 34

#### (4) Earth Resistance Measurement

Select a Range (any Range is ok) when the connection is done, and press the TEST Button. A message “ **Measuring...** ” is displayed at the upper right on the LCD. The measured earth resistances “Re” are displayed on the LCD when a measurement is finished. (Fig.35)



Pressing the Cursor Key “  ” displays the Result Display Screen (Fig.36) to view each parameter.

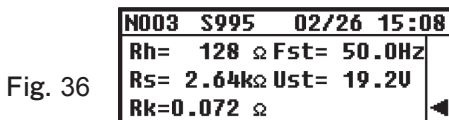

Press the “  ” Key to return to the Main Screen.

**Note)** The readings may not correct when the auxiliary earth resistance is too high. Stick the Auxiliary Earth Spikes S(P) and H(C) in the moist part of the soil. If a message “ **Rh>limit** ” or “ **Rs>limit** ” appear on the LCD, auxiliary earth resistance is too high to make measurements. Recheck the connection of Test Leads.

Give enough water where the spikes have to be stuck into the dry, stony or sandy part of the earth so that it may become moist. In case of concrete, lay the Auxiliary Earth Spike down and water it, or put a wet cloth etc. on the spike when making measurements.

**⚠ DANGER**

The Re measurement cannot be made when a warning message “Voltage High!!” like shown in Fig.37 appear on the LCD. Voltages more than 15V exist between the “E” and “S(P)” terminals.

Fig. 37

N003 S995 02/26 15:08	
<b>RE= --- kΩ</b>	3-w
<b>Voltage High!!</b>	128Hz
	▶

Pressing the “▶” Key shifts the display as shown in Fig.38.

Fig. 38

N003 S995 02/26 15:08	
Re= --- Ω	Fst= 50.0Hz
Rh= --- Ω	Ust= 0L V
Rs= --- Ω	◀

The message “Ust=0L V” means the Ust is more than 50V.

To avoid this, make measurements after reducing the earth voltages by turning off the power supply of the equipment under test etc.

**9-1-2 Precise Measurement (4-Wire) \*with Earth Test Leads MODEL 7229A**

The “ES” Terminal is also used with the other terminals used at the 3-wire Precise measurements. In this case, more precise results can be obtained because auxiliary earth resistances of the measured earth resistances are excluded, moreover, resistance of the Test Leads connected to the E Terminal can be canceled.

Terminals to be used : E, ES, S(P), H(C) Terminals

Test Leads : connect to the E, ES, S(P), H(C) Terminals  
 (the “ES” Test Lead should be connected to the earthed equipment under test where the “E” Test Lead is connected.)

Auxiliary Earth Spike : 2 pcs

(1) Setting of Wiring System

Select “Wire (4)” with reference to “**8-2-2 Setting for Measurement Method**” in this manual.

## (2) Setting of Rk

The measured results obtained at 4-Wire system are not be influenced by the Test Leads Connected to the “E” Terminal, but setting of Rk can be made on this instrument.

1. Firmly insert each plug of 4 Test Leads (green, black, yellow, red), to the corresponding connectors on the instrument.
2. Select the “ $2\Omega$ ” or “ $20\Omega$ ” Range.
3. Engage 4 Alligator clips to short-circuit all of them.
4. Save the Rk values with reference to “8-2-7 Setting for the residual resistance (Rk) on the Test Leads”.

**Note) A break in Test Leads or burnout of Fuse is suspected when the LCD shows “Rk=OL  $\Omega$ ” while 4 Test Leads are being shorted.**

## (3) Connection of Auxiliary Earth Spikes and Test Leads

Stick the Auxiliary Earth Spikes S(P) and H(C) into the ground deeply. They should be aligned at an interval of 5-10m from the earthed equipment under test. Connect the green Test Lead to the earthed equipment under test, the yellow Test Lead to the Auxiliary Earth Spike S(P) and the red Test Lead to the Auxiliary Earth Spike H(C). The black Test Lead connected to the “ES” Terminal should be connected to the earthed equipment under test. (Fig.39)

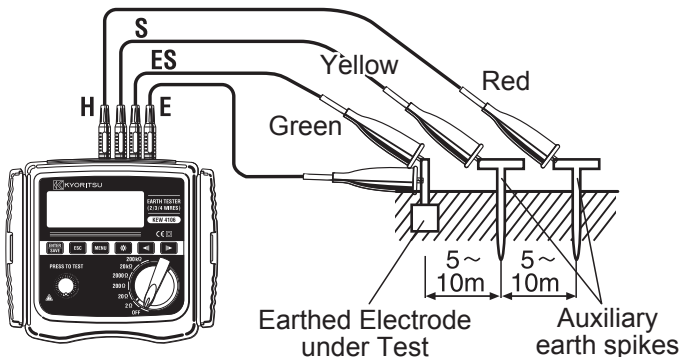

Fig. 39

## (4) Earth Resistance Measurement

Select a Range (any Range is ok) when the connection is done, and press the TEST Button. The measured earth resistances “Re” are displayed on the LCD. The operation procedure is same to that for 3-Wire measurements.



Note) If a message “**Rh>limit**” or “**Rs>limit**” appear on the LCD, auxiliary earth resistance is too high to make measurements.  
Recheck the connection of Test Leads.

### 9-1-3 Simplified Measurement (2-Wire) \*with Simplified Test Probes MODEL 7238A

#### DANGER

- Use a Voltage detector to check the earth of the commercial power supply.
- Do not use the instrument to check the earth of the commercial power supply. A danger will be caused because the voltage may not be displayed when in case of a live conductor when the connection of the earth electrode to be measured has come off, or when the connection of the test leads of the instrument is not correct etc.
- Do not use this instrument to measure the voltage of commercial Power supply. This instrument is not designed to measure voltages of commercial power supply.
- When using the supplied Simplified Test Probes, the “S(P)” and “H(C)” Terminals will be short-circuited and the input impedance will be reduced. The residual current circuit breaker may operate when making measurements of the voltage in the circuit with the breaker.
- ELCBs may trip when performing simplified measurements on the outlet of the circuit with ELCBs since this instrument has large test currents.

Use this method when the Auxiliary Earth Spike cannot be stuck. In this method, an existing Earth Electrode with a low earth resistance, such as a metal water pipe, a common earth of a commercial power supply and an earth terminal of a building, can be used with the 2-Wire method.

However, the measured earth resistances contain the auxiliary earth resistance and the resistance of the “E” Test Lead.

This instrument is supplied with a set of Simplified Measurement Test Leads for which both of Alligator Clips and Flat Test Bar can be replaced and used if necessary.

Terminals to be used : E, S(P), H(C) Terminals

Test Leads : one to the “E” Terminal, Simplified Measurement Probes to the “S” and “H” Terminals and short-circuit these Terminals.

Auxiliary Earth Spike : None is used

### (1) Setting of Wiring System

Select “Wire (2)” with reference to “8-2-2 Setting for Measurement Method” in this manual.

### (2) Setting of Rk

1. Put the Alligator Clips to the 2 Test Leads (green, red), and connect the green Plug to the “E” Terminal and the two red Plugs to the “S(P)” and “H(C)” Terminals respectively.
2. Select the “ $2\Omega$ ” or “ $20\Omega$ ” Range.
3. Engage 2 Alligator clips to short-circuit both of them.
4. Save the Rk values with reference to “8-2-7 Setting for the residual resistance (Rk) on the Test Leads”.

**Note)** A break in Test Leads or burnout of Fuse is suspected when the LCD shows “Rk=OL  $\Omega$ ” while 4 Test Leads are being shorted.

### (3) Connection

Connect the Test Leads as shown in Fig.40.

**Note)** When the supplied Simplified Measurement Probes are not used, the “S(P)” and “H(C)” Terminals should be shorted.

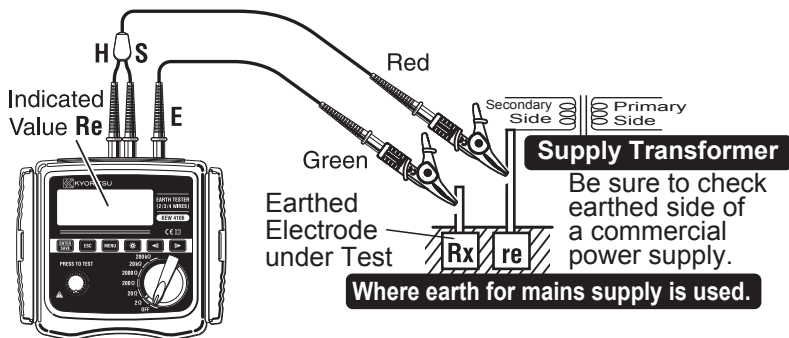

Fig. 40

### (4) Earth Resistance Measurement

Select a high resistance Range when the connection is done, and press the TEST Button. Then the earth resistance values “Re” are displayed on the LCD. Select a lower Range for the low earth resistances.

## (5) Measured resistances at simplified measurements

Two-Wire method is used for the simplified measurements. In this method, earth resistance of the earthed electrode ( $r_e$ ) connected to the “S(P)” Terminal is added to the true earth resistance “ $R_x$ ” and shown as an indicated value “ $R_e$ ”.

$$R_e \text{ (indicated value)} = R_x + r_e$$

If the  $R_e$  is known beforehand, true earth resistance value  $R_x$  is calculated as follows.

$$R_x = R_e - r_e$$

**Note) The “ $r_e$ ” cannot be canceled by the setting of  $R_k$ .**

## 9-2 Earth Resistivity ( $\rho$ ) Measurement

### CAUTION

- The measured results may be influenced by induction if measurements are made with the Test Leads twisted or in touch with each other. When connecting the Probes, they should be separated.

Making a setting of the interval between Auxiliary Earth Spikes first and measuring the earth resistances with the 4 Auxiliary Earth Spikes stuck into the ground at even intervals. Then the instrument can calculate and display earth resistivity on the LCD automatically.

Terminals to be used : E, ES, S(P), H(C) Terminals

Test Leads : connect to the E, ES, S(P) and H(C) Terminals

Auxiliary Earth Spike : 4 pcs

### (1) Setting of Wiring System

Select “Wire ( $\rho$ )” with reference to “8-2-2 Setting for Measurement Method” in this manual.

**Note) The instrument doesn't accept any setting change on “ $R_k$ ” while measuring earth resistivity ( $\rho$ ).**

### (2) Connection of Auxiliary Earth Spikes and Test Leads

Stick the four Auxiliary Earth Spikes into the ground deeply. They should be aligned at an interval of 1-30m. The depth should be 5% or less of the interval between the spikes.

(e.g. The spike should be stuck in the depth of 25cm or less when the interval of the Auxiliary Earth Spikes is 5m.)

If the Spikes stuck too deep, it may result in inaccurate earth resistivity measurement.

**Note) The supplied Test Leads MODEL 7229A can be used for the Spikes stuck at the interval of max 20m.**

**Note) The length of the supplied Auxiliary Earth Spike MODEL 8032 is 20cm.**

Connect the green, black, yellow Test Leads connected to the “E”, “ES”, “S(P)” and “H(C)” Terminals on the instrument to the Auxiliary Earth Spikes from the closest to the farthest in this order. (Fig.41)

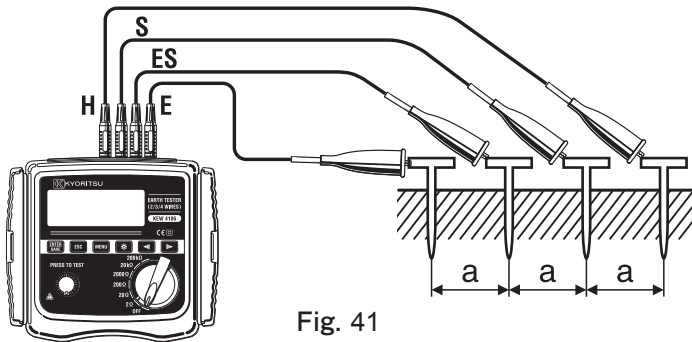

Fig. 41

**(3) Setting of the Interval between Auxiliary Earth Spikes**

The interval of the Spikes should be entered according to the setting made at the step of “8-2-5 Setting for the interval between Auxiliary Earth Spikes at Earth Resistivity ( $\rho$ ) Measurements”.

**(4) Earth Resistivity ( $\rho$ ) Measurement**

Select a Range (any Range is ok) when the connection is done, and press the TEST Button. Then the measured earth resistivity ( $\rho$ ) and the earth resistance “Rg” between the ES-S Terminals are displayed. (Fig.42)

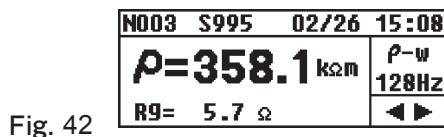



Fig. 42

Pressing the Cursor Key “  ” displays parameters like shown in Fig.43.

N003	S995	02/26	15:08
Rg=	5.88 $\Omega$	Fst=	0.0Hz
Rh=	204 $\Omega$	Ust=	0.0V
Rs=	99 $\Omega$	L=	10.0m

Fig. 43

Press the “  ” Key to return to the Main Screen.

If the “Rg” value is too large, the display reads as shown in Fig.44.

In this case, rotate the Range Switch and select an upper Range.

N003	S995	02/26	15:08
$\rho$ =	OL	$\rho$ -w	
Rg=	OL k $\Omega$	128Hz	

Fig. 44

Pressing the “  ” Key while the measured result of  $\rho$  is being displayed switches the display as indicated in Fig.16. Then setting of interval between auxiliary earth spikes (Lh) can be made. Clause 8-2-5 describes the detailed setting procedure.

Length( $\rho$ )
L= 12.3m

Fig. 16

Note) The depth should be 5% or less of the interval between the spikes.

If the Spikes stuck too deep, it may result in inaccurate earth resistivity measurement.

Note) Accurate earth resistivity measurement will be affected and errors in measured result becomes large if the “Rg” value is smaller than the full-scale value at the selected Range. When the “Rg” and “ $\rho$ ” values vary widely at each Range, measurements should be made again at proper “Rg” Range.

Note) If a message “ **Rh>limit** ” or “ **Rs>limit** ” appear on the LCD, auxiliary earth resistance is too high to make measurements. Recheck the connection of Test Leads.

## 10. Store/ Recall the Measurement Results

Measurement conditions and measured results can be saved in the memory of the instrument. (max 800)

The stored data can be transferred to a PC via an Optical Adaptor Model8212USB by using a special software “KEW Report”.

### 10-1 How to save the data

Press the “” Key when an earth resistance measurement is finished. Then the LCD reads as shown in Fig.45.

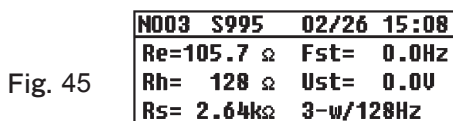

Press the “” Key again, and then “saved” is displayed with highlighted at the lower right of the LCD and the measured values are saved. (Fig.46)

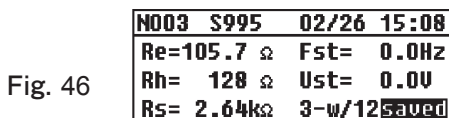

Press the “” Key to return to the Main Screen.

Note) Pressing the TEST Button again initiates another measurement.

Note) Data cannot be saved while the Low Battery Mark is displayed on the LCD.

Note) When the saved data reaches to the max limit of the capacity (800), “Full” is displayed at the upper left on the LCD as shown in Fig.47 and no more data can be saved.

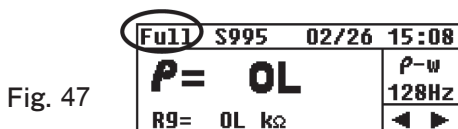

When trying to save data with memory capacity is full, a message shown in Fig.48 is displayed. Press the “” Key and return to the Main Screen.

To save new data, it is necessary to delete the old data first. See “10-3 How to delete the saved data” to delete the saved data in the memory.

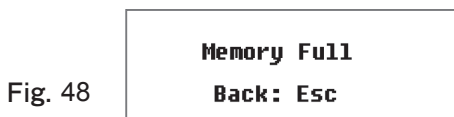

## 10-2 How to recall the saved data

The saved data can be displayed on the LCD according to following sequence.

Press the “” Key on the Main Screen to display the SYSTEM\_MENU Screen. (Fig.49)

Fig. 49

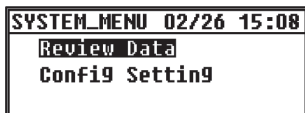



Put the cursor to “Review Data” and press the “” Key to display the Review Screen. (Fig.50) Then the measured data is saved with a Memory No, Site No and date/time information.

Fig. 50

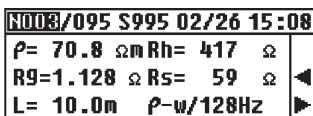

Press the Cursor Keys “” or “” Key and select Data No. Keep a Cursor Key pressed down to alter the number quickly.

**Note) When no data has been saved in the memory, following message is displayed on the LCD. (Fig.51)**

Fig. 51

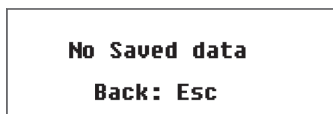

Press the “” Key to return to the Main Screen.

## 10-3 How to delete the saved data

The saved data can be deleted according to following sequence.

### 10-3-1 Delete the data one by one

Press the Cursor Keys “” and “” on the Review Screen (Fig.52) and select the data to be deleted.

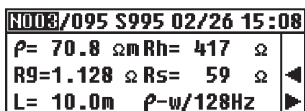

Fig. 52

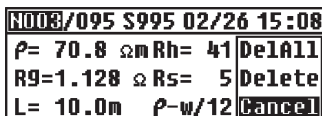

Press the “” Key to delete the selected data. (Fig.53)

Fig. 53



Pressing the “” or “” Key while the cursor is on the “Cancel” returns to the Review Screen without deleting data.

Put a cursor to “Delete” and press the “” Key. (Fig.54) Then a confirmation message is displayed on the LCD. (Fig.55)

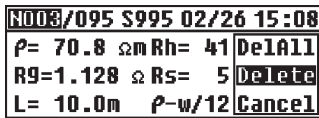

Fig. 54

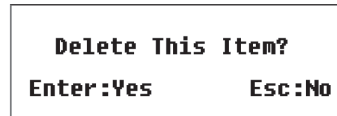



Fig. 55

Press the “” Key to return to the Review Screen without deleting data while a message shown in Fig.55 is displayed on the LCD. Press the “” Key to delete the selected data. Then the Review Screen is displayed with the next data.

Note) Number of the saved data is decreased after deleting some data, but the Data No will not be changed. So the last Memory No. may become bigger than the No. showing the number of the saved data in the memory. (Fig.56) Future data will be saved with the empty Memory No. automatically and the existing data will not be overwritten.

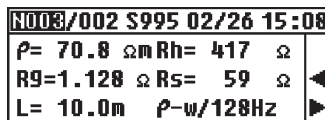



Fig. 56

### 10-3-2 Delete the whole data one-time

Press the “” Key at the Review Screen, and select “Del All” with the Cursor Keys. Then press the “” Key again. (Fig.57)

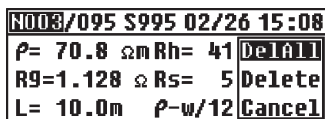

Fig. 57

Then a confirmation message is displayed on the LCD. (Fig.58)

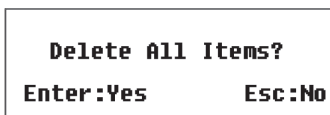

Fig. 58







Press the “  ” Key to return to the Review Screen without deleting data. Press the “  ” Key to delete the whole data. Then a following message is displayed on the LCD. (Fig.59)

Fig. 59

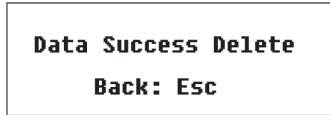

Pressing the “  ” Key returns to the SYSTEM\_MENU Screen. Another press of the “  ” Key returns to the Main Screen. Memory No. is restored to “N001”.

#### 10-4 How to transfer the stored data to a PC

The stored data can be transferred according to following sequence. The special software “KEW Report” should be installed beforehand.

- (1) Connect Model 8212 USB to the USB terminal of a PC.
- (2) Disconnect the Test Leads from the instrument, and connect Model 8212 USB as shown in Fig.60.

Fig. 60

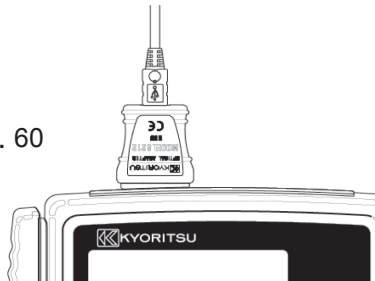

- (3) Power on the instrument while setting the Range Switch to any position.
- (4) Start the special software “KEW Report” on your PC, and then click “Download” command. The data in the instrument will be transferred to your PC. For further details, please refer to the instruction manual for Model8212 USB and the HELP of KEW Report.

---

## 11. Battery and Fuse Replacement

---

**⚠ DANGER**

- Never attempt to replace batteries while making measurements.  
When replacing the Fuse, use the one with same specification.

**⚠ WARNING**

- To avoid electrical shock hazard, disconnect the Test Leads from the instrument before opening the Battery Compartment Cover. Screw and fasten the Cover when a replacement work completes.

**⚠ CAUTION**

- Do not mix new and old batteries.  
Install batteries in the orientation as shown inside the Battery Compartment, observing correct polarity.
- When disposing the old batteries, please follow your local regulations.

### 11-1 Battery Replacement

1. Set the Range Switch to the “OFF” position, and disconnect the Test Leads from the instrument.
2. Unscrew the Battery-Compartment-fixing screws, and remove the Cover and replace the batteries with new ones. Replace all 8 batteries.
3. Fix the Cover after replacing batteries and screw up the Cover.

### 11-2 Fuse Replacement

1. Set the Range Switch to the “OFF” position, and disconnect the Test Leads from the instrument.
2. Unscrew the Battery-Compartment-fixing screws, and remove the Cover.  
Replace the fuse with new one. (Fig.61)  
Fuse Spec : F500mA/ 600V, dia. 6.35 x 32mm.
3. Fix the Cover after replacing a fuse and screw up the Cover.

Fig. 61

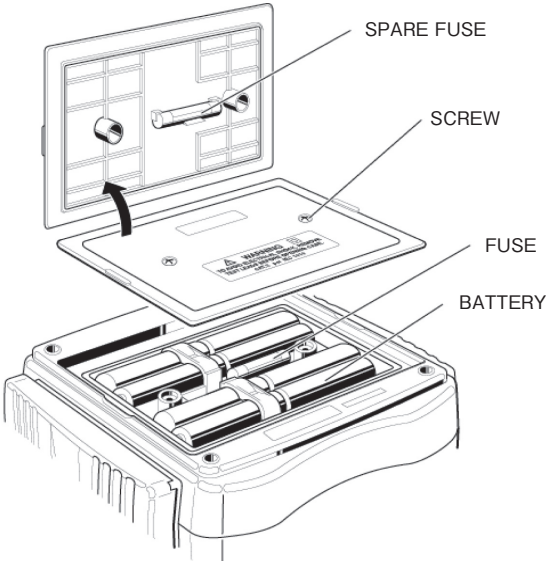

---

## 12. Case and Shoulder strap Assembly

---

By hanging the instrument around the neck, both hands will be let free for testing.

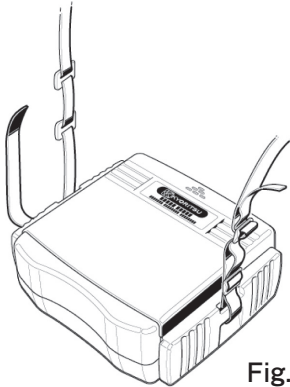

Fig. 62

Pass the Shoulder strap down through the buckle from the top. (Fig.62)

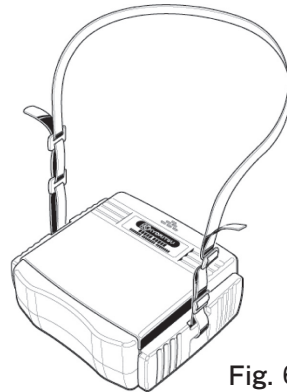

Fig. 63

Adjust the strap for length and secure. (Fig.63)

## 13. Before Sending for Service

If this instrument should fail to operate correctly, return it to your nearest Distributor stating the exact nature of the fault. Before returning the instrument, follow the trouble-shooting guide shown below.

- Instrument doesn't power on  
Open the Battery Compartment Cover at the backside of the instrument, and check whether batteries are missing or they are installed in correct polarity. (Refer to "11. Battery and Fuse Replacement") Batteries are not installed in the instrument at the time of shipment.
- Incapable of setting "Rk" (Fig.64, 65)



Fig. 64



Fig. 65

Selectable "Rk" values at 2Ω and 20Ω Ranges are up to 9Ω. Are the Test Leads short-circuited? A break in Test Leads or burnout of Fuse is suspected when the LCD reads "OL" while the connection is correct and the cords are shorted.



Fig. 66

Rk setting is available at 20Ω or lower Ranges. (Fig.66)

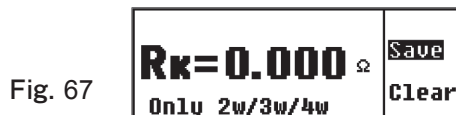

Fig. 67

Rk cannot be set when measuring earth resistivity. (Fig.67)  
(Refer to "8-2-7 Setting for the residual resistance (Rk) on the Test Leads").

- Incapable of measuring earth resistance



Voltages of 20V or more are being applied between the “E “ and “S(P)” Terminals. (Fig.68)



The upper limit of the measuring range may be exceeded. (Fig.69)  
Select an upper Range.

The Test Leads may be loose. (Fig.69)

Check the connections again.

- Marks shown in Fig.70 and 71 are displayed at Re measurements



Fig. 70



Fig. 71

The Rh or Rs value is more than  $(500+Re \times 100)\Omega$  or  $50k\Omega$  or more; it results in inaccurate measurement. Check the condition of the Earth Spikes stuck into the ground. (Refer to “9-1 Earth Resistance Measurement”)

- The LCD reads “ $\rho=OL$ ” or “Rg =OL” at earth resistivity measurements.  
Re measurements. (Fig.72)

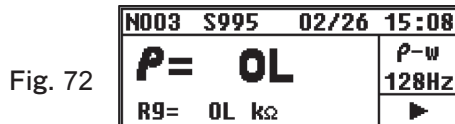

The Rg value exceeds the upper limit of the Range. Select an upper Range and test again. At earth resistivity measurements, the display reads “OL” when the intervals between the spikes become longer although a proper Range is selected. Max indication of the earth resistivity value is “1999k $\Omega$ ”. (Refer to Measuring range and tolerance described at “4. Specification” and “9-2. Earth Resistivity ( $\rho$ ) Measurement”.)

- Incapable of saving data

The LCD reads as shown in Fig.73.

Fig. 73

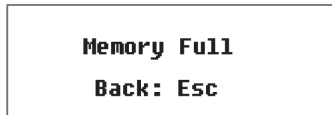

The memory capacity is full. (800 data) To save new data, old data should be deleted first. (See “**10. Save/ Recall the Measurement Results**”)

- Incapable of transferring data to PC

Instrument is powered on?

MODEL 8212 USB Cable and the PC are connected properly?

MODEL 8212 USB Cable is properly connected to the Communication Connector of the instrument?

Data transfer will be interfered if the Infrared Communication Terminal is dirt; clean the Terminal with a clean cotton swab.

**DISTRIBUTOR**

Kyoritsu reserves the rights to change specifications or designs described in this manual without notice and without obligations.



**KYORITSU ELECTRICAL  
INSTRUMENTS  
WORKS, LTD.**

No.5-20,Nakane 2-chome, Meguro-ku,  
Tokyo, 152-0031 Japan

Phone: +81-3-3723-0131

Fax: +81-3-3723-0152

Factory: Ehime

**[www.kew-ltd.co.jp](http://www.kew-ltd.co.jp)**