

## Tools required:

- Phillips-head screwdriver for installing the water level sensor (RX2103 and RX2104 models) or mounting the station to a flat surface with screws.
- A ½ inch box wrench if you are using U-bolts to mount the station to a tripod or mast.
- Other tools may be required depending on the accessories you are using for your station deployment.

## 1 Log in to HOBOLink.

Go to [www.hobolink.com](http://www.hobolink.com) and log in to an existing account or create a new one. You'll receive an email to activate the account.

## 2 Register the station.

In HOBOLink, click Devices, then RX Devices. Click the Register a Device link. Give the station a name and enter the serial number and device key from the label inside the station door.

**Note:** If you are using your own micro SIM card, follow the instructions at [www.onsetcomp.com/support/manuals/23845-installing-micro-sim-rx2100-station](http://www.onsetcomp.com/support/manuals/23845-installing-micro-sim-rx2100-station) before continuing.

## 3 Mount the station.

There are three ways to mount the station using the built-in mounting tabs. **Note:** You can also defer mounting until the end of the process if you want to perform initial testing.

- Use the two sets of outer holes and 1-5/8 inch saddle-clamp U-bolts to attach the logger to a tripod or mast (this is the recommended method for mounting on a mast). Do not use U-bolts without the saddle clamps as that could bend the mounting tabs and damage the housing or compromise the weatherproof seal. The flat portion of the saddle clamps should be against the mounting tabs.
- Use the included cable ties with the two sets of inner holes to affix the logger to a PVC pipe or mast.
- Use the included screws and washers with the two sets of outer holes to adhere the logger to a wall or flat surface.

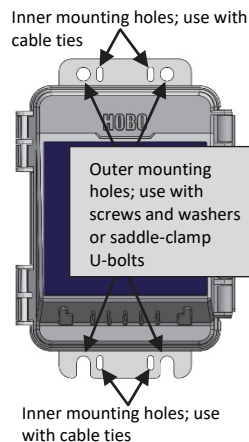

**Important:** See the RX2100 manual for additional deployment guidelines at [www.onsetcomp.com/support/manuals/23808-rx2100-manual](http://www.onsetcomp.com/support/manuals/23808-rx2100-manual).

## 4 Remove the cable channel.

Remove the cable channel making note of how it is oriented.

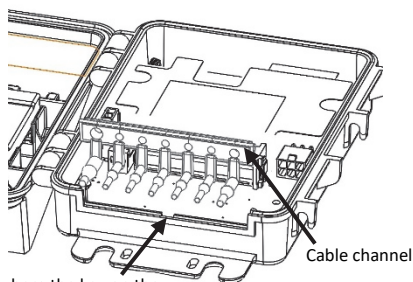

Notch where the key on the bottom of the cable channel is installed

## 5 Install the water level sensor if applicable (RX2103 and RX2104 models).

- Insert the water level sensor cable jack into the water level sensor. Screw on locking nut (hand tight).

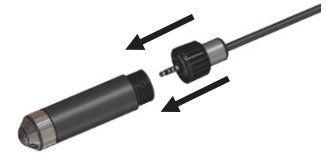

**Important:** Make sure the O-rings on the cable jack end and the cable and sensor mating housing surfaces are clear of any debris. Any contamination of these surfaces can cause leaks that may lead to sensor failure.

- Plug the other end of the water level sensor cable into the port on the right side of the board.

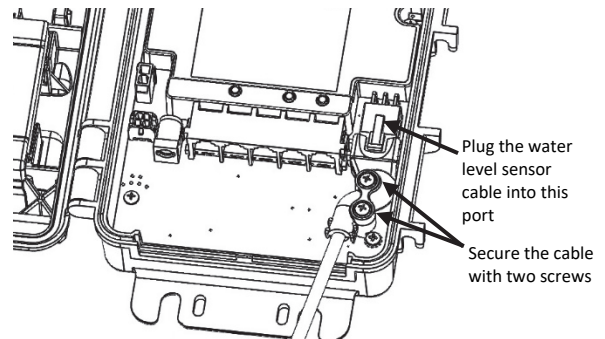

- Use a Phillips head screwdriver to secure the water level sensor cable in place with the two screws provided.
- Route the cable through the far-right hole in the cable channel.

## 6 Plug in smart sensors if applicable.

- Plug in smart sensors into the ports below the LCD.

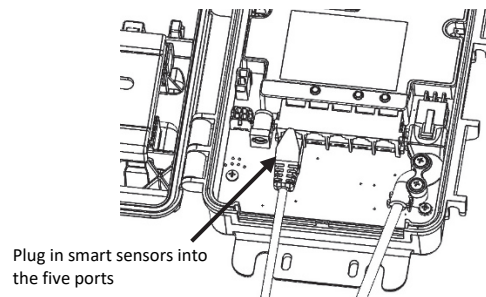

- Route the cables through the holes in the cable channel. There are slits in the cable channel above each hole to guide the cable into the hole. You may need to slightly bend the ends of the channel to reveal the slits and push each cable into the hole that lines up with the corresponding sensor connector.

## 7 Grease and reinstall the cable channel.

- Use the integrated plugs to fill any unused holes. Bend the plugs up to push them into the holes. Once a plug is partially pushed through, you can pull on the part of the plug that is inside the case. You may need to bend the ends of the channel slightly to widen the holes for installing the plugs.
- Lightly coat the portion of the sensor cables that will be in the cable channel with a small amount of silicone grease (about the size of a pea).
- Lightly coat the bottom and two sides of the cable channel with silicone grease.
- Reinstall the cable channel in the station making sure the key on the bottom is inserted in the notch in the station enclosure as pointed out in step 4.

## 8 Plug in the battery and wait for the station to connect to HOBOLink.

**Note for RX2103 and RX2104 models:** If you are using the water level sensor, make sure it is plugged in before powering up the station in this step. Otherwise, only barometric pressure will be logged.

- a. Plug in the battery cable. For RX2102 and RX2104 models, plug in the solar panel cable for the built-in solar panel.

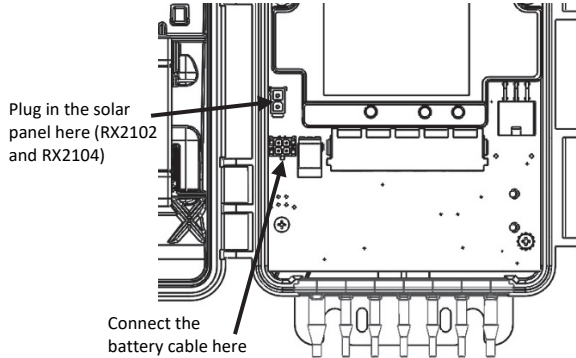

- b. Once the battery cable is plugged in, "Initializing System" will flash on the LCD. A checkmark appears next to "System" after the station initialization is complete.
- c. After the station powers up, it will connect to HOBOLink automatically within two minutes. The cellular icon and "Connection" will flash while the connection is underway. Once the connection is complete, a checkmark appears next to Last Connection. Note that the entire initialization process may take several minutes; wait until Last Connection and the checkmark appears before continuing to step 9.

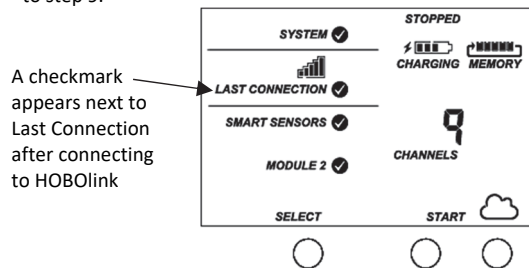

## 9 Configure the station in HOBOLink.

In HOBOLink, click Devices, then RX Devices, and click the icon next to your station. Make changes and click Save on each screen as you configure the following:

- General system settings (nickname, time zone, and image)
- Readout settings (connection interval and night mode)
- Smart sensor logging and sampling interval
- Settings for each smart sensor (e.g. labels, graph, and scaling)

**Important for RX2103 and RX2104 models:** Do not configure the water level and water flow channels yet. Set the logging and sampling interval for the water level sensors module and optionally add labels, scaling, or enable graphing. Continue to step 10 to start logging and then obtain a water reference level reading in step 11 before configuring water level and water flow.

## 10 Start Logging.

Press the Start button on the station to start logging. The station will connect to HOBOLink and then logging will begin.

If you are not using a water level sensor, then the setup is complete. Measurements are uploaded to HOBOLink each time the device connects. Go to [www.hobolink.com](http://www.hobolink.com) and click Help for details on checking the latest conditions, setting up dashboards, exporting data, and more.

## 11 Obtain a reference water level reading (RX2103 and RX2104 models).

Make sure the water level sensor is deployed in its final location and that the station is logging. Take a reference level reading, measuring the water level from the desired reference point.

**Important:** Note the reference level reading as well as the date and time it was taken.

## 12 Configure water level, water flow channels in HOBOLink (RX2103 and RX2104 models).

Perform the following steps in the field in HOBOLink with a mobile device to verify that the system is logging the water level correctly while you are still at the station site.

- a. In HOBOLink, click Devices, then RX Devices, and click the icon next to your station.
- b. Under the water level sensors module in the Configuration menu, select Water Level.
- c. Click the checkbox to Enable Channel.
- d. Click the checkbox to Enable Graph. Type a label (optional).
- e. Enter the reference water level and date and time noted in step 11.
- If the water level surface is **below** the reference point, enter the reference water level as a negative number.
  - If the water level surface is **above** the reference point, enter the reference water level as a positive number.
- f. Select the appropriate water density.
- g. Click Save.

**If you are configuring water flow and using one of the supported weir or flume types, follow steps h–l.**

- h. Select Water Flow from the Configuration menu.
- i. Click the checkbox to Enable Channel.
- j. Click the checkbox to Enable Graph. Type a label (optional).
- k. Choose the measurement method for water flow and enter the appropriate information for the method selected.
- l. Click Save.

Water level and flow data will be calculated starting with the next connection to HOBOLink. If you don't want to wait for the next scheduled connection, press the Cloud button on the station LCD to connect to HOBOLink immediately. Note that the reference water level information entered in this step will not affect any previously logged data.

Go to [www.hobolink.com](http://www.hobolink.com) and click Help for details on checking the latest conditions, setting up dashboards, exporting data, and more.



**For additional information:** See the HOBOLink Station Manual for specifications and detailed operation, including deployment and mounting guidelines, and more information on water level sensor configuration. Go to [www.onsetcomp.com/support/manuals/23808-rx2100-manual](http://www.onsetcomp.com/support/manuals/23808-rx2100-manual) or scan the code at left.