

GH series

INSTRUCTION MANUAL

Analytical Balance

GH-120

GH-200

GH-300

GH-202

GH-252

A&D

A&D Company, Limited

© 2019 A&D Company Ltd. All rights reserved.

No part of this publication may be reproduced, transmitted, transcribed, or translated into any language in any form by any means without the written permission of A&D Company Ltd.

The contents of this manual and the specifications of the instrument covered by this manual are subject to change for improvement without notice.

Windows, Word and Excel are registered trademarks of the Microsoft Corporation.

Contents

Basic Operation

1.	Introduction	3
1.1.	About This Manual.....	3
1.2.	Features.....	4
1.3.	Compliance.....	4
2.	Unpacking the Balance	6
2.1.	Installing the Balance	7
3.	Precautions	9
3.1.	Before Use.....	9
3.2.	During Use.....	9
3.3.	After Use.....	11
3.4.	Power Supply.....	11
4.	Display Symbols and Key Operation	12
5.	Weighing Units.....	13
5.1.	Units	13
5.2.	Changing the Units	16
6.	Weighing	18
6.1.	Basic Operation (Gram Mode).....	18
6.2.	Dual Range.....	19
6.3.	Counting Mode (PCS).....	20
6.4.	Percent Mode (%)	22

Adapting To The Environment

7.	Response Adjustment	23
7.1.	Automatic Response Adjustment.....	23
7.2.	Manual Response Adjustment.....	24
8.	Calibration	25
8.1.	Calibration Group	25
8.2.	Automatic Self Calibration	26
8.3.	One-Touch Calibration.....	26
8.4.	Calibration Test Using the Internal Mass	27
8.5.	Calibration Using an External Weight	28
8.6.	Calibration Test Using an External Weight	29
8.7.	Correcting the Internal Mass Value.....	30
9.	Function Switch and Initialization	31
9.1.	Permit or Inhibit.....	31
9.2.	Initializing the Balance.....	32

Selecting Functions

10.	Function Table.....	33
10.1.	Setting the Function Table.....	36
10.2.	Details of the Function Table	36
10.3.	Description of the Class "Environment, Display"	39
10.4.	Description of the Item "Data Output Mode".....	40
10.5.	Description of the Item "Data Format"	41
10.6.	Data Format Examples	44

10.7.	Clock and Calendar Function.....	46
11.	ID Number and GLP Report.....	48
11.1.	Setting the ID Number.....	48
11.2.	GLP Report.....	49
12.	Data Memory.....	54
12.1.	Notes on Using Data Memory.....	54
12.2.	Data Memory for Weighing Data.....	55
12.3.	Data Memory for Calibration and Calibration Test.....	58
13.	Underhook.....	59
14.	Density Measurement.....	60
Interface And Communication		
15.	Standard Input and Output Interface.....	63
15.1.	RS-232C Interface.....	63
15.2.	Connection to Peripheral Equipment.....	64
15.3.	Commands.....	67
Maintenance		
16.	Maintenance.....	73
16.1.	Treatment of The Balance.....	73
16.2.	Error Codes.....	73
16.3.	Other Display.....	75
16.4.	Checking the Balance Performance and Environment.....	76
16.5.	Asking for Repair.....	76
17.	Specifications.....	77
17.1.	External Dimensions.....	78
17.2.	Options and Peripheral Equipment.....	79
18.	Terms/Index.....	83
18.1.	Terms.....	83
18.2.	Index.....	84

1. Introduction

This manual describes how the balances of GH series work and how to get the most out of them in terms of performance. Read this manual thoroughly before using the balance and keep it at hand for future reference.

1.1. About This Manual

This manual consists of the following five parts:

Basic operation Describes precautions, the balance's construction and basic operation.

Adapting to the environment Describes response (and stability) adjustment to adapt to the environment where there is vibration or drafts, the way to maintain weighing precision in a variation of ambient temperature, calibration and calibration test.

Selecting functions Describes functions of the balance.

Interface and communication ... Describes the serial interface used for communicating with a computer that requests weighing data and controls the balance, and for use with a printer

Maintenance Describes maintenance, error codes, troubleshooting, specifications and options.

1.2. Features

- Automatic self calibration, using the internal mass, adapting to changes in temperature.
- Response adjustment adapting to drafts and/or vibration automatically.
- Memory function to store weighing data and calibration data.
When weighing data is stored only, 200 data can be stored in maximum.
Interval memory mode to store the weighing data periodically.
- Good laboratory practice (GLP) / Good manufacturing practice (GMP) data can be output using the RS-232C serial interface.
- A built-in clock and calendar that can add the time and date to the output data.
- Underhook, for measuring density and weighing magnetic materials.
- Multiple weighing units with most of the common units used around the world.
- Density mode for calculating the density of a solid.
- Standard RS-232C serial interface to communicate with a computer.
Windows communication tools software (WinCT) to allow easy communication with a computer using Windows.
The current version of the WinCT can be downloaded from the A&D website.
- When multiple balances have the GH-08 Ethernet interface installed and are connected to a LAN, data can be acquired from them using the WinCT-Plus software.

1.3. Compliance

1.3.1. Compliance With FCC Rules

Please note that this equipment generates, uses and can radiate radio frequency energy. This equipment has been tested and has been found to comply with the limits of a Class A computing device pursuant to Subpart J of Part 15 of FCC rules. These rules are designed to provide reasonable protection against interference when equipment is operated in a commercial environment. If this unit is operated in a residential area, it may cause some interference and under these circumstances the user would be required to take, at his own expense, whatever measures are necessary to eliminate the interference.

(FCC = Federal Communications Commission in the U.S.A.)

1.3.2. Compliance With Directives of CE mark

CE This device features radio interference suppression, safety regulation and restriction of Hazardous Substances in compliance with the following Council Directives

Council directive 2014/30/EU	EN61326	EMC directive
Council directive 2014/35/EU	EN60950	Safety of Information Technology Equipment
Council directive 2011/65/EU	EN50581	Restriction of the use of certain Hazardous Substances

- The CE mark is an official mandatory European marking.
Please note that any electronic product must comply with local laws and regulations when sold or used anywhere outside Europe.



A & D Instruments Ltd. hereby declare that the following Weighing product conforms to the requirements of the council directives on ...

**Electromagnetic Compatibility (EMC) 2014/30/EU,
Low Voltage Equipment (LVD) 2014/35/EU and
Restriction of the use of certain Hazardous Substances (RoHS) 2011/65/EU**

provided that they bear the CE mark of conformity.

Model/Series...GH Series

Standards applicable:

EN 61326-1:2013

Electrical equipment for measurement, control and laboratory use -EMC requirements Part 1: General requirements

EN 60950-1:2006+A11:2009+A1:2010.A11:2012

Safety of Information Technology Equipment

EN 50581:2012

Technical documentation for the assessment of electrical and electronic products with respect to the restriction of hazardous substances

CE Mark first applied 27 October 2007

Signed for A&D Instruments in Oxford England 01 July 2016

J. Ghuman
Managing Director

2. Unpacking the Balance

Unpack the balance carefully. Keep the packing material to be used for transporting the balance in the future. See the illustrations to confirm that everything is included.

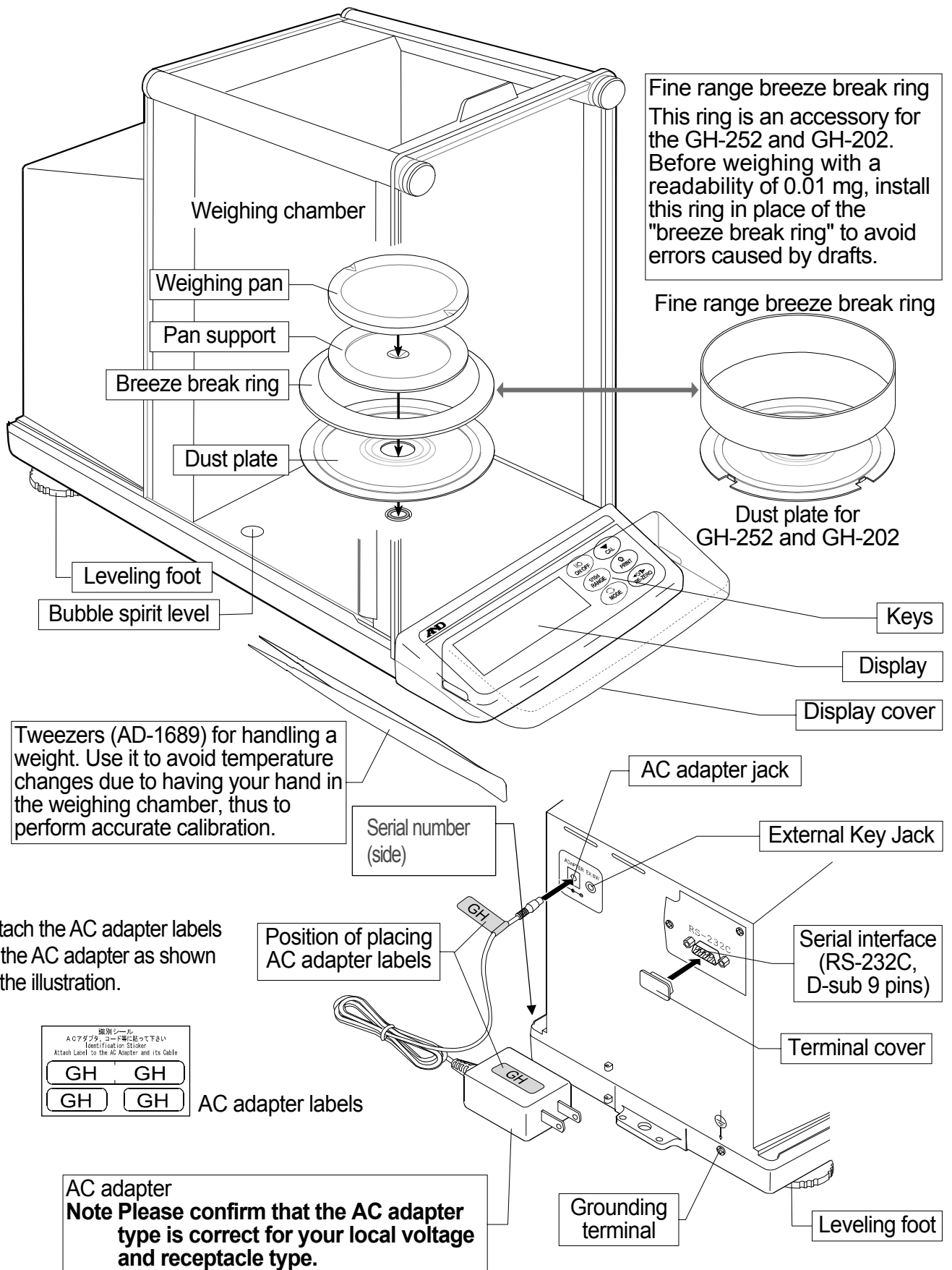

2.1. Installing the Balance

Install the balance as follows:

- 1 Consider the section "3. Precautions " for installing your balance. Place the balance on a firm weighing table.
- 2 Assemble the weighing pan and other parts in accordance with the model and use as shown below.

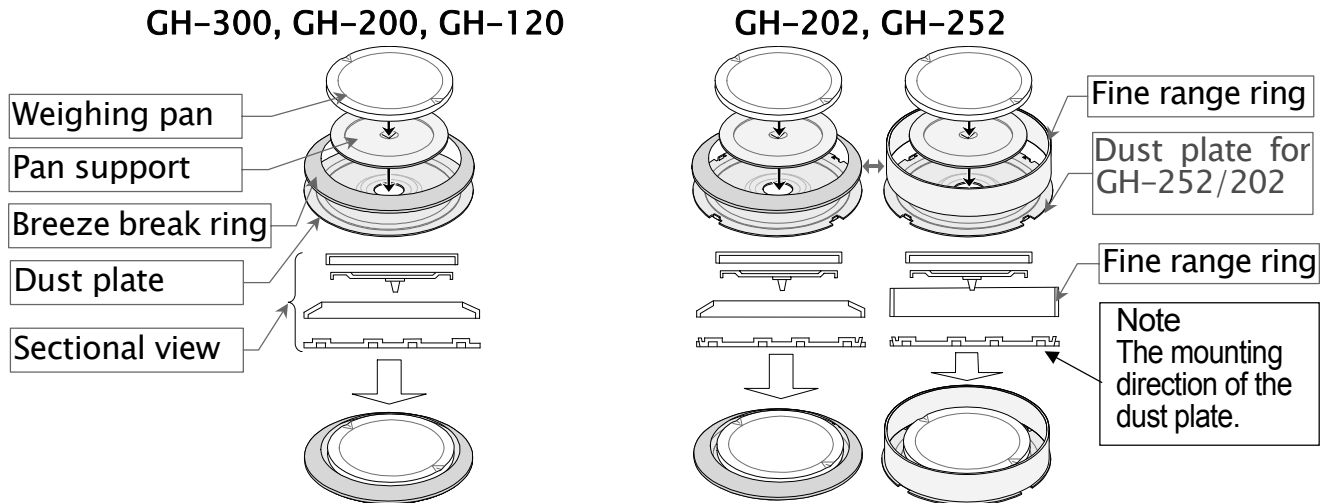

Use the fine range ring in place of the breeze break ring to avoid errors caused by drafts when weighing with a readability of 0.01 mg.

- 3 Refer to "2. Unpacking the Balance" on the previous page to assemble the dust plate and breeze break ring, or fine range ring, pan support and weighing pan in the weighing chamber.
- 4 Adjust the level of the balance using the leveling feet. Ground the balance chassis for discharging static electricity if you have a static problem.
- 5 Please confirm that the adapter type is correct for your local voltage and power receptacle type.
- 6 Connect the AC adapter to the balance. Warm up the balance for at least one hour with nothing on the weighing pan.
- 6 Calibrate the balance before use. Refer to "8. Calibration".

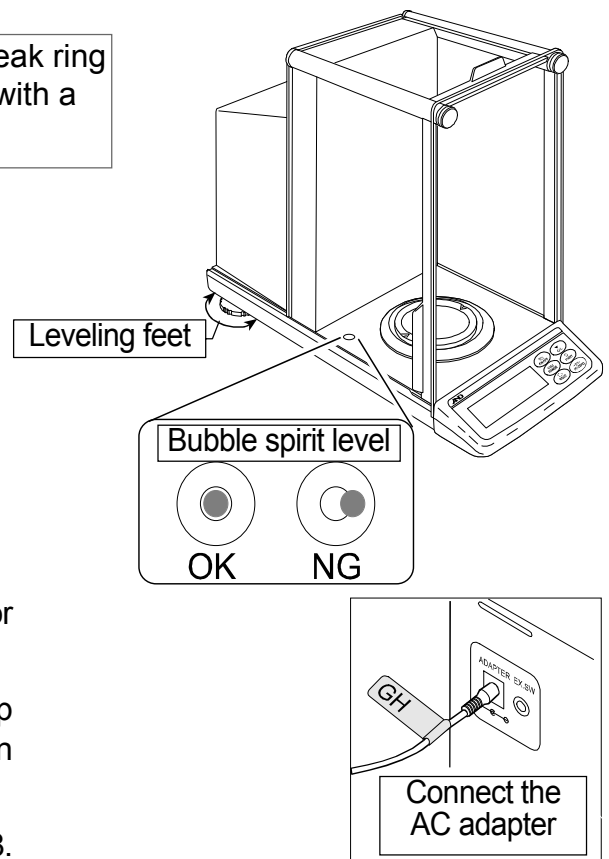

Notes

- Please use the dedicated AC adapter specified for the balance.
- Do not use the AC adapter provided with the balance for other models or equipment with which the AC adapter may not be compatible.
- If you use the wrong AC adapter, the balance and other equipment may not operate properly.

Adjusting the level

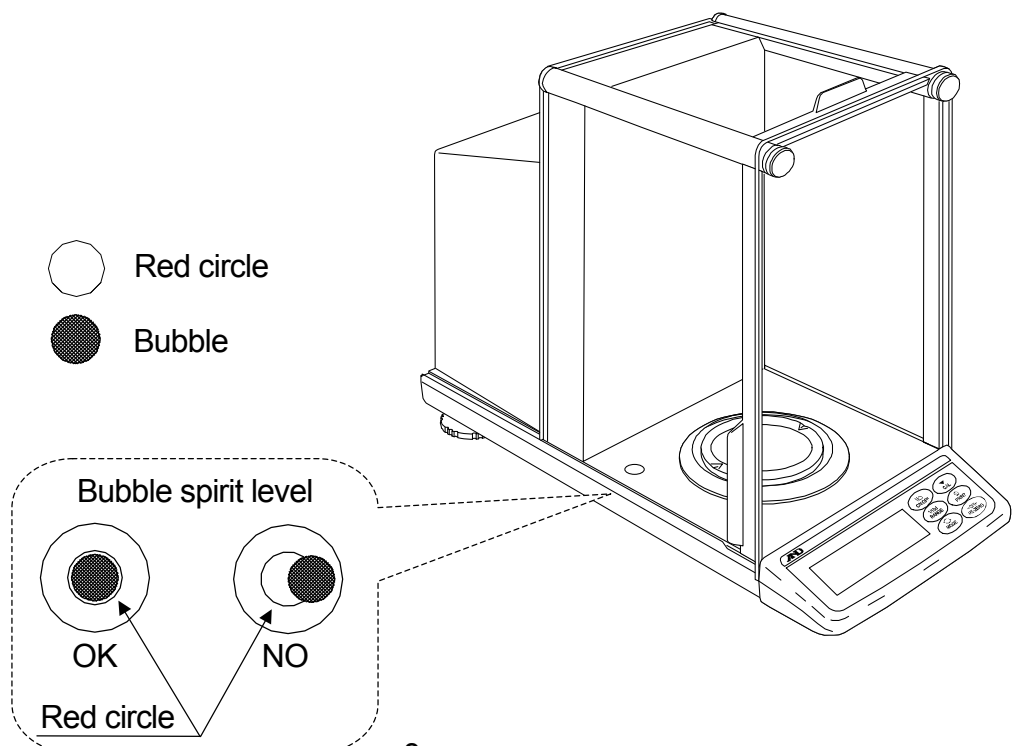
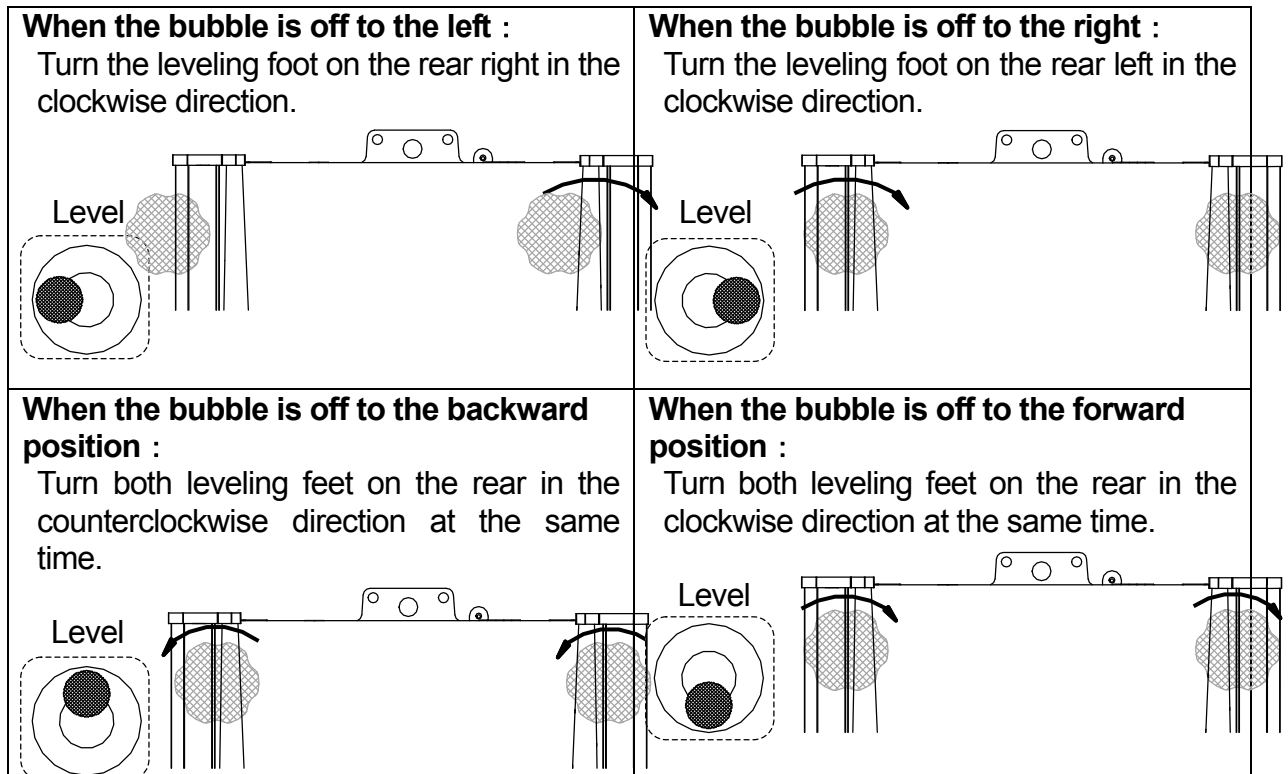

3. Precautions

3.1. Before Use

To ensure that you get the most from your balance, please try to follow these conditions as closely as possible.

- Please confirm that the AC adapter type is correct for your local voltage and receptacle type.
- Ensure a stable power source when using the AC adapter.
- The best operating temperature is about 20°C / 68°F at about 50% Relative Humidity.
- The weighing room should be free of dust.
- The weighing table should be solid and free from vibration, drafts (such as frequently opening doors or windows) and as level as possible.
- Corners of rooms are best as they are less prone to vibration.
- Do not install the balance near a heater or air conditioner.
- Do not install the balance in direct sunlight.
- Do not use the balance near other equipment which produces magnetic fields.
- Adjust the level of the balance using the leveling feet.
- Please warm-up the balance for at least one hour. Plug-in the AC adapter as usual.
- Calibrate the balance before using and after moving it to another location.

⚠ Do not place or use the balance where there is flammable or corrosive gas present.

3.2. During Use

Note the following items to get accurate weighing data.

- Discharge static electricity from the weighing material. When weighing sample (plastics, insulator, etc.) could have a static charge, the weight value is influenced. Ground the balance, and
 - Eliminate the static electricity using the optional AD-1683.
 - Try to keep the ambient humidity above 45%RH at the room.
 - Use a metal shield case.
 - Wipe a charged material (plastic sample etc.) with a damp cloth.
- This balance uses a strong magnet as part of the balance assembly, so please use caution when weighing magnetic materials. If there is a problem, use the underhook (on the bottom of the balance) to suspend the material away from the influence of the magnet.
- Eliminate temperature differences between the weighed sample and the environment. When a sample is warmer (cooler) than the ambient temperature, the sample will appear lighter (heavier) than the true mass. This error is due to the rising (falling) draft next the sample. If you touch the sample, the same type error will occur.

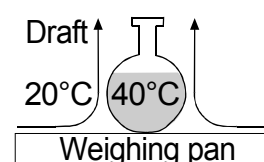
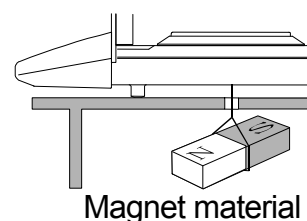
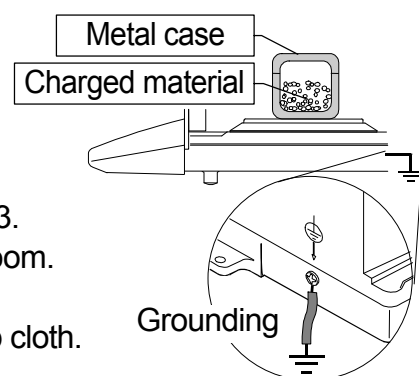

Do not touch the sample directly with your hand. Use tweezers or other tools.

- Make each weighing gently and quickly to avoid errors due to changes in the environmental conditions.

- Before weighing with a readability of 0.01 mg for the GH-252 and GH-202, the "fine range breeze break ring" can be installed in place of the "breeze break ring" to avoid errors caused by drafts.

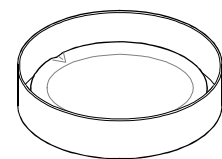

Fine range breeze break ring

- Do not drop things upon the weighing pan, or place a weight beyond the range of the balance on the weighing pan.

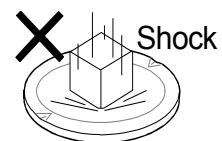

- Do not use a sharp instrument (such as a pencil or ball point pen) to press the keys, use your finger only.

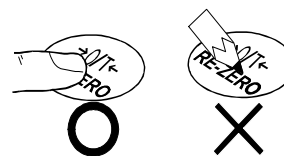

- Press the RE-ZERO key before each weighing to prevent possible errors.

- Calibrate the balance periodically so as to eliminate possible errors.

- Take into consideration the affect of air buoyancy on a sample when more accuracy is required.

- Avoid foreign matter (dust, liquid or metal fragments) that could get inside the balance.

- Operate your balance gently. Shorten the operation time as much as possible (Opening and closing door, putting and removing sample). Use a pair of tweezers (pincette) to avoid temperature changes due to heat from inserting your hand into the weighing chamber.

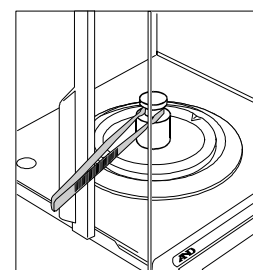

3.3. After Use

- Avoid mechanical shock to your balance.
- Do not disassemble the balance. Contact your local A&D dealer if your balance needs service or repair.
- Do not use solvents to clean the balance. For best cleaning, wipe with a dry lint free cloth or a lint free cloth that is moistened with warm water and a mild detergent.
- Avoid foreign matter (dust, liquid or metal fragments) that could get inside the balance.

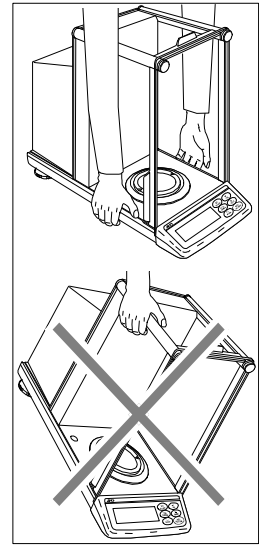

3.4. Power Supply

- Do not remove the AC adapter while the internal mass is in motion, for example, right after the AC adapter is connected, or during calibration using the internal mass. If the AC adapter is removed under the conditions described above, the internal mass will be left unsecured, that may cause mechanical damage when the balance is moved. Before removing the AC adapter, press the **ON:OFF** key and confirm that zero is displayed in weighing mode.
- When the AC adapter is connected, the balance is in the standby mode if the standby indicator is on. This is a normal state and does not harm the balance. For accurate weighing, we recommend that you always plug in your balance so it can warm up.

4. Display Symbols and Key Operation

Display

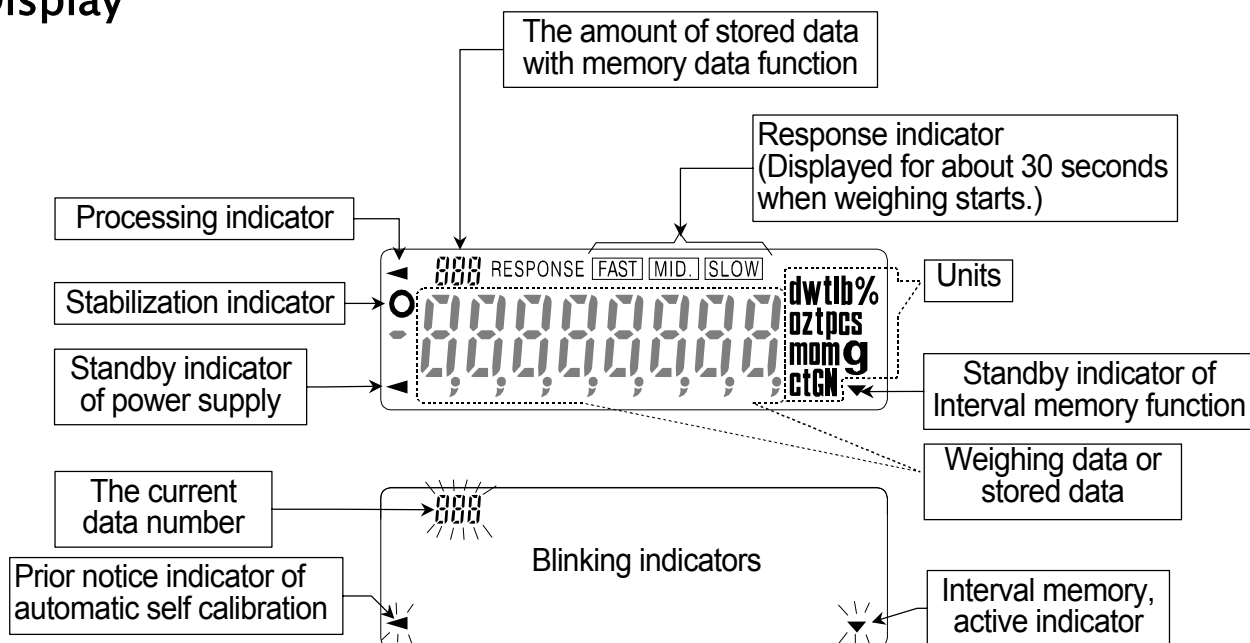

Key operation

- Press and release the key immediately" or "Click the key"
- Press and hold the key (for approx. 2 seconds)

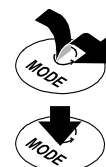

Key	When pressed and released	When pressed and held (for approx. 2 seconds)
	The key to turn the display ON and OFF. The standby indicator is displayed when the display is turned off. The weighing mode is enabled when the display is turned on. This key is available anytime. Pressing the key during operation will interrupt the operation and turn the display OFF.	
	<ul style="list-style-type: none"> □ In the weighing mode, the key to turn the readability ON and OFF. □ In the counting or percent mode, the key to enter the sampling mode. 	The key to enter the function table mode. Refer to "10. Function Table".
	The key to switch the preset weighing units stored in the function table. Refer to "5. Weighing Units".	The key to perform automatic response adjustment.
	The key to perform calibration using the internal mass.	The key to display other items of the calibration menu.
	The key to outputs the weighing data to a printer or personal computer (or store it in memory) depending on the function table settings. (Factory setting = output)	No function. (factory setting) By changing the function table: <ul style="list-style-type: none"> □ "Title block" and "End block" for GLP/GMP report are output. □ The data memory menu is displayed.
	The key to set the display to zero.	

5. Weighing Units

5.1. Units

- All weighing units and weighing modes are as follows:

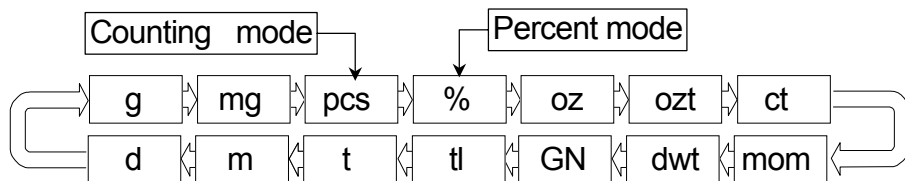

Density mode

- To use this mode, it must be stored in the function table as described on page 14. For details about this mode, refer to "14. Density Measurement".
- To select this mode, press the **MODE** key until the processing indicator ◀ blinks with the unit "g" displayed.

- A unit or mode can be selected and stored in the function table as described in "5.2. Changing the Units".
- If the law in your area permits, you may use all of the units. You can disable the units that you don't regularly use. And you are able to turn them back on.
- If a weighing mode (or unit of mass) has been turned off, that mode or unit will be missing in the sequence. Tael has four varieties, one of which can be selected and installed at the factory.
- To select a unit or mode for weighing, press the **MODE** key.
- For details about the units and modes, see the table below:

Name (unit, mode)	Abbreviation	Display unit	Conversion factor
Gram	g	g	1 g
Milligram	mg	mg	0.001 g
Counting mode	pcs	pcs	-
Percent mode	%	%	-
Ounce (Avoir)	oz	oz	28.349523125 g
Troy Ounce	ozt	ozt	31.1034768 g
Metric Carat	ct	ct	0.2 g
Momme	mom	mom	3.75 g
Pennyweight	dwt	dwt	1.55517384 g
Grain (UK)	GN	GN	0.06479891 g
Tael (HK general, Singapore)	tl	tl	37.7994 g
Tael (HK jewelry)			37.429 g
Tael (Taiwan)			37.5 g
Tael (China)			31.25 g
Tola (India)	t	t	11.6638038 g
Messghal	m	m	4.6875 g
Density mode	d	Refer to "14. Density Measurement"	

- The tables below indicate the weighing capacity and the readability for each unit, depending on the balance model.

Unit	GH-252			
	Standard range		Precision range	
	Capacity	Readability	Capacity	Readability
Gram	250	0.0001	101	0.00001
Milligram	250000	0.1	101000	0.01
Ounce (Avoir)	8.82	0.00001	3.56	0.000001
Troy Ounce	8.04	0.00001	3.25	0.000001
Metric Carat	1250	0.001	505	0.0001
Momme	66.7	0.0001	26.9	0.00001
Pennyweight	160.8	0.0001	64.9	0.00001
Grain (UK)	3858	0.002	1559	0.0002
Tael (HK general, Singapore)	6.61	0.00001	2.67	0.000001
Tael (HK jewelry)	6.68	0.00001	2.70	0.000001
Tael (Taiwan)	6.67	0.00001	2.69	0.000001
Tael (China)	8.00	0.00001	3.23	0.000001
Tola (India)	21.43	0.00001	8.66	0.000001
Messghal	53.3	0.0001	21.5	0.00001

Unit	GH-202			
	Standard range		Precision range	
	Capacity	Readability	Capacity	Readability
Gram	220	0.0001	51	0.00001
Milligram	220000	0.1	51000	0.01
Ounce (Avoir)	7.76	0.00001	1.80	0.000001
Troy Ounce	7.07	0.00001	1.64	0.000001
Metric Carat	1100	0.001	255	0.0001
Momme	58.7	0.0001	13.6	0.00001
Pennyweight	141.5	0.0001	32.8	0.00001
Grain (UK)	3395	0.002	787	0.0002
Tael (HK general, Singapore)	5.82	0.00001	1.35	0.000001
Tael (HK jewelry)	5.88	0.00001	1.36	0.000001
Tael (Taiwan)	5.87	0.00001	1.36	0.000001
Tael (China)	7.04	0.00001	1.63	0.000001
Tola (India)	18.86	0.00001	4.37	0.000001
Messghal	46.9	0.0001	10.9	0.00001

Unit	GH-300	GH-200	GH-120	Readability
	Capacity			
Gram	320	220	120	0.0001
Milligram	320000	220000	120000	0.1
Ounce (Avoir)	11.29	7.76	4.23	0.00001
Troy Ounce	10.29	7.07	3.86	0.00001
Metric Carat	1600	1100	600	0.001
Momme	85.3	58.7	32.0	0.0001
Pennyweight	205.8	141.5	77.2	0.0001
Grain (UK)	4938	3395	1852	0.002
Tael (HK general, Singapore)	8.47	5.82	3.17	0.00001
Tael (HK jewelry)	8.55	5.88	3.21	0.00001
Tael (Taiwan)	8.53	5.87	3.20	0.00001
Tael (China)	10.24	7.04	3.84	0.00001
Tola (India)	27.44	18.86	10.29	0.00001
Messghal	68.3	46.9	25.6	0.0001

5.2. Changing the Units

- The units or modes can be selected and stored in the function table. The sequence of displaying these can be arranged to fit the frequency of use. The units stored are maintained in non-volatile memory, even if the AC adapter is removed.

- Press and hold the **RANGE** key (for approx. 2 seconds) until **bASFnC** of the function table is displayed in the weighing mode, then release the key.
- Press the **RANGE** key several times to display **Unit**.
- Press the **PRINT** key to enter the unit selection mode.
- Specify a unit or mode in the order to be displayed using the following keys.
 - RANGE** key To display the units sequentially.
 - RE-ZERO** key To specify a unit or mode.

The stabilization indicator **o** appears when the displayed unit or mode is specified.

Examples

Unit		Display
Gram	g	o Unit g
Milligram	mg	o Unit mg
Counting mode	pcs	o Unit pcs
Percent mode	%	o Unit %
Density mode	d	o Unit d

- Press the **PRINT** key to store the units or modes. The balance displays **End** and then displays the next menu item of the function table.
- Press the **CAL** key to exit the function table. Then the balance returns to the weighing mode with the selected unit.

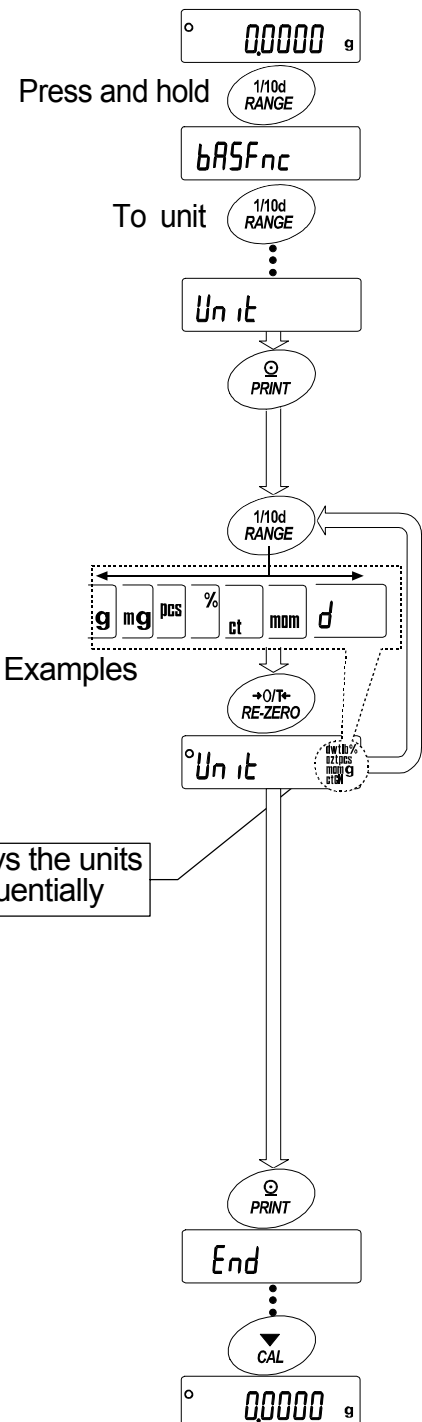

5.2.1. Unit setting example

The example below sets the units in the order with g (gram) as the first unit followed by pcs (counting mode).

- 1 Press and hold the **RANGE** key (for approx. 2 seconds) until **bASFnC** of the function table is displayed in the weighing mode, then release the key.
- 2 Press the **RANGE** key several times to display **Unit**.
- 3 Press the **PRINT** key to enter the unit selection mode.
- 4 Press the **RE-ZERO** key to specify the unit of g. The stabilization indicator **○** appears when the unit is specified.
- 5 Press the **RANGE** key several times to display **Unit pcs**.
- 6 Press the **RE-ZERO** key to specify the unit of pcs. The stabilization indicator **○** appears when the unit is specified.
- 7 Press the **PRINT** key to store the units. The balance displays **End** and then displays the next menu item of the function table.
- 8 Press the **CAL** key to exit the function table. Then the balance returns to the weighing mode with g, the unit selected first.
- 9 Press the **MODE** key to switch between g and pcs (g→pcs).

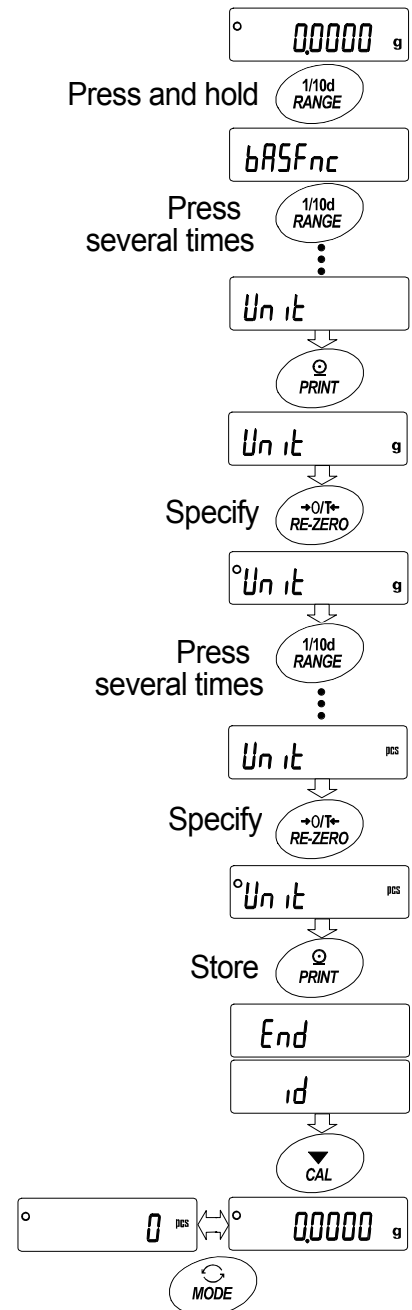

6. Weighing

Precautions for the weighing operation

- Press the **RE-ZERO** key each time, before placing a sample on the weighing pan, to prevent possible errors.
- Place a sample in the center of the weighing pan gently.
- Temperature changes during measurement may cause weighing error.
- Shorten the operation time as much as possible. (Opening and closing door, putting and removing sample)
- Use a pair of tweezers to avoid a temperature change due to having your hand in the weighing chamber.
- Material with an electrostatic charge or that is magnetic may cause a weighing error.
- Do not press keys with a sharp instrument (such as a pencil or ball point pen).
- Do not drop things on the pan, or place a weight on the pan that is beyond the weighing range of the balance.
- Calibrate your balance periodically to maintain weighing accuracy. Refer to section "8. Calibration".
- Keep the area clean and dry.
- Consider section "3. Precautions" for the weighing operation.
- For precision weighing, keep the AC adapter connected to the balance.

6.1. Basic Operation (Gram Mode)

Read section "4. Display symbols and Key operation" before operation.

Note When turning on the balance with a container placed on the pan, the tare function sets the display to zero automatically.

- 1 Turn on the balance using the **ON:OFF** key.
- 2 Select a preset unit (g or mg) using the **MODE** key.
- 3 Place the container on the weighing pan, if necessary.
Press the **RE-ZERO** key to cancel the weight (tare). Then zero is displayed.
Container : A vessel placed on the pan, but not to be included in the weighing data.
- 4 Place a sample on the pan or in the container.
- 5 Wait for the stabilization indicator **○** to be displayed, then read the value.
- 6 Remove the sample and container from the pan.

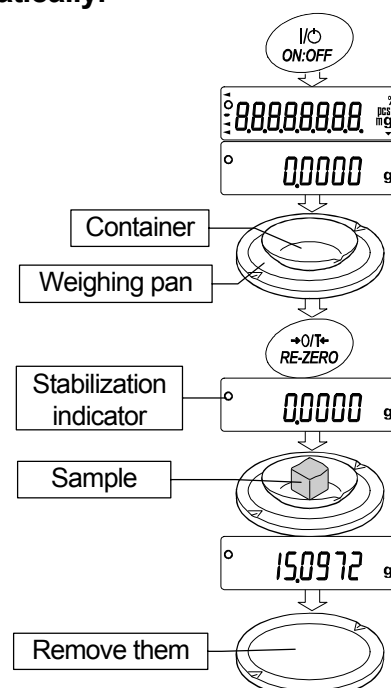

6.2. Dual Range

	Weighing range		Available readability		
	GH-252	GH-202	0.01 mg	0.1 mg	1 mg
Precision range	0 g to 101 g	0 g to 51 g	0.01 mg	0.1 mg	1 mg
Standard range	101 g to 250 g	51 g to 220 g		0.1 mg	1 mg

The GH-252 and GH-202 are equipped with two ranges "precision range" and "standard range".

- When weighing is started by pressing the **ON:OFF** key, the readability will be 0.1 mg.
- Pressing the **RANGE** key will switch these ranges alternately.

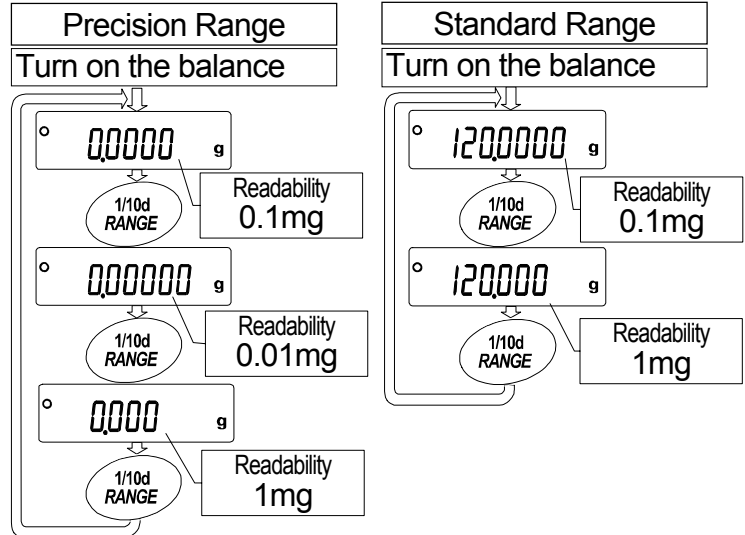

- When a sample is weighed using the precision range with a readability of 0.01 mg and the weight value exceeds the precision range value, the readability changes to 0.1 mg of the standard range. When removing the sample, the readability changes to 0.01 mg of the precision range automatically.
- When a tare weight (container mass value) exceeds the precision range value, even if the sample is within the precision range value, 0.01 mg of the precision range can not be selected for the readability. In order to select 0.01 mg of the precision range, remove the tare weight and press the **RE-ZERO** key to cancel it.
- When a readability of 0.1 mg or 1 mg is selected by the **RANGE** key, the readability is maintained even if the range is changed during weighing.

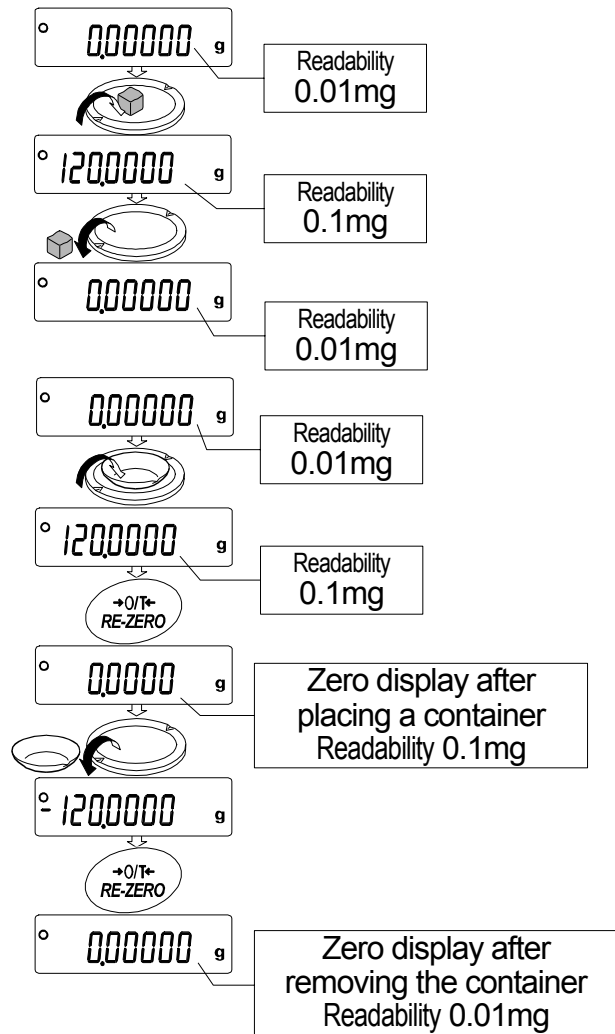

6.3. Counting Mode (PCS)

- This is the mode to determine the number of objects in a sample based on the standard sample unit mass. The unit mass means an average mass of the samples. The smaller the variation in the samples, the more accurate the count will be. The balance is equipped with the Automatic Counting Accuracy Improvement (ACAI) function to improve the counting accuracy.

Notes

- Use samples with a unit mass of 1 mg or more for counting.
- If the sample unit mass variable is too large, it may cause a counting error.
- To improve the counting performance, use the ACAI function frequently or divide the samples into several groups and count each group.

Selecting the counting mode

- 1 Press the **MODE** key to select the unit **pcs** (counting mode).

Storing a sample unit mass (Weighing input mode)

- 2 Press the **RANGE** key to enter the sample unit mass storing mode.

- 3 To select the number of samples using the **RANGE** key. It may be set to 10, 25, 50 or 100.

Advise A greater number of samples will yield more accurate counting result.

- 4 Place a container on the weighing pan, if necessary. Press the **RE-ZERO** key to cancel the weight (tare). The number specified in step 3 appears.

Example: **25 0** pcs is displayed if 25 is selected in step 3.

- 5 Place the number of samples specified on the pan. In this example, 25 pieces.

- 6 Wait for the stabilization indicator to be displayed. Press the **PRINT** key to calculate and store the unit mass. Then the balance displays **25 pcs** and is set to count samples with this unit mass. (The sample unit mass is stored in non-volatile memory, and is maintained even if the AC adapter is removed.) To improve the accuracy of the unit mass, proceed to step 8.

Notes

- If the balance judges that the mass of the samples is too light (under 0.0001g) and can not be stored as the unit mass, it displays **Lo**.
- If the balance judges that the mass of the samples is too light to acquire accurate weighing, it displays an error requiring the addition of more samples to the specified number. Example: **50 - pcs** appears, requiring 25 more samples. Add 25 samples and press the **PRINT** key. When the unit mass is stored correctly, the balance proceeds to the counting mode.

Counting operation

- 7 Place the samples to be counted on the pan.

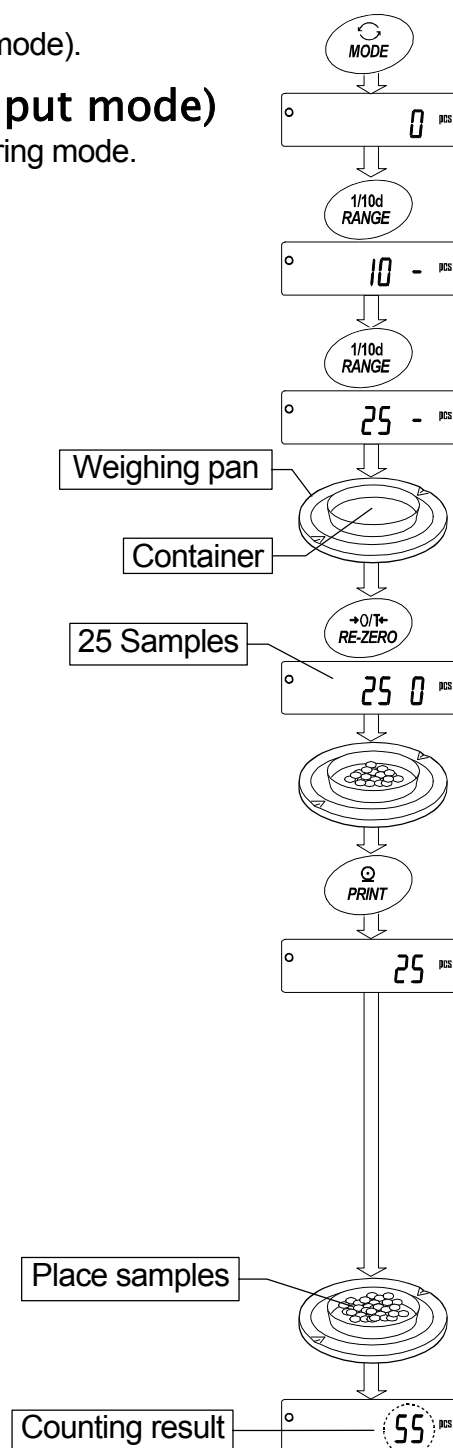

Counting mode using the ACAI function

The ACAI is a function that improves the accuracy of the unit mass automatically by increasing the number of samples as the counting process.

ACAI: Automatic Counting Accuracy Improvement

- 8 If a few more samples are added, the processing indicator turns on. To prevent an error, add three or more. The processing indicator does not turn on if overloaded. Try to add the same number of samples as displayed.
- 9 The balance re-calculates the unit mass while the processing indicator is blinking. Do not touch the balance or samples on the pan until the processing indicator turns off.
- 10 Counting accuracy is improved when the processing indicator turns off. Each time the above operation is performed, a more accurate unit mass will be obtained. There is no definite upper limit to the ACAI range for the number of samples exceeding 100. Try to add the same number of samples as displayed.
- 11 Remove all the samples used in ACAI and proceed with the counting operation using the improved unit mass.

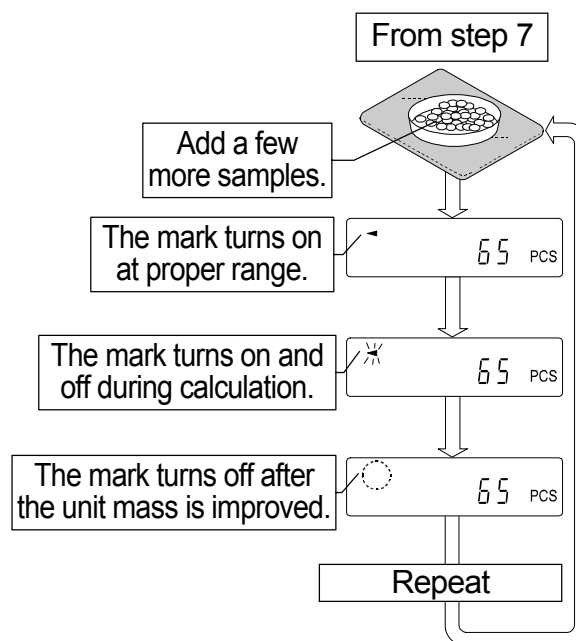

Note ACAI will not function on the unit mass entered using the keys, or digital input mode.

6.4. Percent Mode (%)

The percent mode displays the weight value in percentage compared to a 100% reference mass and is used for target weighing or checking the sample variance.

Selecting the percent mode

- 1 Press the **MODE** key to select the unit **%** (Percent mode).
If the percent mode can not be selected, refer to "5. Weighing Units".

Storing the 100% reference mass

- 2 Press the **RANGE** key to enter the 100% reference mass storing mode.
Even in the storing mode, pressing the **MODE** key will switch to the next mode.
- 3 Place a container on the weighing pan, if necessary. Press the **RE-ZERO** key to cancel the weight (tare). The balance displays **100 0 %**.
- 4 Place the sample to be set as the 100% reference mass on the pan or in the container.
- 5 Press the **PRINT** key to store the reference mass. The balance displays **10000 %**. (The decimal point position depends on the reference value. The reference mass is stored in non-volatile memory, and is maintained even if the AC adapter is removed.)

Note

- Position of decimal point can be changed by 100% mass.

100% mass	Readability
0.0100g to 0.0999g	1%
0.1000g to 0.9999g	0.1%
1.0000g to weighing capacity	0.01%

- If the balance judges that the mass of the sample is too light (under 0.01g) to be used as a reference, it displays **Lo**.
- A 100% reference mass can be stored in the non-volatile memory and is maintained even if the AC adapter is removed.

- 6 Remove the sample.

Reading the percentage

- 7 Place a sample to be compared to the reference mass on the pan. The displayed percentage is based on the 100% reference mass.

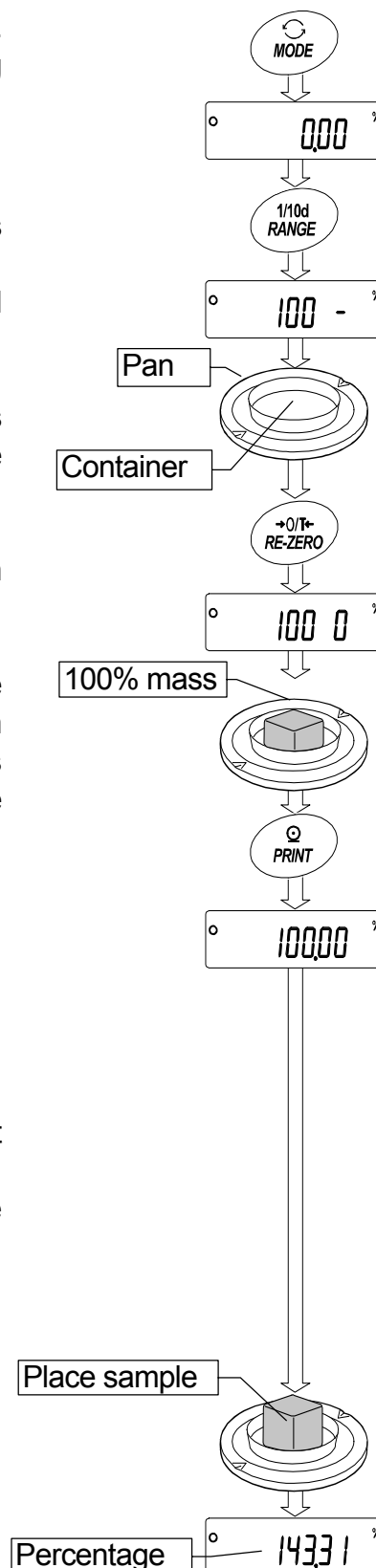

7. Response Adjustment

This function stabilizes the weight value, reducing the influence on weighing that is caused by drafts and/or vibration at the place where the balance is installed. This function adjusts by automatically analyzing the environment or by hand-operation. The function has three stages as follows :

Indicator	Parameter	Response	Stability
FAST	[ond 0]	Fast response, ↑	Sensitive value ↓
MID.	[ond 1]		
SLOW	[ond 2]	Slow response, Stable value	

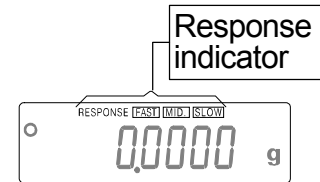

7.1. Automatic Response Adjustment

This function automatically updates the response adjustment by analyzing the influence of the environment using the internal mass.

- 1 Press and hold the [MODE] key (for approx. 2 seconds) until [RESPONSE] is displayed, then release the key.
- 2 The balance automatically sets the response characteristic.
Caution Do not allow vibration or drafts to affect the balance during adjustment.
- 3 After automatic adjustment, the balance displays [End], returns to the weighing mode and displays the updated response indicator for about thirty seconds.

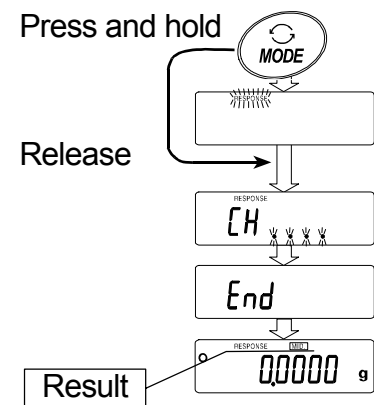

Note

- If the automatic response adjustment fails, the balance displays [CH nG]. Check the ambient conditions such as breeze and vibration, also check the weighing pan. Then, perform the adjustment again. To return to the weighing mode, press the [CAL] key.
- If there is matter on the weighing pan, the balance displays [CH 0]. Remove them from the pan. To return to the weighing mode, press the [CAL] key.

Advise

If the automatic response adjustment is not helpful, try "7.2. Manual Response Adjustment".

7.2. Manual Response Adjustment

- 1 Press and hold the **MODE** key (for approx. 2 seconds) until **RESPONSE** is displayed, then release the key.
Press the **MODE** key again quickly.
- 2 Select a stage of the response adjustment using the **MODE** key. Either **FAST**, **MID.** or **SLOW** can be selected.
- 3 The balance displays **End**, returns to the weighing mode and displays the updated response indicator for about thirty seconds.

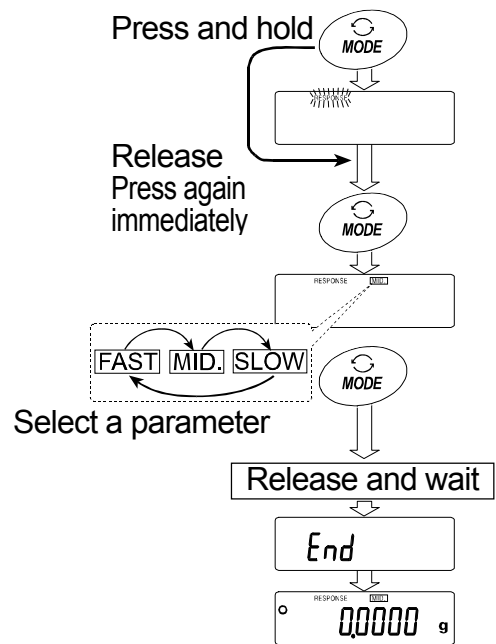

Advise

If the automatic response adjustment is not helpful, specify a parameter for "Condition (*End*)" or "Environment, Display (*bRSFnC*)" with key operation.

8. Calibration

8.1. Calibration Group

Calibration

- Automatic self calibration (Calibration due to changes in temperature)
- Calibration using the internal mass (One-touch calibration)
- Calibration using an external weight that you have

Calibration test

- Calibration test using the internal mass
- Calibration test using target mass that you have

Correction of the internal mass value

- Correction of the internal mass value

Caution

- Do not allow vibration or drafts to affect the balance during calibration.
- Calibration test does not perform calibration.
- To output the data for GLP/GMP using the RS-232C interface, set "GLP output (*inF0*)" of "Data output (*dout*)". Refer to "10. Function Table". Time and date can be added to GLP/GMP report. If the time or date is not correct, adjust them. Refer to "10.7 Clock and Calendar Function".
- Calibration test is available only when "GLP output (*inF0*)" of "Data output (*dout*)" is set.
- The calibration and calibration test data can be stored in memory. To store them, set "Data memory (*dRR*)". Refer to "12. Data Memory" for details.

Caution on using an external weight

- The accuracy of an external weight can influence the accuracy of weighing.
- Select a mass for calibration and calibration test from the following table.

Model	Usable calibration mass	Adjustable range
GH-120	50g, 100g*	-15.0 mg to +15.9 mg
GH-200	100g, 200g*	
GH-300	100g, 200g* , 300g	
GH-202, GH-252	20g, 50g, 100g, 200g*	-15.00 mg to +15.99 mg

The calibration mass in **bold type**: factory setting

The calibration mass value can be adjusted within the range above.

Display

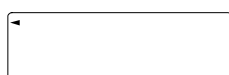

This indicator means "In process of measuring calibration data".

Do not allow vibration or drafts to affect the balance while the indicator is displayed.

About the internal mass

- The internal mass may change due to corrosion or other damage caused by the operating environment, or due to aging. Check the internal mass periodically and correct the internal mass value if necessary.

8.2. Automatic Self Calibration

Automatic self calibration due to changes in temperature

This function automatically calibrates the balance when the balance detects an ambient temperature change. If GLP output is selected in the function table, the balance outputs the calibration report or stores the data in memory. Automatic self calibration functions even if the display is turned off (standby state). Refer to "9-1. Permit Or Inhibit" for the operation.

Caution

- **When using automatic self calibration, do not place something on the weighing pan.**
- **If something is on the weighing pan, the balance decides that it is in use and does not perform automatic self calibration.**
- **When weighing a light sample or installing the balance in a system, turn off automatic self calibration.**

Note When turning on the balance with nothing on the pan, if a sample heavier than 0.5 g is placed on the pan, the balance detects the state that a sample is placed on the pan and does not perform the automatic self calibration.

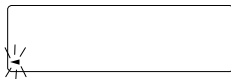

The mark ◀ is "prior notice indicator of automatic self calibration".

When the balance detects a change in ambient temperature, this indicator blinks and automatic self calibration is required. If the balance is not used for several minutes with this indicator blinking, the balance performs automatic self calibration. The environment will affect the time that the indicator blinks.



The balance is measuring calibration data. Do not allow vibration or drafts to affect the balance while this indicator is displayed. After calibration, the balance returns to indicate the previous display.

Advise

The balance can be used while the indicator blinks. But, it is recommended that to maintain the accuracy, stop using the balance and confirm that there is nothing on the pan and allow the balance to perform self calibration.

8.3. One-Touch Calibration

This function calibrates the balance using the internal mass.

The only operation required is to press the **CAL** key.

- 1 Connect the AC adapter and warm up the balance for at least one hour with nothing on the weighing pan.
- 2 Press the **CAL** key to display **CAL in**.
- 3 The balance performs calibration using the internal mass. Do not allow vibration or drafts to affect the balance.
- 4 The balance displays **End** after calibration. If the GLP output is set, the balance displays **GLP** and outputs the calibration report using the RS-232C interface or stores the data in memory. Refer to "GLP output (INF0)" and "Data memory (DATA)" of the function table.
- 5 The balance will automatically return to the weighing mode after calibration.
- 6 Confirm weighing accuracy using calibration test (**EE in**).

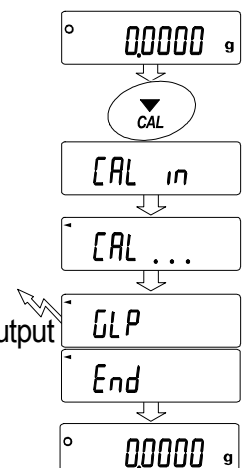

8.4. Calibration Test Using the Internal Mass

This function tests the balance accuracy using the internal mass. (Balance is not calibrated)
When the GLP output is set, the calibration test report is output or stored.

- 1 Connect the AC adapter and warm up the balance at least one hour.
- 2 Press and hold the **CAL** key (for approx. 2 seconds) until is **[[in** displayed, then release the key.
- 3 The balance measures the zero point.
Prevent vibration and drafts to affect the balance.
- 4 The measured zero point data is displayed.
- 5 The balance measures the full scale data.
Prevent vibration and drafts to affect the balance.
- 7 The full scale data is displayed. The tolerance of the full scale data is $\pm 0.2\text{mg}$.

Model	Full scale data
GH-120	100.000 g
GH-200, GH-300, GH-202, GH-252	200.000 g

- 8 When the GLP output is set, the calibration test report is output or stored.
 - Refer to "GLP output (INF0)" and "Data memory (dARA)" of the function table.
 - The zero point data and full scale data is displayed (or output) in unit of 0.0001g.
- 8 The balance automatically returns to the weighing mode.

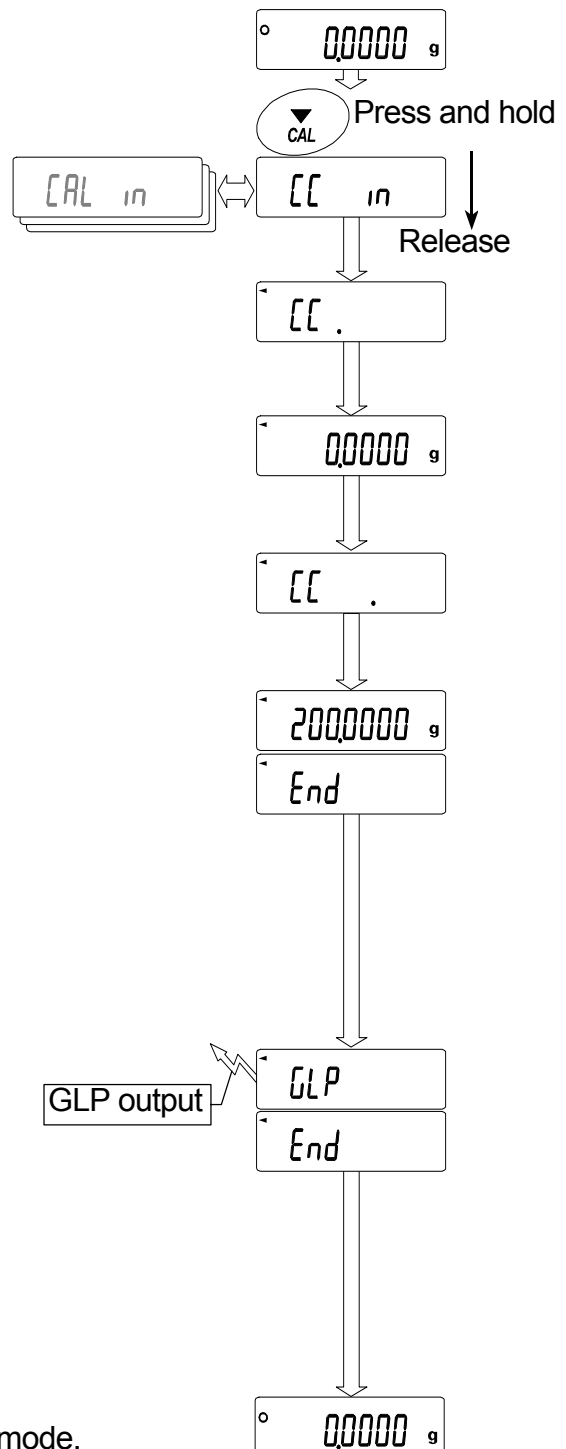

8.5. Calibration Using an External Weight

This function calibrates the balance using an external weight.

- 1 Connect the AC adapter and warm up the balance for at least one hour with nothing on the weighing pan.
- 2 Press and hold the **CAL** key (for approx. 2 seconds) until **CALout** is displayed, then release the key.
- 3 The balance displays **CAL 0**.
 - If you want to change the calibration mass, press the **RANGE** key and proceed to step 4.
 - If you use the calibration mass value stored in the balance, proceed to step 5.
- 4 Specify the calibration mass value as follows:
 - RANGE** key..... The key to switch blinking figures.
 - RE-ZERO**(+)**key** ... The keys to select the calibration mass or adjust the mass value. Refer to page 23.
 - MODE**(-)**key**
 - PRINT** key..... The key to store the new mass value. Even if the AC adapter is removed, the data is maintained in non-volatile memory.
 - CAL** key..... The key to cancel the operation and return to **CAL 0**.
- 5 Confirm that there is nothing on the pan and press the **PRINT** key. The balance measures the zero point. Do not allow vibration or drafts to affect the balance. The balance displays the calibration mass value.
- 6 Place the displayed calibration weight on the pan and press the **PRINT** key. The balance measures the calibration mass. Do not allow vibration or drafts to affect the balance.
- 7 The balance displays **End**. Remove the weight from the pan.
- 8 If the "GLP output (*inFd*)" the function table is set, the balance displays **GLP** and outputs or stores "Calibration Report". Refer to "11.2. GLP Report" for details.
- 9 The balance will automatically return to the weighing mode.
- 10 Place the calibration weight on the pan and confirm that the value displayed is correct. If it is not within the range, check the ambient conditions such as breeze and vibration also check the weighing pan. Then, repeat steps 1 to 10.

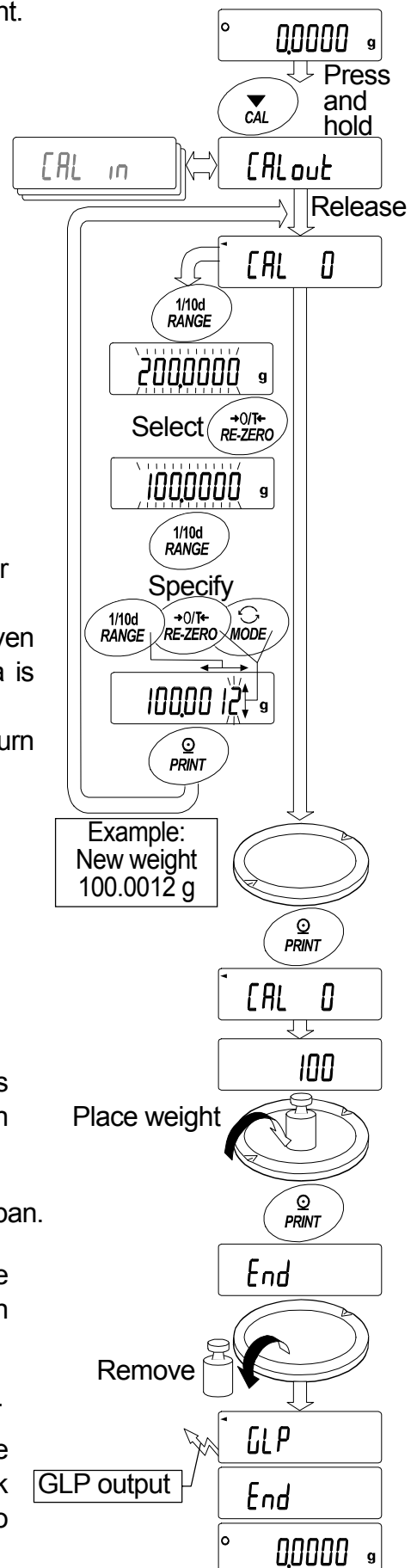

8.6. Calibration Test Using an External Weight

This function tests the weighing accuracy using an external weight. Calibration test report can be output or stored with "GLP output (inF0)" (Calibration test does not perform calibration).

- 1 Connect the AC adapter and warm up the balance for at least one hour with nothing on the weighing pan.
- 2 Press and hold the **CAL** key (for approx. 2 seconds) until **[[out** is displayed, then release the key.
- 3 The balance displays **[[0**.
 - If the target mass is changed, press the **RANGE** key and proceed to step 4. A list of usable weights is on page 23.
 - If current target mass value is used, proceed to step 5.
- 4 Specify the target mass value as follows:
 - RANGE** key..... The key to switch blinking figures.
 - RE-ZERO**(+)key..... The keys to select the target mass or adjust the mass value. Refer to page 23.
 - MODE**(-)key..... adjust the mass value. Refer to page 23.
 - PRINT** key..... The key to store the new mass value. Even if the AC adapter is removed, the data is maintained in non-volatile memory.
 - CAL** key..... The key to cancel the operation and return to **[[0**.
- 5 Confirm that there is nothing on the pan and press the **PRINT** key. The balance measures the zero point and displays the measured value. Do not allow vibration or drafts to affect the balance. The balance displays the target mass value.
- 6 Place the displayed target mass on the pan and press the **PRINT** key. The balance measures the target mass and displays the measured value. Do not allow vibration or drafts to affect the balance.
- 7 The balance displays **End**. Remove the weight from the pan.
- 8 The balance displays **GLP** and outputs or stores "calibration test report. Refer to "11.2. GLP Report" of the function table for details.
- 9 The balance will automatically return to the weighing mode.

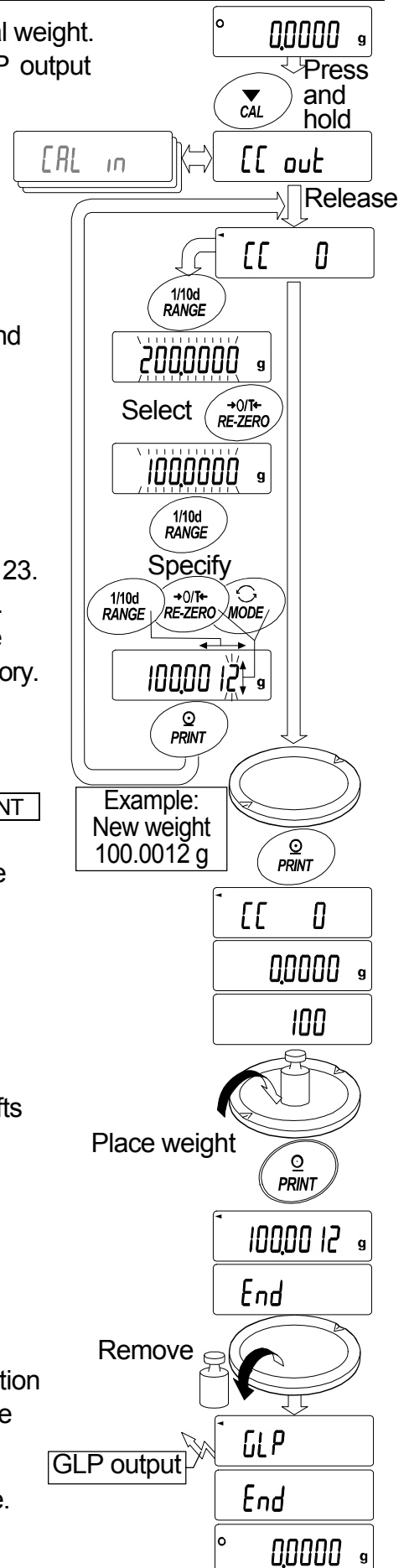

8.7. Correcting the Internal Mass Value

The balance can correct the internal mass value within the range shown below. This function corrects the internal mass value to conform to an external weight. The corrected mass value is maintained in non-volatile memory even if the AC adapter is removed. The internal mass value is corrected as follows:

Model	Target	Range
GH-120	100.000 g	±1.5 mg
GH-200	200.000 g	
GH-300		
GH-202		
GH-252		

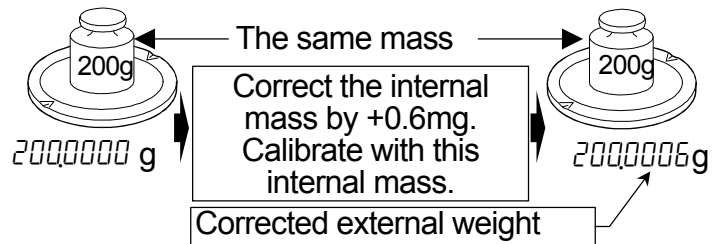

- 1 Calibrate the balance using the internal mass. (one-touch calibration)
Example: 200.0000 g is corrected to +0.6 mg (200.0006 g). When correcting a 100 g external weight by +0.6 mg, the weight changed into 200 g, the correction value is +1.2 mg.

- 2 Press the **ON:OFF** key to turn off the display.
- 3 While pressing and holding the **PRINT** key and the **RANGE** key, press the **ON:OFF** key. The balance displays **P5**.

- 4 Press the **PRINT** key. Then the balance displays the function switches. Set the function table switch and internal mass correction switch to "I" as shown above using the following keys.

- RANGE** key..... The key to select blinking figure.
- RE-ZERO** key..... The key to change the value of the blinking figure..
- PRINT** key The key to store it and return to weighing mode.
- CAL** key..... The key to cancel current operation.

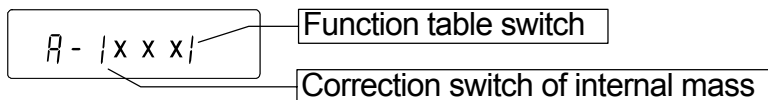

- 5 Press and hold the **RANGE** key (for approx. 2 seconds) to enter the function table and release the key when **bRSFnc** is displayed.
- 6 Press the **RANGE** key several times until **ES in** is displayed, then release the key.
- 7 Press **PRINT** key. Correct the internal mass value using the following keys.
 - RE-ZERO**(+)key .. The key to select the value.
 - MODE**(-)key The key to select the value.
 - PRINT** key The key to store the new value and display the next menu item of the function table.
 - CAL** key..... The key to cancel this correction and display the next menu item of the function table.
- 8 Press the **CAL** key to return the weighing mode.
- 9 Press the **CAL** key to calibrate the balance using the internal mass.
- 10 Check the correction that has been performed properly with the external weight. If the value is incorrect, repeat the correction.

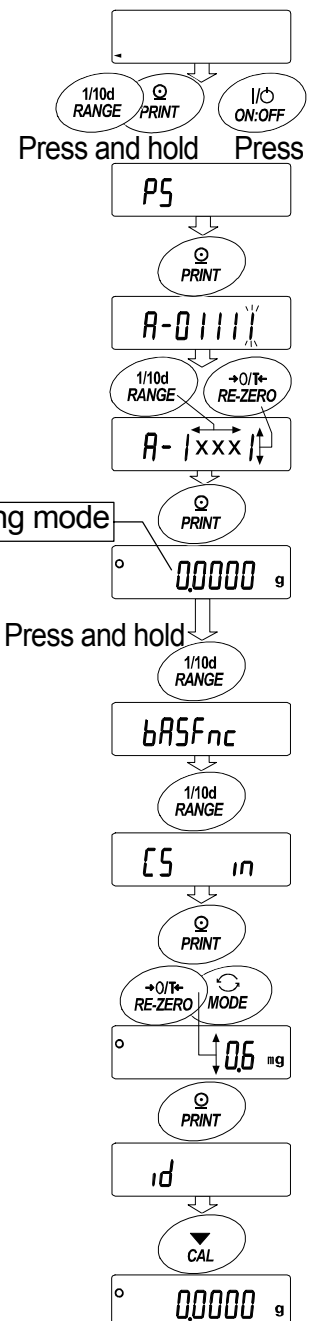

9. Function Switch and Initialization

9.1. Permit or Inhibit

The balance stores parameters that must not be changed unintentionally (Example: Calibration data for accurate weighing, Data for adapting to the operating environment, Control data for the RS-232C interface). There are five switches for the purpose of protecting parameters. Each switch can select either "permit" or "inhibit". "Inhibit" protects parameters against unintentional operations.

- 1 Press the **ON:OFF** key to turn off the display.
- 2 While pressing and holding the **PRINT** key and the **RANGE** key, press the **ON:OFF** key to display **P5**.
- 3 Press the **PRINT** key. Then the balance displays the function switches.
- 4 Specify the switches using the following keys.

RANGE key The key to select blinking digit.

RE-ZERO key The key to change the parameter for the selected switch.

□ To inhibit changes. (Can not be used.)

! To permit changes. (Can be used.)

PRINT key The key to store the new parameter and return to the weighing mode.

CAL key The key to cancel current operation and return to the weighing mode.

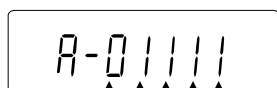

Function table

□ To inhibit changes to the function table.

! To permit changes to the function table.

Calibration using the internal mass (One-touch calibration)

□ To inhibit calibration using the internal mass.

! To permit calibration using the internal mass.

Calibration using the external weight

□ To inhibit calibration using the external weight.

! To permit calibration using the external weight.

Automatic self calibration (due to changes of ambient temperature)

□ To inhibit automatic self calibration.

! To permit automatic self calibration.

Internal mass correction

□ To inhibit correction.

! To permit correction.

9.2. Initializing the Balance

This function returns the following parameters to factory settings.

- Calibration data
- Function table
- The sample unit mass value (counting mode),
100% reference mass value (percent mode)
- The data that is stored in the balance using the data memory function
- External calibration weight and target mass value
- Function switch settings ("9.1. Permit Or Inhibit")
- Liquid density and temperature in the density mode

Note Be sure to calibrate the balance after initialization.

- 1 Press the **ON:OFF** key to turn off the display.
- 2 While pressing and holding the **PRINT** key and the **RANGE** key, press the **ON:OFF** key to display **P5**.
- 3 Press the **RANGE** key to display **ELr**.
- 4 Press the **PRINT** key.
To cancel this operation, press the **CAL** key.
- 5 Press the **RE-ZERO** key to display **ELr 00**.
- 6 Press the **PRINT** key to initialize the balance.
The balance will automatically return to the weighing mode.

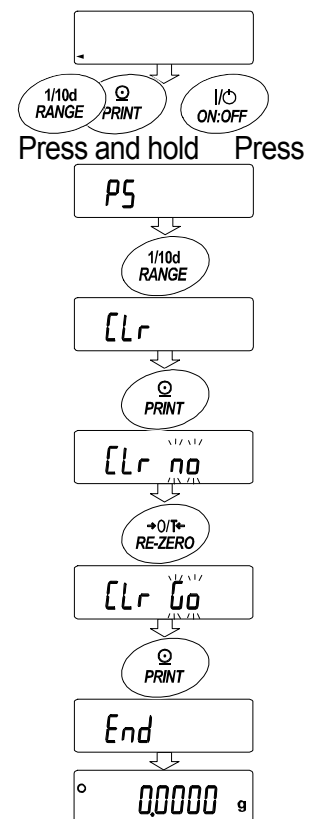





10. Function Table

The function table reads or rewrites the parameters that are stored in the balance. These parameters are maintained in non-volatile memory, even if the AC adapter is removed.

The function table menu consists of two layers. The first layer is the "Class" and the second layer is the "Item".

10.1. Setting the Function Table

Display symbol and keys

	The symbol "O" shows effective parameter.
	When pressing and holding the key in the weighing mode, the mode enters the function table mode. The key to select the class or item in the function table mode.
	The key to change the parameter.
	When displaying a class, the key enters an item in the class. When displaying an item, the key stores the new parameter and displays the next class.
	When displaying an item, the key cancels the new parameter and displays the next class. When displaying a class, the key exits the function table mode and returns to the weighing mode.

Setting procedure

- 1 Press and hold the **RANGE** key (for approx. 2 seconds) until **bASFC** of the function table is displayed in the weighing mode, then release the key
- 2 Press the **RANGE** key to select a class.
- 3 Press the **PRINT** key to enter the class
- 4 Press the **RANGE** key to select a item.
- 5 Press the **RE-ZERO** key to select a parameter for the selected item.
- 6 If storing parameters of the selected class, press the **PRINT** key.
Then the next class is displayed.
If canceling the current operation, press the **CAL** key. Then the next class is displayed.
- 7 When specifying parameters for another class, proceed to step 2.
When finishing the setting, press the **CAL** key to return to weighing mode.

Setting example

This example sets "Stores weighing data" for "Data memory" and "1 minute" for "Interval time".

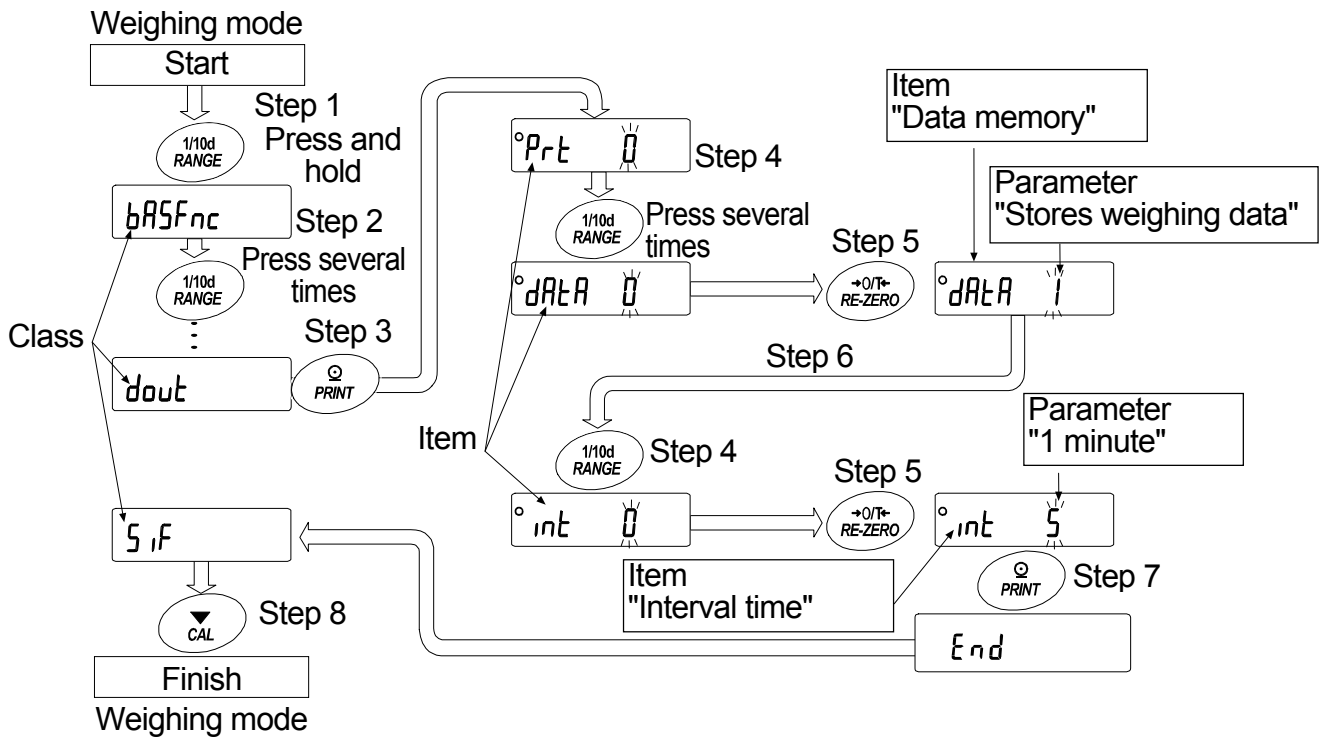

10.2. Details of the Function Table

Class	Item and Parameter		Description	
<i>bR5Fnc</i> Environment Display	<i>Cond</i> Condition	0	Fast response, sensitive value FAST	
		1	↕	
		2	Slow response, stable value SLOW	
				↕
	<i>St-b</i> Stability band width	0	Stable range is ±1 digit	#1
		1	↕	
		2	Stable range is ±3 digits	
<i>trc</i> Zero tracking	0	OFF	Keeps zero display by tracking zero drift.	
	1	Normal		
	2	Strong		
	3	Very strong		
<i>SPd</i> Display refresh rate	0	5 times/second	Period to refresh the display	
	1	10 times/second		
<i>Pnt</i> Decimal point	0	Point (.)	Decimal point format	
	1	Comma (,)		
<i>P-on</i> Auto display-ON	0	OFF	Turns on the weighing mode display when the AC adapter is connected.	
	1	ON		
<i>CL Add</i> Clock	Refer to "10.7. Clock and Calendar Function"		The time and date are added to the output data.	
<i>dout</i> Data output	<i>Prt</i> Data output mode	0	Key mode	Accepts the PRINT key only when the display is stable.
		1	Auto print mode A (Reference = zero)	Outputs data when the display is stable and conditions of <i>RP-P</i> , <i>RP-b</i> and the reference value are met.
		2	Auto print mode B (Reference = last stable value)	
		3	Stream mode / Interval memory mode	With <i>dARA</i> 0, outputs data continuously; with <i>dARA</i> 2, uses interval memory.
	<i>RP-P</i> Auto print polarity	0	Plus only	Displayed value > Reference
		1	Minus only	Displayed value < Reference
		2	Both	Regardless of displayed value
<i>RP-b</i> Auto print difference	0	10 digits	Difference between reference value and displayed value #2	
	1	100 digits		
	2	1000 digits		
<i>dARA</i> Data memory	0	Not used	Related items: <i>Prt</i> , <i>int</i> , <i>d-no</i> , <i>S-td</i> , <i>info</i>	
	1	Stores weighing data		
	2	Stores calibration data		

▪ : Factory settings.

#1 The unit of readability is digit.

Example: If 1 mg display is selected using the RANGE key for the GH-300, 1 mg is one digit.

#2 Usable readability of the balance is one digit.

Example: In gram display, one digit is 0.01 mg for the GH-252 and 0.1 mg for the GH-300.

Class	Item and Parameter	Description		
<i>dout</i> Data output	<i>int</i> Interval time	0	Every measurement	Interval time in the interval memory mode when using <i>Prt 3, dRtA 1</i>
		1	2 seconds	
		2	5 seconds	
		3	10 seconds	
		4	30 seconds	
		5	1 minute	
		6	2 minute	
		7	5 minute	
	8	10 minute		
	<i>d-no</i> Data number output	0	No output	Refer to "12. Data Memory"
1		Output		
<i>S-t d</i> Time/Date output	0	No output	Selects whether or not the time or date is added to the weighting data. Refer to "10.7. Clock and Calendar Function" for details.	
	1	Time only		
	2	Date only		
<i>S-id</i> ID number output	0	No output	Selects whether or not the ID number is output.	
	1	Output		
<i>PUSE</i> Data output pause	0	No pause	Selects the data output interval.	
	1	Pause (1.6 seconds)		
<i>At-F</i> Auto feed	0	Not used	Selects whether or not automatic feed is performed.	
	1	Used		
<i>inf0</i> GLP output	0	No output	Selects GLP output method. Refer to "11. ID Number And GLP Report " for details.	
	1	AD-8121 format		
	2	General data format		
<i>Ar-d</i> Zero after output	0	Not used	Adjusts zero automatically after data is output	
	1	Used		
<i>S,IF</i> Serial interface	<i>bPS</i> Baud rate	0	600 bps	
		1	1200 bps	
		2	2400 bps	
		3	4800 bps	
		4	9600 bps	
	<i>btPr</i> Data bit, parity bit	0	7 bits, even	
		1	7 bits, odd	
		2	8 bits, none	
	<i>CrLF</i> Terminator	0	CR LF	CR: ASCII code 0Dh LF: ASCII code 0Ah
		1	CR	
<i>TYPE</i> Data format	0	A&D standard format	Refer to "10.5. Description of Item "Data Format".	
	1	DP format		
	2	KF format		
	3	MT format		
	4	NU format		
	5	CSV format		

▪ : Factory settings.

Caution The balance may not transmit the data completely at the specified refresh rate, depending on the baud rate or data added to the weighing data such as time, date and ID number.

Class	Item and Parameter		Description	
Serial interface	Timeout	0	No limit	Selects the wait time to receive a command.
		1	1 second	
	AK, Error code	0	No output	AK: ASCII code 06h
1		Output		
CTS, RTS control	0	Not used	Controls CTS and RTS.	
	1	Used		
Density function	Liquid density input	0	Water temperature	Available only when density mode is selected
		1	Liquid density	
Unit			Refer to "5. Weighing Units".	
Internal mass correction			Displayed only when the internal mass value correction switch is set to 1. Refer to "8. Calibration".	
ID number setting			Refer to "11. ID Number And GLP Report".	

▪ : Factory settings. Digit is a unit of readability.

Caution

The balance may not transmit the data completely at the specified refresh rate, depending on the baud rate or data added to the weighing data such as time, date and ID number.

10.3. Description of the Class "Environment, Display"

Condition ($Cond$)

$Cond$ 0



$Cond$ 2

This parameter is for sensitive response to the fluctuation of a mass value. Used for powder target mass, weighing a very light sample or when quick response weighing is required. After setting, the balance displays **FAST**.

This parameter is for stable weighing with slow response. Used to prevent a mass value from drifting due to vibration or drafts. After setting, the balance displays **SLOW**.

Notes In automatic response adjustment, this parameter is selected automatically.

Stability band width ($St-b$)

This item controls the width to regard a mass value as a stable value. When the fluctuation per second is less than the parameter, the balance displays the stabilization indicator and outputs or stores the data. The parameter influences the "Auto print mode"

$St-b$ 0



This parameter is used for sensitive response of the stabilization indicator. Used for exact weighing.

$St-b$ 2

This parameter ignores slight fluctuations of a mass value. Used to prevent a mass value from drifting due to vibration or drafts.

Zero tracking (Trc)

This function tracks zero point drift caused by changes in the environment and stabilizes the zero point. When the weighing data is only a few digits, turn the function off for accurate weighing.

Trc 0

The tracking function is not used. Used for weighing a very light sample.

Trc 1

The normal tracking function is used.

Trc 2

The strong tracking function is used.

Trc 3

The very strong tracking function is used. Used for stable zero display.

Display refresh rate (SPd)

The period to refresh the display. This parameter influences "Baud rate", "Data output pause" and the data output rate of "Stream mode".

Decimal point (Pnt)

The decimal point format can be selected.

Auto display-ON ($P-on$)

When the AC adapter is plugged in, the display is automatically turned on without the **ON:OFF** key operation, to display the weighing mode. Used when the balance is built into an automated system. one hour warm up is necessary for accurate weighing.

10.4. Description of the Item "Data Output Mode"

The parameter setting of "Data output mode (*Prt*)" applies to the performance when the "Data memory (*dAtA*)" parameter is set to "2" (to store the weighing data) and when the data is transmitted using the RS-232C interface.

Key mode

When the PRINT key is pressed with the stabilization indicator turned on, the balance outputs or stores the weighing data and the display blinks one time.

Required setting *dout Prt 0* Key mode

Auto print modes A and B

When the displayed value is stable and the conditions of "Auto print polarity", "Auto print difference" and reference value are met, the balance outputs or stores the weighing data.

When the PRINT key is pressed with the stabilization indicator turned on, the balance outputs or stores the data and the display blinks one time.

Auto print modes A

Example For weighing each time a sample is placed and removed, with "*Ar-d*" set to "1" (to adjust zero after the data is output).

Required setting *dout Prt 1* Auto print mode A (reference = zero)
dout AP-P Auto print polarity
dout AP-b Auto print difference
dout Ar-d 1 Zero after output

Auto print modes B

Example For weighing while a sample is added.

Required setting *dout Prt 2* Auto print mode B (reference = last stable value)
dout AP-P Auto print polarity
dout AP-b Auto print difference

Stream mode

The balance outputs the weighing data continuously regardless of the display condition. When the display refresh rate is set to 5 times / second (*SPd 0*), the data output rate is also set to the same 5 times / second. The display does not blink in this mode. The interval memory mode is used when the "Data memory (*dAtA*)" parameter is set to "1" (to store the weighing data).

Example For monitoring data on a computer.

Required setting *dout Prt 3* Stream mode
dout dAtA 0 Data memory function is not used
bASFnC SPd Display refresh rate
5 iF bPS Baud rate

Caution The balance may not transmit the data completely at the specified refresh rate, depending on the baud rate or data added to the weighing data such as time, date and ID number.

Interval memory mode

The weighing data is periodically stored in memory.

Example	For periodical weighing without a personal computer command and to output all of the data, to a computer, at one time.		
	The GH series can use time and date with "Time/Date output (S-t d)".		
Required setting	<i>dout</i> Prt 3	Interval memory mode	
	<i>dout</i> dRA 2	Data memory function is used	
	<i>dout</i> int	Interval time	
Optional setting	<i>dout</i> S-t d 1, 2, or 3	Adds the time and date.	

10.5. Description of the Item "Data Format"

A&D standard format

S I F T Y P E 0

This format is used when the peripheral equipment can receive the A&D format.

If an AD-8121B is used, set the printer to MODE 1 or 2. With an AD-8127 printer, use the external key printing mode, manual printing mode, auto printing mode or interval printing mode.

- This format consists of fifteen or sixteen characters excluding the terminator.
When numerical characters without decimal point are exceeded eight characters for the GH-252, the format becomes sixteen characters.
- A header of two characters indicates the balance condition.
- The polarity sign is placed before the data with the leading zeros. If the data is zero, the plus sign is applied.
- The unit, consisting of three characters, follows the data.

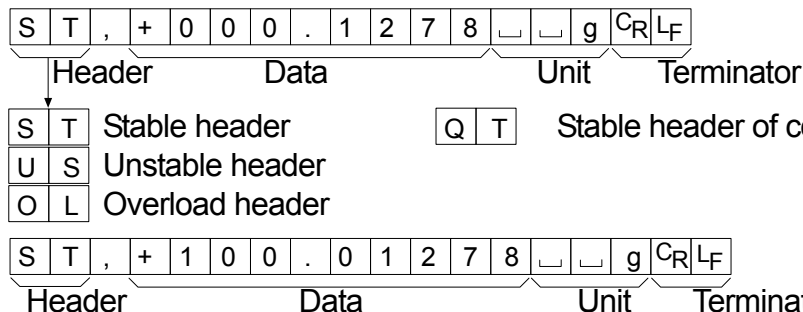

DP (Dump print) format

S I F T Y P E 1

This format is used when the peripheral equipment can not receive the A&D format.

If an AD-8121B is used, set the printer to MODE 3. With an AD-8126 printer, use this format. With an AD-8127 printer, use the dump printing mode.

- This format consists of sixteen characters excluding the terminator.
- A header of two characters indicates the balance condition. No overload header is used.
- The polarity sign is placed before the data, with spaces in place of leading zeros, if the data is not zero or overloaded.
- The unit, consisting of three characters, follows the data.

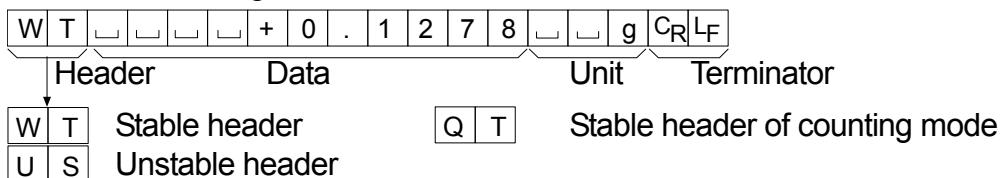

KF format

S IF TYPE 2

This is the Karl-Fischer moisture meter format and is used when the peripheral equipment can only communicate using this format.

- This format consists of fourteen characters excluding the terminator.
- This format has no header characters.
- The polarity sign is placed before the data, with spaces in place of leading zeros, if the data is not zero or overloaded.
- This format outputs the unit only for a stable value.

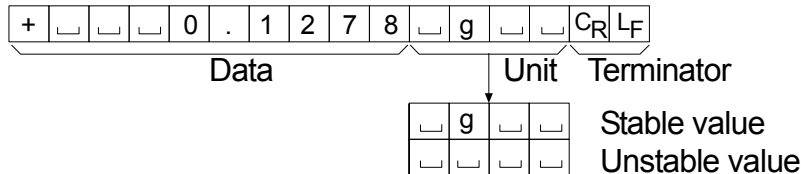

MT format

S IF TYPE 3

- A header of two characters indicates the balance condition.
- The polarity sign is used only for negative data.
- The weighing data uses spaces in place of the leading zeros.
- The character length of this format changes dependent upon the unit

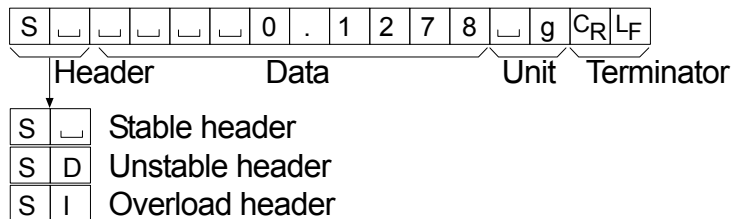

NU (numerical) format

S IF TYPE 4

This format outputs only numerical data.

- This format consists of ten characters excluding the terminator.
- The polarity sign is placed before the data with the leading zeros. If the data is zero, the plus sign is used.

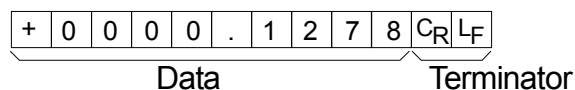

CSV format

5 IF TYPE 5

- This format separates the data of A&D standard format and the unit by a comma (,).
- This format outputs the unit even when the data is overloaded.
- When a comma (,) is selected for the decimal point, the separators are set to semicolon (;).
- When the ID number, data number, time and date are added at "Data output (*dout*)" of the function table, outputs ID number, data number, date, time and weighing data in this order and separates each item by a comma and treats all the items as one group of data.

LAB-0123, No,012, 2004/07/01, 12:34:56, ST,+0000.1278, _ _ g <CR><LF>
 ID number Data number Date Time Weighing data

S	T	,	+	0	0	0	.	1	2	7	8	,	_	_	g	CR	LF			
O	L	,	+	9	9	9	9	9	9	9	E	+	1	9	,	_	_	g	CR	LF

ID number

dout 5-id 1

The number to identify a specific balance.

- This format consists of eight characters excluding the terminator.

L	A	B	-	0	1	2	3	CR	LF
---	---	---	---	---	---	---	---	----	----

Data number

dout d-no 1

This format outputs the data number just before the data is transmitted using the RS-232C interface.

- This format consists of six characters excluding the terminator.
- When CSV format (*5 IF TYPE 5*) is selected, the period (.) is replaced with a comma (,).

N	o	.	0	0	1	CR	LF
---	---	---	---	---	---	----	----

Data number Terminator

Date

dout 5-td 2 or 3

- The date output order can be changed in " Time/Date output (*5-td*)" and "Clock (*CL Add*)". The year is output in a four-digit format.

2	0	0	4	/	0	7	/	0	1	CR	LF
---	---	---	---	---	---	---	---	---	---	----	----

Time

dout 5-td 1 or 3

- This format outputs time in 24-hour format.

1	2	:	3	4	:	5	6	CR	LF
---	---	---	---	---	---	---	---	----	----

10.6. Data Format Examples

Stable

° 0.1278 g

A&D	S	T	,	+	0	0	0	.	1	2	7	8	␣	␣	g	CR	LF		
DP	W	T	␣	␣	␣	␣	␣	+	0	.	1	2	7	8	␣	␣	g	CR	LF
KF	+	␣	␣	␣	0	.	1	2	7	8	␣	g	␣	␣	CR	LF			
MT	S	␣	␣	␣	␣	␣	0	.	1	2	7	8	␣	g	CR	LF			
NU	+	0	0	0	0	.	1	2	7	8	CR	LF							

Unstable

° -18.3690 g

A&D	U	S	,	-	0	1	8	.	3	6	9	0	␣	␣	g	CR	LF		
DP	U	S	␣	␣	␣	␣	-	1	8	.	3	6	9	0	␣	␣	g	CR	LF
KF	-	␣	␣	1	8	.	3	6	9	0	␣	␣	␣	␣	CR	LF			
MT	S	D	␣	␣	-	1	8	.	3	6	9	0	␣	g	CR	LF			
NU	-	0	0	1	8	.	3	6	9	0	CR	LF							

Overload

Positive error

E g

A&D	O	L	,	+	9	9	9	9	9	9	9	E	+	1	9	CR	LF	
DP	␣	␣	␣	␣	␣	␣	␣	␣	␣	E	␣	␣	␣	␣	␣	␣	CR	LF
KF	␣	␣	␣	␣	␣	␣	H	␣	␣	␣	␣	␣	␣	␣	␣	CR	LF	
MT	S	I	+	CR	LF													
NU	+	9	9	9	9	9	9	9	9	9	9	CR	LF					

Overload

Negative error

-E g

A&D	O	L	,	-	9	9	9	9	9	9	9	E	+	1	9	CR	LF	
DP	␣	␣	␣	␣	␣	␣	␣	␣	-	E	␣	␣	␣	␣	␣	␣	CR	LF
KF	␣	␣	␣	␣	␣	␣	L	␣	␣	␣	␣	␣	␣	␣	␣	CR	LF	
MT	S	I	-	CR	LF													
NU	-	9	9	9	9	9	9	9	9	9	9	CR	LF					

␣ Space, ASCII 20h
 CR Carriage Return, ASCII 0Dh
 LF Line Feed, ASCII 0Ah

Units

		A&D	D.P.	KF	MT
g	g	┌┌g┐	┌┌g┐	┌g┌┌┐	┌g┐
mg	mg	┌m┌g┐	┌m┌g┐	┌m┌g┌┐	┌m┌g┐
Counting mode	pcs	┌P┌C┐	┌P┌C┐	┌p┌c┌s┐	┌P┌C┌S┐
Precent mode	%	┌┌%┐	┌┌%┐	┌%┌┌┐	┌%┐
Ounce (Avoir)	oz	┌o┌z┐	┌o┌z┐	┌o┌z┌┐	┌o┌z┐
Troy Ounce	ozt	┌o┌z┌t┐	┌o┌z┌t┐	┌o┌z┌t┐	┌o┌z┌t┐
Metric Carat	ct	┌c┌t┐	┌c┌t┐	┌c┌t┌┐	┌c┌t┐
Momme	mom	┌m┌o┌m┐	┌m┌o┌m┐	┌m┌o┌m┐	┌m┌o┐
Pennyweight	dwt	┌d┌w┌t┐	┌d┌w┌t┐	┌d┌w┌t┐	┌d┌w┌t┐
Grain	GN	┌G┌N┐	┌G┌N┐	┌g┌r┌┐	┌G┌N┐
Tael (HK general, Singapore)	tl	┌t┌l┐	┌t┌l┐	┌t┌l┌s┐	┌t┌l┐
Tael (HK, jewelry)	tl	┌t┌l┐	┌t┌l┐	┌t┌l┌h┐	┌t┌l┐
Tael (Taiwan)	tl	┌t┌l┐	┌t┌l┐	┌t┌l┌t┐	┌t┌l┐
Tael (China)	tl	┌t┌l┐	┌t┌l┐	┌t┌l┌c┐	┌t┌l┐
Tola (India)	t	┌┌t┐	┌┌t┐	┌t┌o┌l┐	┌t┐
Messghal	m	┌m┌e┌s┐	┌m┌e┌s┐	┌M┌S┌┐	┌m┐
Density		┌D┌S┐	┌D┌S┐	┌D┌S┌┐	┌D┌S┐

┌ Space, ASCII 20h

10.7. Clock and Calendar Function

The balance is equipped with a clock and calendar function. When the "GLP output (INF_o)" parameter is set to "1" or "2" and the "Time/Date output (S₋td)" parameter is set to "1", "2" or "3", the time and date are added to the output data. Set or confirm the time and date as follows:

Operation

- 1 Press and hold the **RANGE** key (for approx. 2 seconds) until **bRSFnC** of the function table is displayed in the weighing mode, then release the key.
- 2 Press the **RANGE** key several times to display **CL Add**.
- 3 Press the **PRINT** key.
The balance enters the mode to confirm or set the time and date.

Confirming the time

- 4 The current time is displayed with all the digits blinking.
 - When the time is correct and the date does not need to be confirmed, press the **CAL** key and proceed to step 8.
 - When the time is correct and the date is to be confirmed, press the **RANGE** key and proceed to step 6.
 - When the time is not correct and is to be changed, press the **RE-ZERO** key and proceed to step 5.

Setting the time

- 5 Set the time in 24-hour format using the following keys.
 - RANGE** key..... The key to select the digits to change the value.
The selected digits blink.
 - RE-ZERO**(-)key.... The key to increase the value by one.
 - MODE**(+)key The key to decrease the value by one.
 - PRINT** key The key to store the new setting, display **End** and proceed to step 6.
 - CAL** key..... The key to cancel the new setting and proceed to step 6.

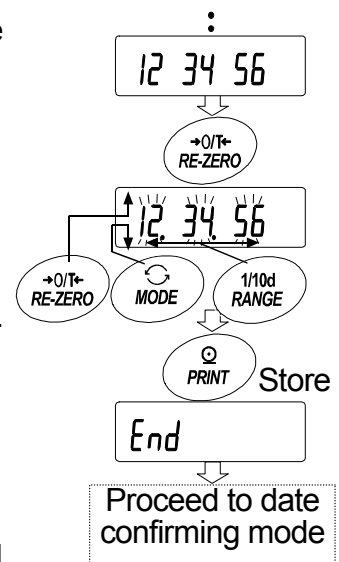

Confirming the date

- 6 The current date is displayed with all the digits blinking.
 - To change the display order of year (y), month (m) and day (d), press the **MODE** key. The date is output in the order as specified.
 - When the date is correct and the operation is to be finished, press the **CAL** key and proceed to step 8.
 - When the time is to be confirmed again, press the **RANGE** key and proceed back to step 4.
 - When the date is not correct and is to be changed, press the **RE-ZERO** key and proceed to step 7.

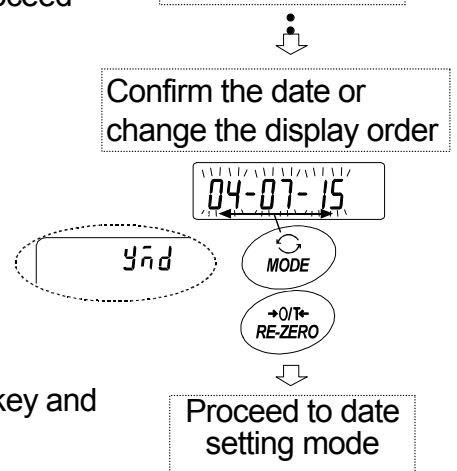

Note The year is expressed using a two-digit format.
For example: The year 2004 is expressed as "04".

Setting the date

7 Set the date using the following keys.

RANGE key The key to select the digits to change the value.
The selected digits blink.

RE-ZERO key The key to increase the value by one.

MODE key The key to decrease the value by one.

PRINT key The key to store the new setting, display
End and proceed to step 8.

CAL key The key to cancel the new setting and
proceed to step 8.

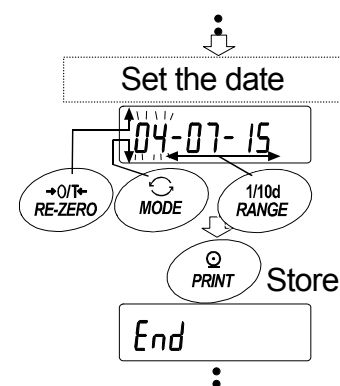

Quitting the operation

8 The balance displays the next menu item of the function table.

Press the **CAL** key to exit the clock and calendar function and
return to the weighing mode.

Note Do not enter invalid values such as a non-existing date
when setting the time and date.

When the clock backup battery has been depleted, the
balance displays **rtc PF**. Under this condition, press
any key and set the time and date. The dead battery only
affects the clock and calendar function. Even so, the
function works normally as long as the AC adapter is
connected to the balance.

11. ID Number and GLP Report

- The ID number is used to identify the balance when Good Laboratory Practice (GLP) or Good Manufacturing Practice (GMP) is used.
 - The output format for GLP/GMP compliant report is selected in "GLP output (*inF0*)" of the function table and can be output to a personal computer or printer using the RS-232C serial interface.
 - The GLP/GMP compliant report includes the balance manufacturer, model, serial number, ID number, date, time and space for signature. The calibration report and the calibration test report include the weight used and the result.
 - The balance can output the following reports for GLP / GMP using the RS-232C serial interface.
 - "Calibration report" of the calibration, using the internal mass (Calibration due to changes in temperature and one-touch calibration.)
 - "Calibration report" of the calibration, using an external weight.
 - "Calibration test report" of the calibration test, using an external weight.
 - "Title block" and "End block" for the weighing data.
 - Calibration and calibration test data can be stored in memory to output several reports at the same time. Refer to "12. Data Memory" for details.
 - For details on confirming and setting the time and date for the GH series. Refer to "10.7. Clock and Calendar Function".
- To output the GLP/GMP compliant report, set the AD-8127 printer to the dump printing mode.

11.1. Setting the ID Number

- 1 Press and hold the **RANGE** key (for approx. 2 seconds) until **bRSFnC** of the function table is displayed, then release the key.
- 2 Press the **RANGE** key several times to display **id**.
- 3 Press the **PRINT** key. Set the ID number using the following keys.
 - RE-ZERO** key..... The key to set the character of the digit selected.
Refer to the display character set shown below.
 - RANGE** key..... The key to select the digit to change the value.
 - PRINT** key The key to store the new ID number and display **bRSFnC**.
 - CAL** key..... The key to cancel the new ID number and display **bRSFnC**.
- 4 With **bRSFnC** displayed, press the **CAL** key to return to the weighing mode.

0	1	2	3	4	5	6	7	8	9	-	␣	A	B	C	D	E	F	G	H	I	J	K	L	M	N	O	P	Q	R	S	T	U	V	W	X	Y	Z
0	1	2	3	4	5	6	7	8	9	-	␣	A	B	C	D	E	F	G	H	I	J	K	L	M	N	O	P	Q	R	S	T	U	V	W	X	Y	Z

␣ Space

11.2. GLP Report

To output the GLP/GMP compliant report to an AD-8121B printer, AD-8127 printer or to a personal computer, set the "GLP output (*inF_o*)" parameter of the function table to "1" (AD-8121 format) or "2" (General format using the balance built-in clock data).

Notes on outputting the GLP/GMP compliant report to a printer

- Refer to "15.2. Connection to Peripheral Equipment" for connection to a printer.
- With an AD-8121B printer, use MODE 3. If MODE1 is used, select temporarily the dump print mode by pressing the **[STAT.]** key of the AD-8121B printer.
With an AD-8127 printer, use the dump printing mode.
If the external key printing mode is used, press and hold the **[ENT]** key of the AD-8127 printer (for approx. 2 seconds) to switch between the external key printing mode and the dump printing mode.
- If the time and date are not correct when the balance built-in clock data is output (*inF_o* 1, 2), set the correct time and date in "Clock (*CL Add*)" of the function table.

Calibration report using the internal mass

Key operation

- 1 Press the **[CAL]** key to display **[CAL in]** and calibrate the balance automatically.
- 2 If GLP output is used, **[GLP]** is displayed and the calibration report is output.
- 3 The balance returns to weighing mode after this calibration.

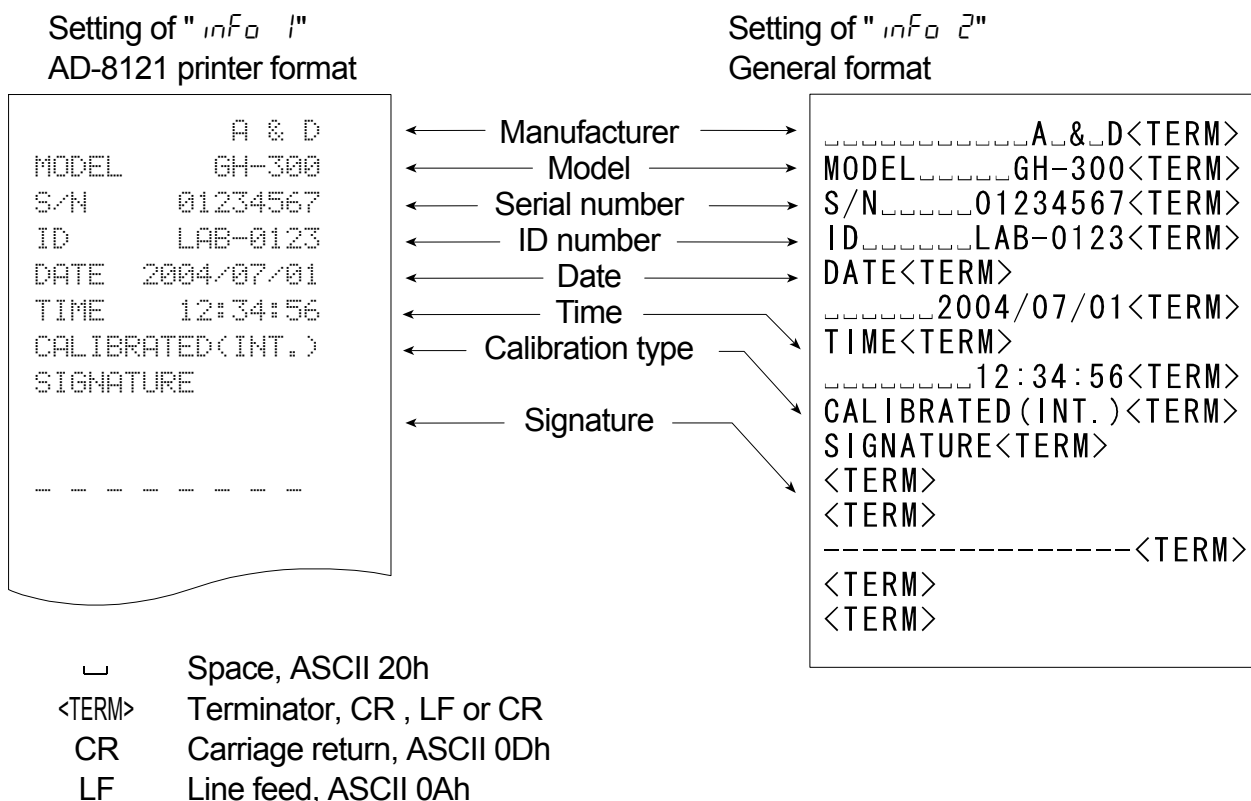

Calibration test report using an internal mass

Note Calibration test does not perform calibration.

Key operation

- 1 Press and hold the `[CAL]` key (for approx. 2 seconds) to display `[EE in]` and release the key.
- 2 `[EE]` is displayed and the balance is tested automatically.
- 3 The zero point is measured and the weight value is displayed for a few seconds.
- 4 Internal mass is weighed and the weight value is displayed for a few seconds.
- 5 If GLP output is used, `[GLP]` is displayed and the calibration test report is output.
- 6 The balance returns to weighing mode after this test.

Commad

This calibration test report can be performed with commad TST.

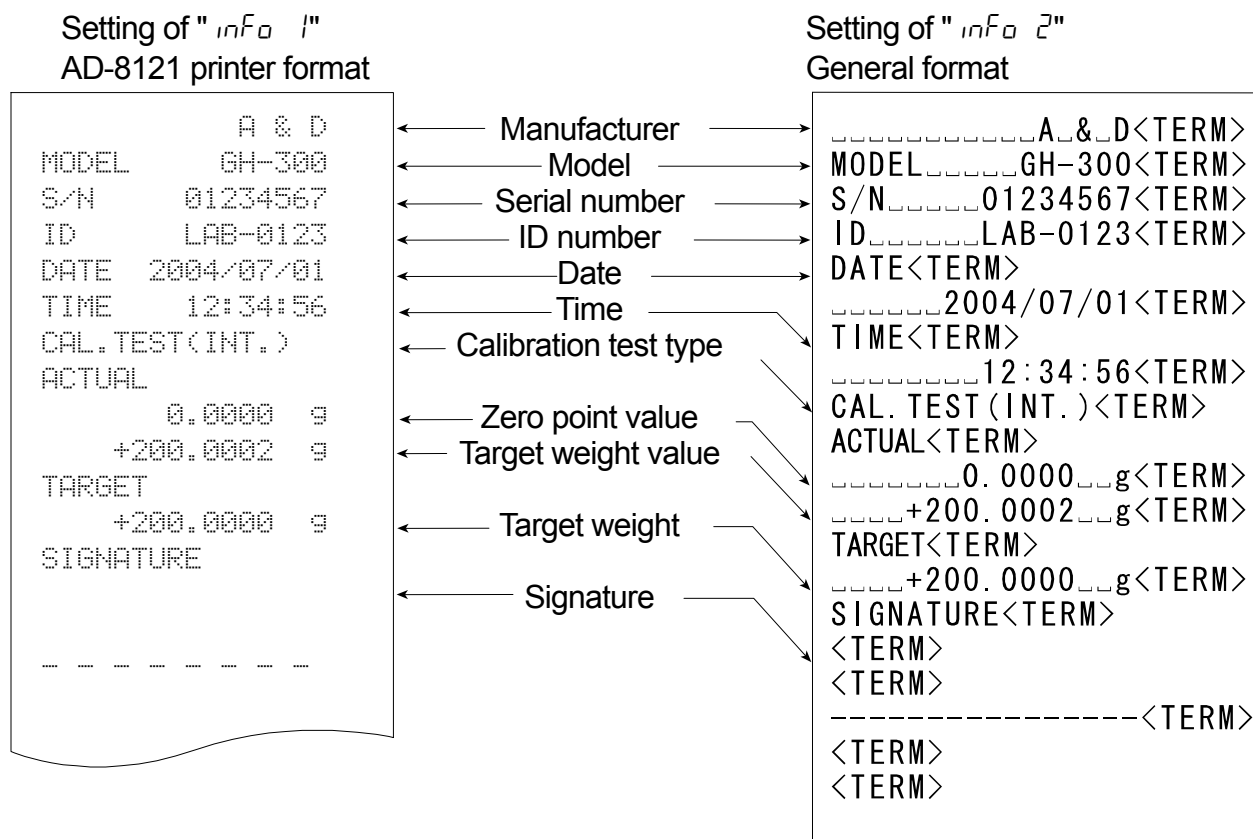

- └ Space, ASCII 20h
- <TERM> Terminator, CR, LF or CR
- CR Carriage return, ASCII 0Dh
- LF Line feed, ASCII 0Ah

Calibration report using an external weight

Key operation

- 1 Press and hold the **[CAL]** key (for approx. 2 seconds) to display **[CAL out]** and release the key.
- 2 **[CAL 0]** is displayed.
- 3 When updating the calibration mass value, press the **[RANGE]** key and proceed to step 4. When using preset calibration mass value, proceed to step 5.
- 4 Specify calibration mass value using the following keys.
 - [RANGE]** key The key to select the blinking figure
 - [RE-ZERO](+)**key .. The key to increase the value of the blinking figure.
 - [MODE](-)**key The key to decrease the value of the blinking figure.
 - [PRINT]** key The key to store the new value.
- 5 When pressing the **[RE-ZERO]** key, the zero point is measured and the weight value is displayed for a few seconds.
- 6 Place the displayed mass on the pan. Press the **[PRINT]** key to measure the mass and the weight value is displayed for a few seconds.
- 7 If GLP output is used, **[GLP]** is displayed and the calibration report is output.
- 8 The balance returns to weighing mode after this calibration.

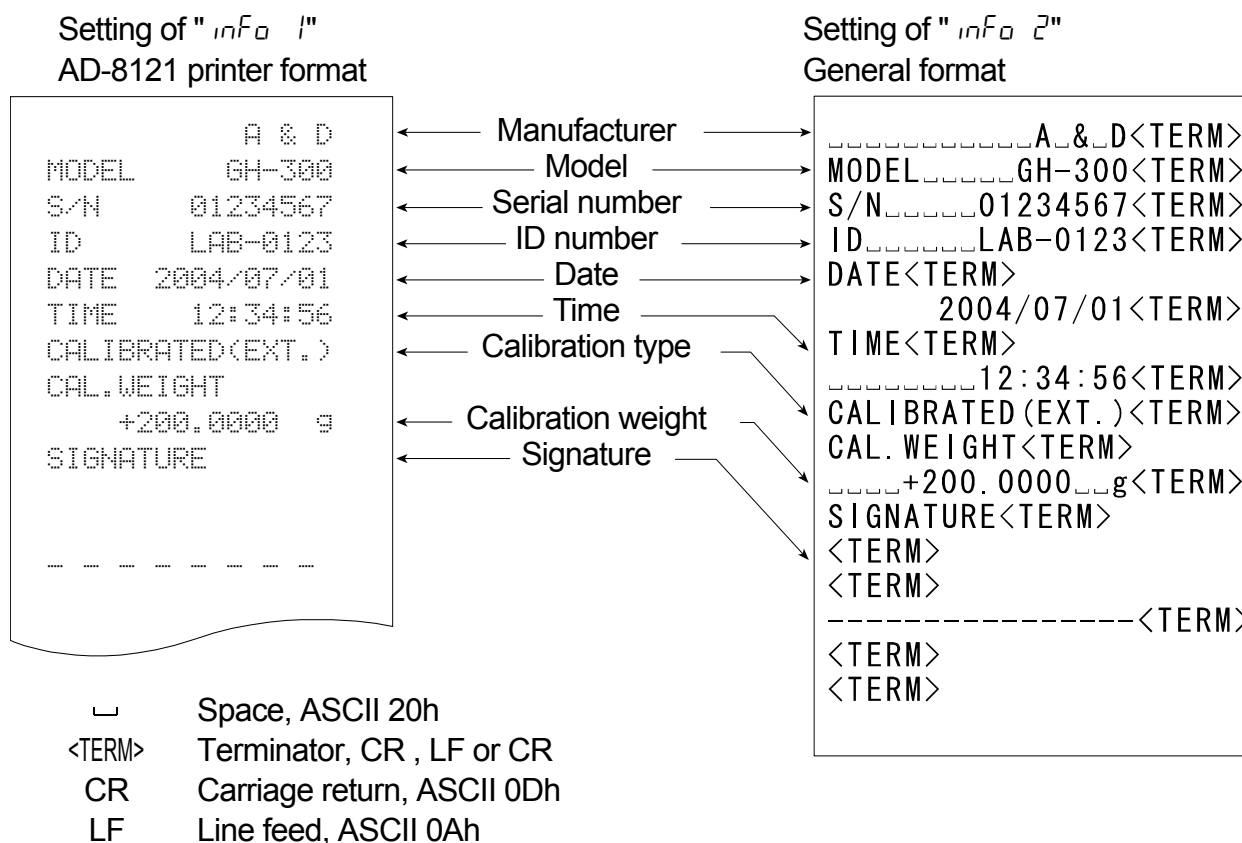

Calibration test report using an external weight

Note Calibration test does not perform calibration.

Key operation

- 1 Press and hold the **[CAL]** key (for approx. 2 seconds) to display **[EE out]** and release the key.
- 2 **[CAL 0]** is displayed.
- 3 When updating the target value, press the **[RANGE]** key and proceed to step 4.
When using preset target value, proceed to step 5.
- 4 Specify calibration mass value using the following keys.
[RANGE] key The key to select the blinking figure
[RE-ZERO](+)key .. The key to increase the value of the blinking figure.
[MODE](-)key The key to decrease the value of the blinking figure.
[PRINT] key The key to store the new value.
- 5 When pressing the **[RE-ZERO]** key, the zero point is measured and the weight value is displayed for a few seconds.
- 6 Place the displayed mass on the pan. Press the **[PRINT]** key to measure the mass and the weight value is displayed for a few seconds.
- 7 If GLP output is used, **[GLP]** is displayed and the calibration test report is output.
- 8 The balance returns to weighing mode after this test.

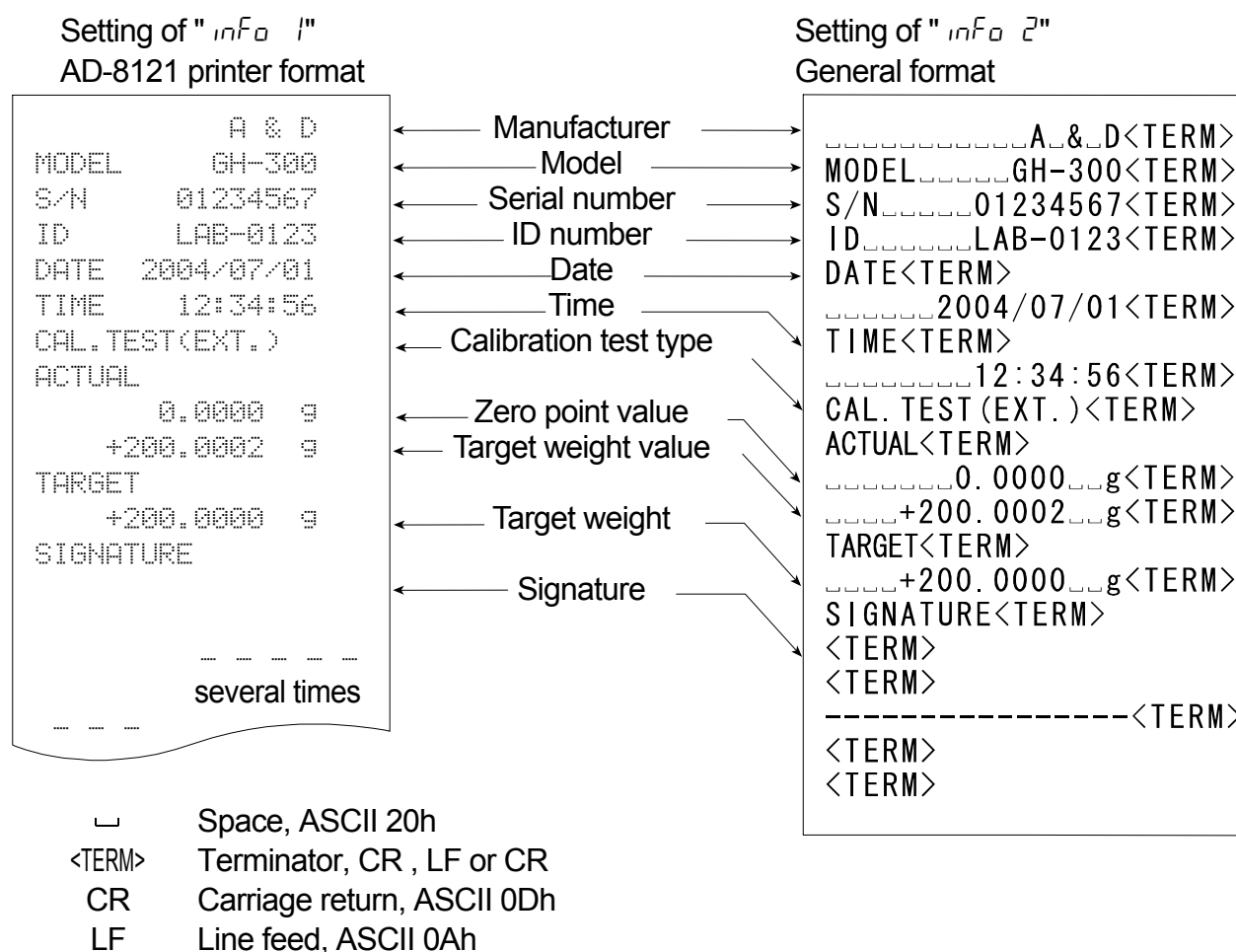

Title block and end block

When mass values are recorded as GLP data, a "Title block" is inserted at the beginning and an "End block" is inserted at the end of a group of mass values in the GLP report.

Notes

- To output the report to an AD-8121B, use MODE 3 of the AD-8121B. If MODE1 is used, select temporary dump print mode by pressing the **STAT.** key of the AD-8121B.
- If the data memory function is used (except *DATA 0*), the "Title block" and "End block" can not be output.

Key operation

- 1 With the weighing data displayed, press and hold the **PRINT** key (for approx. 2 seconds), then release the key. **Start** is displayed. The "Title block" is output.
- 2 The weighing data is output according to the parameter setting of the data output mode (*Print*) of the function table.
- 3 Press and hold the **PRINT** key (for approx. 2 seconds) until **recEnd** is displayed, then release the key. The "End block" is output.

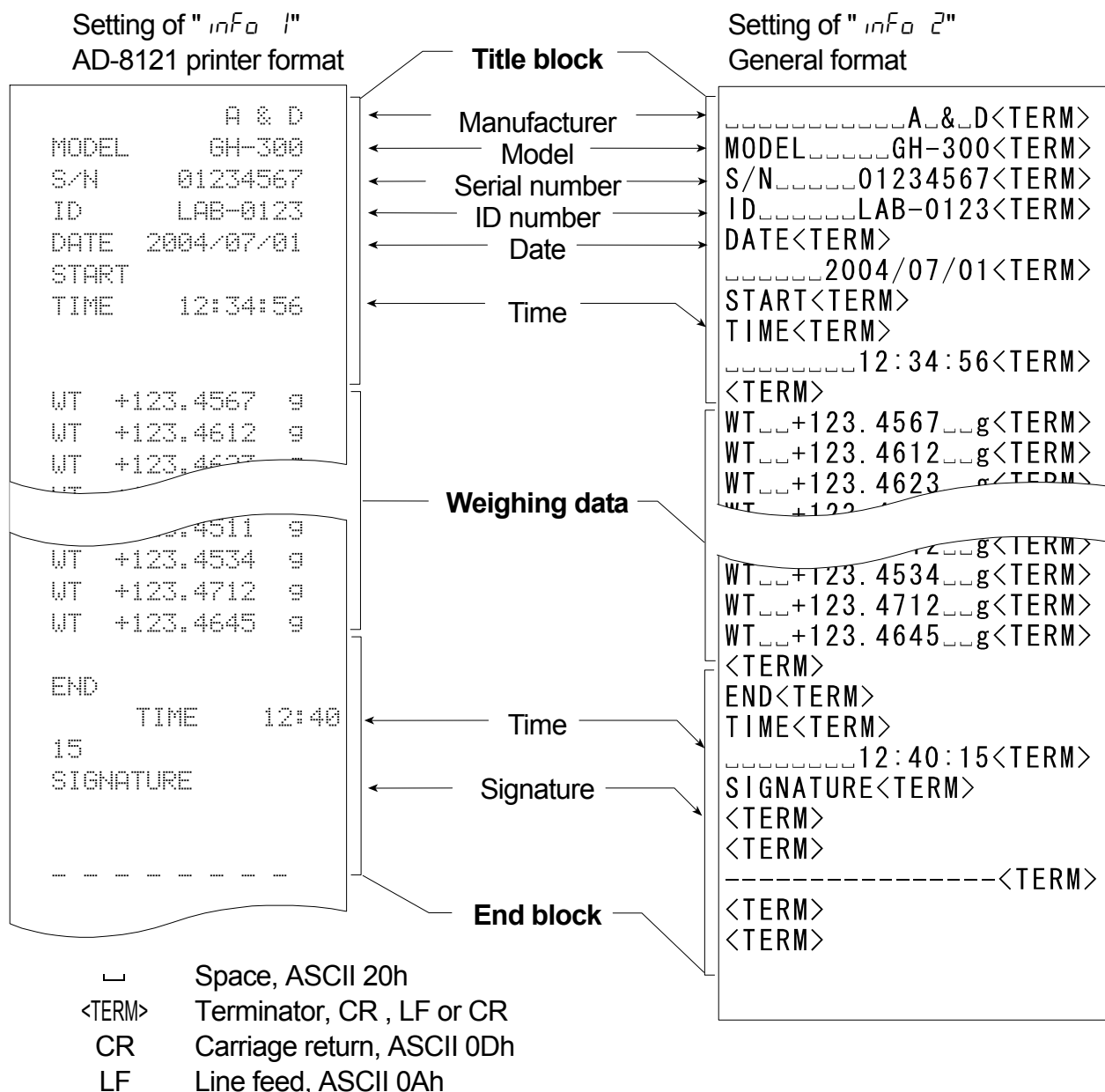

12. Data Memory

Data memory is a function to store weighing data and calibration data in memory. The data stored in memory are available for outputting at one time to a printer or personal computer.

Weighing data	Excluding date and time	Up to 200 sets
	Including date and time	Up to 100 sets
Calibration report Internal calibration External calibration Calibration test report Internal test calibration External test calibration		Last 50 sets

12.1. Notes on Using Data Memory

- To use the memory function, set the "Data memory (*dRtR*)" parameter and "Time/Date output (*S-t d*)" parameter of the function table. Refer to "10. The Function Table" for details on setting the data memory.
- For weighing data, the data contents to be stored and the storage capacity depend on the "Time/Date output (*S-t d*)" parameter setting.
- If a different type of data exists in memory, "[Lr]" blinks the upper left of the display. For example, you want to store weighing data but calibration data or unit mass data remains in memory. Under such a condition, before storing data, delete the data in memory as follows:

Upper left of the display

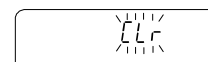

Releasing "[Lr]" or "Err"

- 1 Press and hold the **PRINT** key (for approx. 2 seconds) until **[Lr no]** with "no" blinking is displayed, then release the key.
- 2 Press the **RE-ZERO** key to display **[Lr 00]** with "00" blinking. The type of data stored in memory appears in the upper left of the display as shown below:

Weighing data without time and date	-d-
Weighing data with time and date	d-t
Calibration report	HIS

- 3 Press the **PRINT** key to delete all the data in memory.
- 4 The balance displays **[End]** and returns to the weighing mode.

12.2. Data Memory for Weighing Data

- The balance can store 200 sets of weighing data in memory (if time and date are added, the balance can store 100 sets). Even if the AC adapter is removed, the data is maintained in non-volatile memory.
- It is not necessary to connect the printer or personal computer to the balance continually, because the balance stores the weighing data in memory.
- The data in memory can be output at one time to a printer or personal computer.
- The data in memory can be displayed on the balance for confirmation.
- Data (ID number, data number, time and date) to be added to the output data can be selected in the function setting.

Storing the weighing data

Note If "Lr" blinks in the upper left of the display, delete the data in memory.

- 1 Set the "Data memory (dAtA)" parameter to "1".
- 2 Specify the "Time/Date output (S-t-d)" parameter whether time and date is to added or not.
- 3 The storing mode depends on the "Data output mode (P-r-t)" parameter setting. Four types of storing modes are available to store data.

Key mode When the key is pressed and the displayed value is stable, the balance stores the weighing data.

Auto print modes A When the displayed value is stable and the conditions of "Auto print polarity", "Auto print difference" and zero point (reference value) are met, the balance stores the weighing data.

Auto print modes B When the displayed value is stable and the conditions of "Auto print polarity", "Auto print difference" and last stable data (reference value) are met, the balance stores the weighing data.

Interval memory mode Weighing data is stored at an interval specified in "Interval time (int)". Press the key to start and stop this mode.

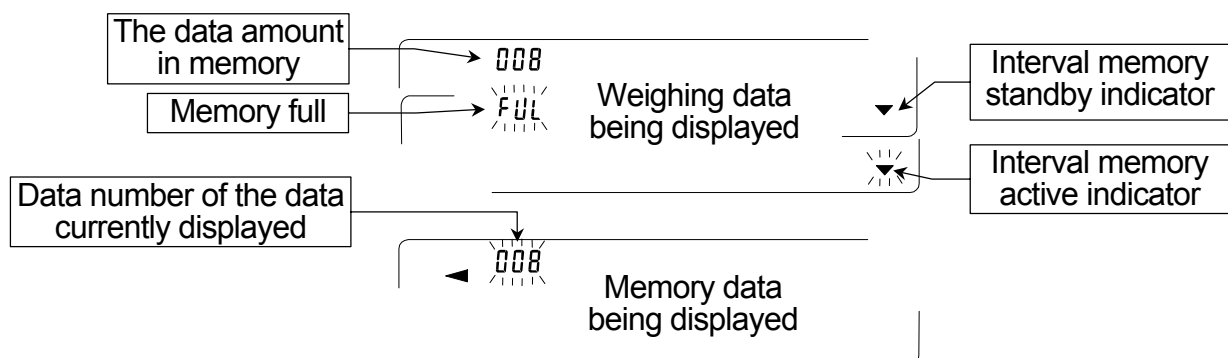

Caution

- When weighing data is being stored in memory, the data can not be output to a personal computer using the RS-232C interface.
- "FUL" indicates that memory is full or the memory capacity has been reached. More data can not be stored unless the memory data is deleted.

- Automatic self calibration can not be used while the interval memory mode is active.
- The following commands can not be used during data storage.
 - Q Query command for weighing data.
 - S Query command for stable weighing data.
 - SI Query command for weighing data.
 - SIR Query command for continuous weighing data.

Setting the function table

Parameter settings for each output mode are as follows:

Mode \ Item	Data output mode	Auto print polarity, difference	Data memory function	Interval time
Key mode	<i>Prt 0</i>	Not used	<i>dAtA 1</i>	Not used
Auto print mode A	<i>Prt 1</i>	<i>AP-A 0-2</i>	<i>dAtA 1</i>	
Auto print mode B	<i>Prt 2</i>	<i>AP-b 0-2</i>	<i>dAtA 1</i>	
Interval memory mode	<i>Prt 3</i>	Not used	<i>dAtA 1</i>	<i>int 0-8</i>

Additional parameter settings, as follows:

Data number	No	<i>d-no 0</i>	Time and date	No	<i>S-td 0</i>
	Yes	<i>d-no 1</i>		Time only	<i>S-td 1</i>
ID number	No	<i>S-id 0</i>		Date only	<i>S-td 2</i>
	Yes	<i>S-id 1</i>		Both	<i>S-td 3</i>

Enabling the data memory function

- 1 Press and hold the **RANGE** key (for approx. 2 seconds) until **bASFnC** is displayed, then release the key.
- 2 Press the **RANGE** key several times to display **dout**.
- 3 Press the **PRINT** key.
- 4 Press the **RANGE** key three times to display **dAtA 0**.
- 5 Press the **RE-ZERO** key to display **dAtA 1**.
- 6 Press the **PRINT** key to store the setting.
- 7 Press the **CAL** key to return to the weighing mode.

Recalling the memory data

Confirm that the "Data memory (dAtA)" parameter is set to "I".

- 1 Press and hold the **PRINT** key (for approx. 2 seconds) until **rECALL** is displayed, then release the key.
- 2 Press the **PRINT** key to enter the memory recall mode. The type of data appears in the upper left of the display as shown to the right. Recall the data in memory using the following keys.
 - RE-ZERO** key..... To proceed to the next data set.
 - MODE** key To go back to the previous data set.
 - PRINT** key To transmit the current data using the RS-232C interface.

With **RANGE** held down, press the **CAL** key
To delete the current data.

CAL key..... To exit the memory recall mode.
- 3 Press the **CAL** key to return to the weighing mode.

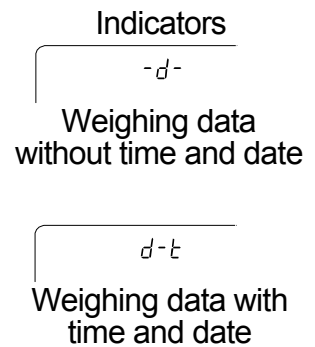

Transmitting all memory data at one time

Confirm that the "Serial interface (SIF)" parameters are set properly.

Refer to "10. Function Table" and "15.2. Connection To Peripheral Equipment".

- 1 Press and hold the **PRINT** key (for approx. 2 seconds) until **rECALL** is displayed, then release the key.
- 2 Press the **RANGE** key to display **out**.
- 3 Press the **PRINT** key to display **out no** with "no" blinking.
- 5 Press the **RE-ZERO** key to display **out Go** with "Go" blinking.
- 6 Press the **PRINT** key to transmit all data using the RS-232C interface.
- 7 The balance displays **CLER** when all data is transmitted.
Press the **CAL** key to return to the weighing mode.

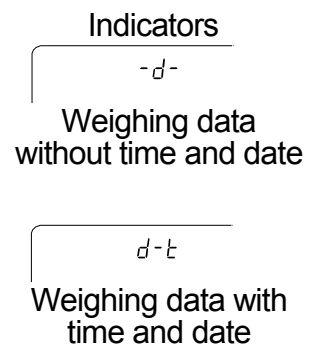

Deleting all memory data at one time

- 1 Press and hold the **PRINT** key (for approx. 2 seconds) until **rECALL** is displayed, then release the key.
- 2 Press the **RANGE** key several times to display **CLER**.
- 3 Press the **PRINT** key to display **CLr no** with "no" blinking.
- 4 Press the **RE-ZERO** key to display **CLr Go** with "Go" blinking.
- 5 Press the **PRINT** key to delete all data
- 6 The balance displays **End** and returns to the weighing mode.

12.3. Data Memory for Calibration and Calibration Test

- Calibration data (when and how it is performed) and calibration test data can be stored in memory.
- All the data in memory is available to be output at one time to a printer or personal computer.
- Up to 50 data sets of the latest calibration or calibration test can be stored. When the memory capacity has been reached, "FUL" illuminates in the upper left of the display as shown below.

Indicator



FUL

Storing the calibration and calibration test data

Note If "CLR" appears blinking in the upper left of the display, delete the data in memory.

Store the calibration and calibration test data as follows:

- 1 Set the "Data memory (dAtA)" parameter to "2".
- 2 Set the "GLP output (inF0)" parameter to "1" or "2".
- 3 With the settings above, each time calibration or calibration test is performed, the data is stored automatically.

Transmitting the memory data

Note

- Confirm that the "Serial interface (SIF)" parameters are set properly. Refer to "10. Function Table" and "15.2. Connection To Peripheral Equipment".
- Confirm that the "Data memory (dAtA)" parameter is set to "2".

- 1 Press and hold the **PRINT** key (for approx. 2 seconds) until **out** is displayed, then release the key.
- 2 Press the **PRINT** key to display **out no** with "no" blinking.
- 3 Press the **RE-ZERO** key to display **out 00** with "00" blinking.
- 4 Press the **PRINT** key to transmit all memory data using the RS-232C interface.
- 5 The balance displays **CLEAR** when all memory data is output. Press the **CAL** key to return to the weighing mode.

In the upper left of the display



H15

Deleting data stored in memory

- 1 Press and hold the **PRINT** key (for approx. 2 seconds) until **out** is displayed, then release the key.
- 2 Press the **SAMPLE** key to display **CLEAR**.
- 3 Press the **PRINT** key to display **Clr no** with "no" blinking.
- 4 Press the **RE-ZERO** key to display **Clr 00** with "00" blinking.
- 5 Press the **PRINT** key to delete all data.
- 6 The balance displays **out** and returns to the weighing mode when all the data has been deleted.

In the upper left of the display



H15

13. Underhook

The underhook can be used for magnetic materials or density measurement. The built-in underhook is revealed by removing the cap on the bottom of the balance. Use the underhook as shown below.

Caution

- Do not apply excessive force to the underhook.
- When not in use, attach the cap to prevent dust from getting into the balance.
- Do not push the underhook upward
- When turning the balance over, the weighing pan, pan support, breeze break ring and dust plate will fall off. Remove them first.
- When the cap is removed, a weighing error may occur, because of drafts entering into the internal portion of the balance. Arrange the room condition.

- 1 Remove the cap on the bottom of the balance.
- 2 Hang your weighing pan on the underhook.
Place the balance on the solid table.

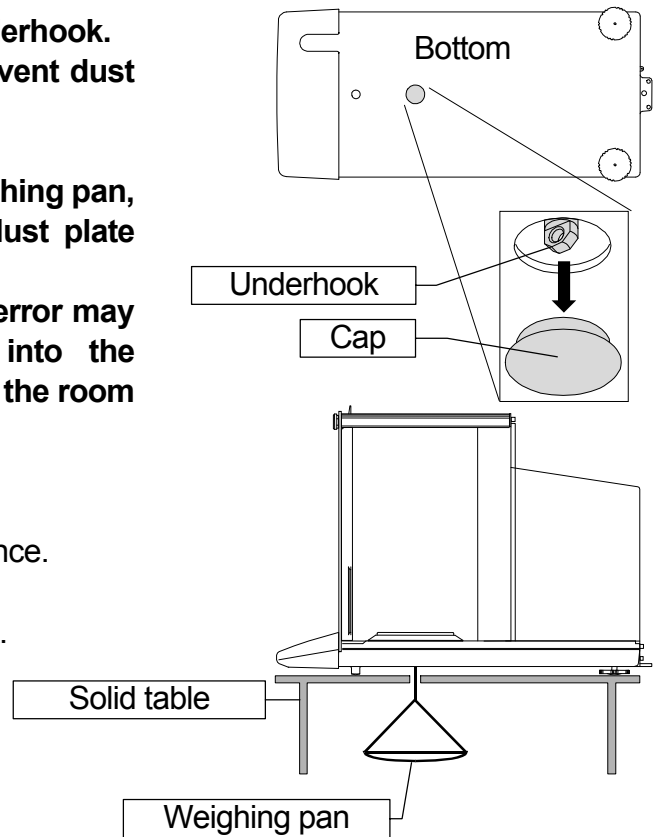

14. Density Measurement

The balance is equipped with a density mode. It calculates the density of a solid using the mass value of a sample in air and the mass value in liquid.

Note

- The density mode was not selected for use when the balance was shipped from the factory. To use the mode, change the function table and activate the density mode.
- When the density mode is selected, the response adjustment function can not be used.
- Readability is 0.0001 g while density mode.

Formula to obtain the density

The density can be obtained by the following formula.

$$\rho = \frac{A}{A - B} \times \rho_0$$

Where

- ρ : Density of a sample
- A : Mass value of a sample in air
- B : Mass value of a sample in liquid
- ρ_0 : Density of a liquid

Prior to measurement: Changing the function table

Prior to measurement, change the function table as follows:

- 1 Selecting the density mode.
The density mode is available as one of the weighing units. Select it by pressing the **MODE** key. To use the mode, select it (unit of **Unit d**.) in the function table. Refer to "5.2. Changing Units".
- 2 Selecting a way to set the density of a liquid.
Select the liquid density input method from the function table below.

Note

The function table is available only when the density mode (*d5FnC*) is selected. *d5FnC* is displayed next *5iF* when density mode is active at *Unit*.

Class	Item and Parameter	Description
<i>d5FnC</i> Density function	<i>LdIn</i>	▪ 0 Water temperature
	Liquid density input	1 Liquid density

▪ is factory setting.

Entering the density of a liquid

Two ways to set the density of a liquid are available in the function table, "Liquid density input (Ld_{in}): by entering the water temperature or by entering the density directly.

- 1 Press the **MODE** key as necessary to select the density mode. When the density mode begins, "g (gram)" is displayed and the processing indicator (◀) blinks.

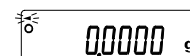

Entering the water temperature (Ld_{in} D)

- 2 The water temperature currently set (unit: °C, factory setting : 25°C) is displayed. Use the following keys to change the value.



RE-ZERO(+)key .. The key to increase the temperature by one degree.
(0°C is displayed after 99°C)

MODE(-)key The key to decrease the temperature by one degree.
(99°C is displayed after 0°C)

PRINT key The key to store new water temperature, display **End** and return to the density mode. Proceed to Step 1.

CAL key The key to cancel the change and return to the density mode.
Proceed to Step 1.

The relation between the water temperature and density

°C	+0	+1	+2	+3	+4	+5	+6	+7	+8	+9
0	0.99984	0.99990	0.99994	0.99996	0.99997	0.99996	0.99994	0.99990	0.99985	0.99978
10	0.99970	0.99961	0.99949	0.99938	0.99924	0.99910	0.99894	0.99877	0.99860	0.99841
20	0.99820	0.99799	0.99777	0.99754	0.99730	0.99704	0.99678	0.99651	0.99623	0.99594
30	0.99565	0.99534	0.99503	0.99470	0.99437	0.99403	0.99368	0.99333	0.99297	0.99259
40	0.99222	0.99183	0.99144	0.99104	0.99063	0.99021	0.98979	0.98936	0.98893	0.98849
50	0.98804	0.98758	0.98712	0.98665	0.98618	0.98570	0.98521	0.98471	0.98422	0.98371
60	0.98320	0.98268	0.98216	0.98163	0.98110	0.98055	0.98001	0.97946	0.97890	0.97834
70	0.97777	0.97720	0.97662	0.97603	0.97544	0.97485	0.97425	0.97364	0.97303	0.97242
80	0.97180	0.97117	0.97054	0.96991	0.96927	0.96862	0.96797	0.96731	0.96665	0.96600
90	0.96532	0.96465	0.96397	0.96328	0.96259	0.96190	0.96120	0.96050	0.95979	0.95906

Entering the density directly (Ld_{in} I)

The density currently set (unit : g / cm^3 , factory setting : $1.0000g / cm^3$) is displayed.

Use the following keys to change the value.

The range to set the density is $0.0000g / cm^3$ to $1.9999g / cm^3$.



RE-ZERO(+)key... The key to set the value of the digit selected.

RANGE(-)key The key to select the digit to change the value.

PRINT key The key to store the change, display **End** and return to the density mode. Proceed to Step 1.

CAL key The key to cancel the change and return to the density mode. Proceed to Step 1.

Measuring the density

Note If the liquid temperature or the type of liquid is changed during measurement, input again the value of the liquid density as necessary.

Density display is four decimal places. Readability can not change with the **RANGE** key.

Density is displayed after "Mass measurement in air" and "Mass measurement in liquid".
The procedure of each measurements is as follows:

1 Enter the density mode that "g (gram)" is displayed and the processing indicator (◀) blinks. Place nothing on both pan and press the **RE-ZERO** key to display zero.

2 Place the sample on the pan in air.
If the weight value is stored or output, press the **PRINT** key to store it after a stable weight value is displayed.
Press the **RANGE** key to decide the weight value in air and proceed to next step.

Note If negative value or E (out of range) is displayed, the **RANGE** key is inactive.

3 Move the sample to the pan in liquid.
If the weight value is stored or output, press the **PRINT** key to store it after a stable weight value is displayed.
Press the **RANGE** key to decide the weight value in liquid and proceed to next step.

Note If E (out of range) is displayed, the **RANGE** key is inactive.

4 If the density value is stored or output, press the **PRINT** key to store it.
Press the **RANGE** key to measure other sample and proceed to step 2.

5 If the liquid temperature or the type of liquid is changed during measurement, input again the value of the liquid density as necessary.

6 Press the **MODE** key to proceed to other modes.

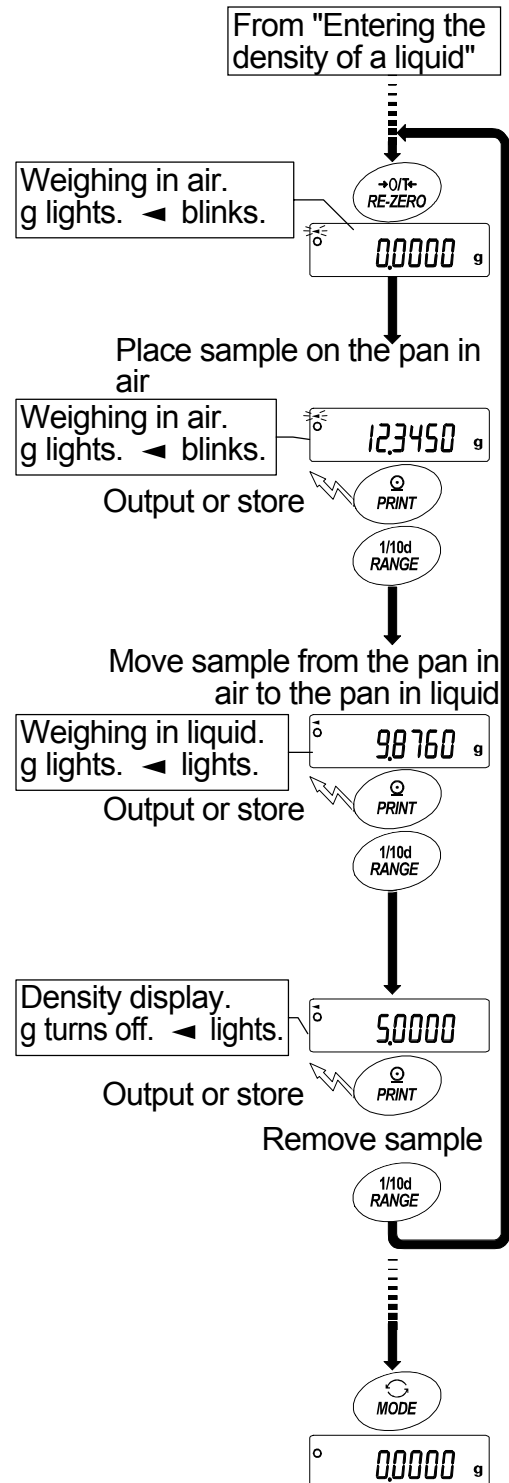

15. Standard Input and Output Interface

15.1. RS-232C Interface

The balance is a DCE device. Connect the balance to a personal computer (DTE) using a straight through cable.

- Transmission system : EIA RS-232C
- Transmission form : Asynchronous, bi-directional, half duplex
- Transmission rate : 10 times/second or 5 times/second (same as data refresh rate)
- Data format : Baud rate : 600, 1200, 2400, 4800, 9600, 19200bps
- Data bits : 7 or 8 bits
- Parity : Even, Odd (Data bits 7 bits)
- None (Data bits 8 bits)
- Stop bit : 1 bit
- Code : ASCII

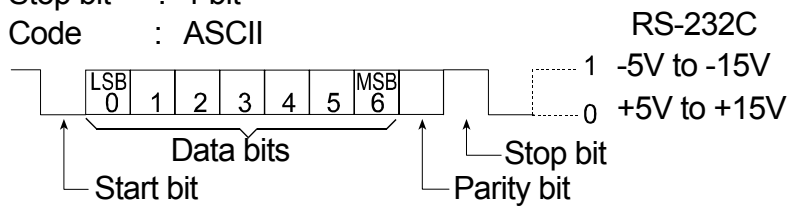

D-Sub 25 pin assignments

Pin No.	Signal name	Direction	Description
1	-	-	No connection
2	RXD	Output	Transmit data
3	TXD	Input	Receive data
4	-	-	No connection
5	SG	-	Signal ground
6	DSR	Output	Data set ready
7	RTS	Input	Request to send
8	CTS	Output	Clear to send
9	-	-	No connection

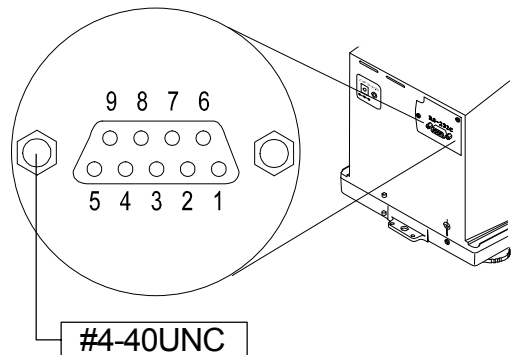

All signal names mean name for the DTE side.

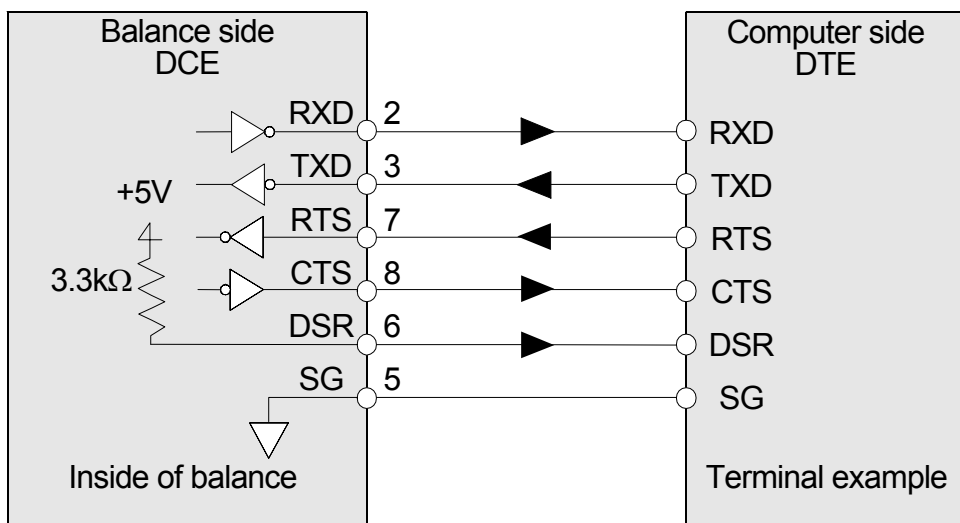

15.2. Connection to Peripheral Equipment

Connection to an AD-8121B printer

Preset the following parameters to use the AD-8121B printer.

Class	Item and Parameter	Factory settings	AD-8121B MODE 1	AD-8121B MODE 2	AD-8121B MODE 3
dout Data output	<i>Prt</i> Data output mode	0	0,1,2	3	0,1,2
	<i>AP-P</i> Auto print polarity	0	#1	Not necessary	#1
	<i>AP-b</i> Auto print difference	1			
	<i>d-no</i> Data number output	0	0	0	0,1
	<i>S-td</i> Time/Date output	0	0	0	0,1,2,3
	<i>S-id</i> ID number output	0	0	0	0,1
	<i>PUSE</i> Data output pause	0	0	0	0,1 #2
	<i>AE-F</i> Auto feed	0	0	0	0,1
SIF Serial interface	<i>bPS</i> Baud rate	2	2	2	2
	<i>bPr</i> Data bit, parity bit	0	0	0	0
	<i>TrLF</i> Terminator	0	0	0	0
	<i>TYPE</i> Data format	0	0	0	1
	<i>CTS</i> CTS, RTS control	0	0	0	0

#1 Set parameters when auto print mode A or B (*Prt* 1 or 2) is selected.

#2 Set 1 when multiple lines are printed. Example: When appending ID number, set 1.

Notes

- Refer to "11.2. GLP Report" concerning print samples.
- Settings of AD-8121B

MODE	AD-8121B DIP switch	Description
MODE 1		Print at receiving data. Standard mode, statistic mode
MODE 2		Print by DATA key operation or built-in timer. Standard mode, interval mode, chart mode
MODE 3		Print at receiving data. Dump print mode

DIP switch No.3 : Handling unstable data

ON Print

OFF Not printed

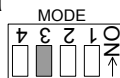

DIP switch No.4 : Data input specifications (Interface selection)

ON Current loop

OFF RS-232C

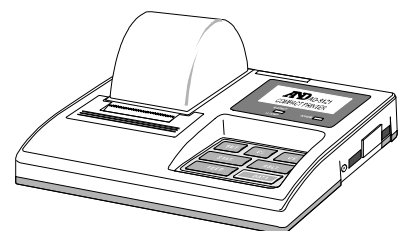

Connecting to the AD-8127 Printer

When connecting the AD-8127 printer to the balance for printing weighing data, configure the printer and the balance as follows according to the usage examples.

Function settings of the printer

Usage example	AD-8127 Multi printer Printing mode settings
When printing the balance weighing data with the balance's PRINT key or its "Auto print" mode.	EXT.KEY
When printing the balance weighing data with the printer's "Printing" key or its "Interval printing" mode. When printing charts with the printer.	MANUAL AUTO TIMER CHART
When printing the balance's GLP report.	DUMP

- Refer to the instruction manual of the AD-8127 printer for how to change the function settings of the AD-8127 printer.

Function settings of the balance

Usage example	Balance <i>Prt</i> Data output mode	Balance <i>tYPE</i> Data format
When printing the balance weighing data with the balance's PRINT key or its "Auto print" mode.	0, 1, 2	0
When printing the balance weighing data with the printer's "Printing" key or its "Interval printing" mode. When printing charts with the printer.	3	0
When printing the balance's GLP report.	0, 1, 2	1

- Refer to "10. Function Table" for how to change the function settings of the balance.

Connecting to a Computer Using the RS-232C Interface

Features

The balance is of the DCE type (Data Communication Equipment), which can be connected to a personal computer using the RS-232C interface. Before connection, read the personal computer manual thoroughly. Use a standard DCE cable for connection (cable type: straight-through).

Using Windows Communication Tools Software (WinCT)

When Windows is used as an operating system in a personal computer, the WinCT software can be used to transmit the weighing data to the personal computer. The current version of the WinCT can be downloaded from the A&D website. Confirm the windows version supported by this software when downloading. Refer to the WinCT instruction manual in the A&D website. The WinCT software has three communication methods: "RsCom" , "RsKey" and "RsWeight".

RsCom

- RsCom can transmit commands to control the balance.
- RsCom can make bi-directional communication between the balance and a personal computer using the RS-232C interface.
- RsCom can display or store the data using a text file format. RsCom can also print the data using a printer connected to the personal computer.
- When several ports of a personal computer have balances connected, the personal computer can communicate with each balance simultaneously.
- RsCom can share a personal computer with other application software.
- RsCom can receive the balance GLP report.

RsKey

- RsKey can transmit the weighing data output from the balance directly to other application software such as Microsoft Excel.
- RsKey can be used with most application software.
- RsKey can receive the balance GLP report.

RsWeight

- Can retrieve the weight data from the balance and display the data as a graph in real time.
- Can calculate and display the maximum, minimum, average, standard deviation and coefficient of variation.

Using the WinCT software, the balance can do the following:

- **Analyzing the weighing data and the statistics input by "RsKey"**
The weighing data can be input directly into an Excel worksheet. Then, Excel can analyze the data to obtain total, average, standard deviation, maximum and minimum values, and display them in a graph.
- **Controlling the balance using commands from a personal computer**
By using "RsCom", the personal computer sends commands such as "re-zero" or "send weighing data" to the balance and controls the balance.
- **Printing the balance GLP report using your printer**
The balance GLP report can be printed using a printer connected to the personal computer.
- **Receiving weighing data at a certain interval**
The weighing data can be received at a certain interval and data characteristic with elapsed time can be obtained.
- **Using the balance memory function**
The data can be stored in the balance's memory. Of the data stored, the weighing data and calibration data can be transmitted to a personal computer at one time.
- **Using a personal computer as an external indicator**
With the "RsKey" test mode function, a personal computer can be used as an external weight indicator for the balance. (To do this, set the balance data output mode to stream mode.)

15.3. Commands

15.3.1. Command List

Note A command has a terminator added, that is specified using "S IF CRLF" of the function table, and is sent to the balance.

Commands to query weighing data	
C	Cancels the S or SIR command.
Q	Requests the weighing data immediately.
S	Requests the weighing data when stabilized.
SI	Requests the weighing data immediately.
SIR	Requests the weighing data continuously.

Commands to control the balance	
CAL	Same as the <input type="button" value="CAL"/> key.
OFF	Turns the display off.
ON	Turns the display on.
P	Same as the <input type="button" value="ON:OFF"/> key
PRT	Same as the <input type="button" value="PRINT"/> key
R	Same as the <input type="button" value="RE-ZERO"/> key ^(Note 1)
RNG	Same as the <input type="button" value="RANGE"/> key.
TR	Tares the balance (Cancels the container's weight.) ^(Note 1)
TST	Perform calibration test.
U	Same as the <input type="button" value="MODE"/> key

Commands to request data	
?ID	Requests the identification number.
?PT	Outputs the tare value. ^(Note 1)
?SN	Request the serial number of the balance.
?TN	Request the model name of the balance.

Command to set data	
PT:***.**** <input type="button" value="g"/>	Sets the tare value. ^(Note 1)

- (Note 1)**
- R command assumes the point as zero and sets the display to zero.
 - TR command cancels the tare weight when the displayed value is greater than zero. The canceled tare value can be read using the ?PT command.
 - PT: command sets the tare value digitally.
An example of this command sets a negative target value and fills with the sample until the display becomes zero.
 - Step 1 Place a container.
 - Step 2 Set the display to zero using the R command.
 - Step 3 Set a target value using the PT: command.
 For details, refer to page 72.

15.3.2. Acknowledge Code and Error Codes

When the "Serial interface function (S_{IF})" parameter is set to "ErCd 1", the balance outputs <AK> code or error code to each command as follows:

<AK> (06h) Acknowledge in ASCII code.

- When the balance receives a command to request data and can not process it, the balance transmits an error code (EC, E_{xx}).

When the balance receives a command to request data and can process it, the balance outputs the data.

- When the balance receives a command to control the balance and can not process it, the balance transmits an error code (EC, E_{xx}).

When the balance receives a command to control the balance and can process it, the balance transmits the acknowledge code.

Among commands to control the balance, the following transmit the acknowledge code both when the balance receives the command and when the balance has accomplished the command. If the command can not be processed properly, the balance transmits an error code (EC, E_{xx}). This error can be released using the CAL command.

CAL command (Calibration command using internal mass)

ON command (Display ON command)

P command (Display ON/OFF command)

R command (RE-ZERO command)

TR command (Tare command)

TST command (Calibration test command)

- When a communication error has occurred due to external noise, or a parity error has occurred due to transmission error, the balance transmits an error code. In this case, send the command again.

xx is error code number.

15.3.3. Control Using CTS and RTS

Depending on the "CTS" parameter of "Serial interface (S_{IF})", the balance performs as follows:

CTS 0

Regardless of whether the balance can receive a command or not, the balance keeps the CTS line Hi. The balance outputs data regardless of the condition of the RTS line.

CTS 1

The CTS line is kept Hi normally. When the balance can not receive the next command (Example: while the balance is processing the last command), the balance sets the CTS line to Lo. The balance confirms the level of the RTS line before outputting a set of data. If the RTS level is Hi, the balance outputs data. If the RTS level is Lo, data is not output (The data is canceled).

15.3.4. Settings Related to RS-232C

Concerning the RS-232C, the balance has two functions: "Data output (d_{out})" and "Serial interface (S_{IF})". Set each function as necessary.

15.3.5. Command Examples

This example uses the "ErCd" of "SIF" so that the <AK> (06h) code is output.

ON command (turning on the balance)

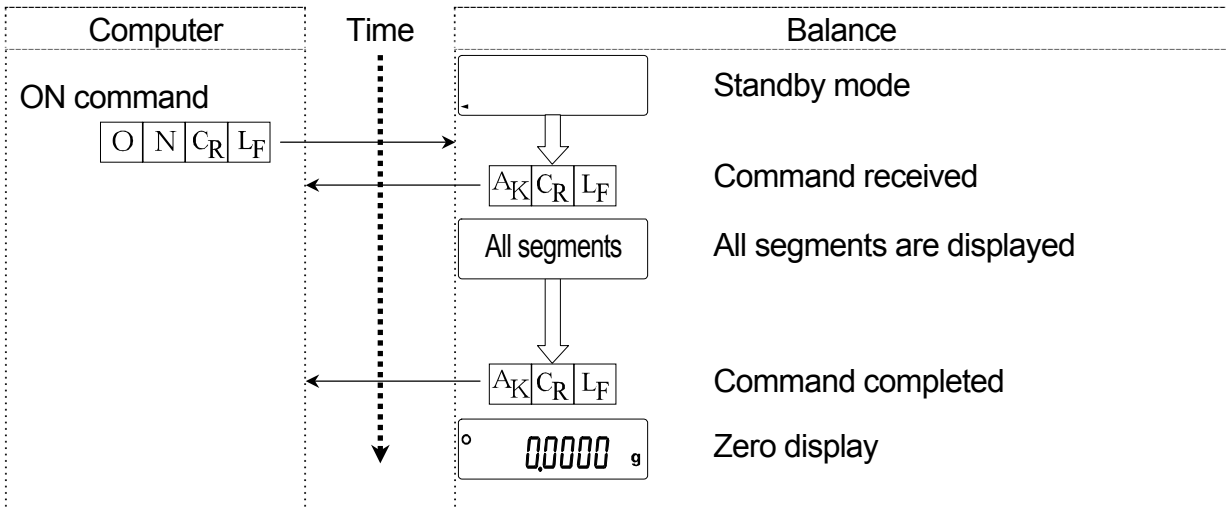

R command (Re-zeroing the display)

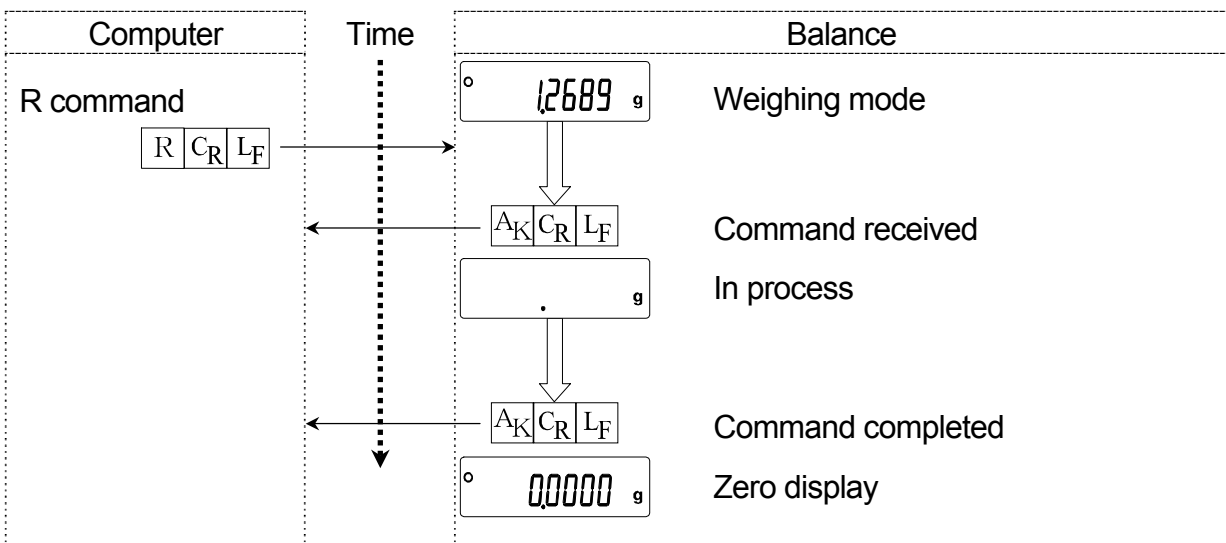

CAL command (Calibration with internal mass)

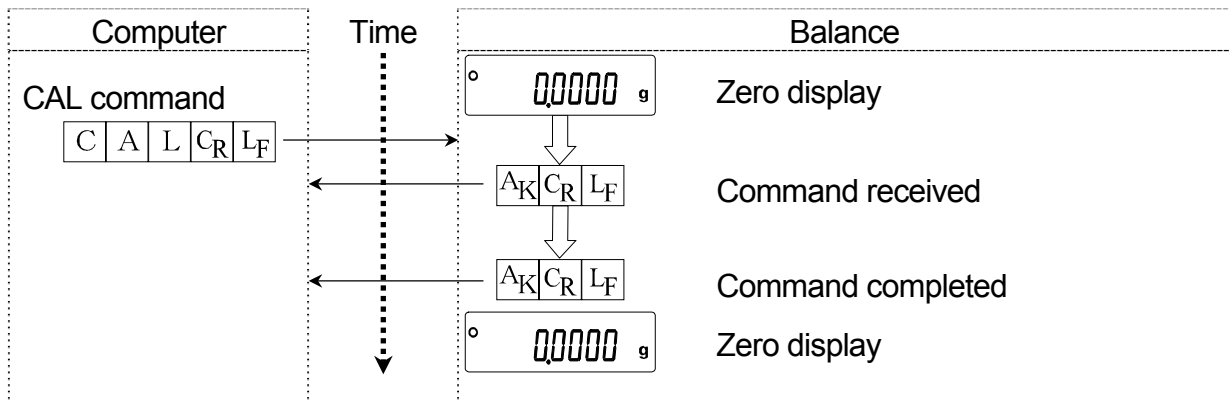

Error code

This example is of an error using the R command. "Error 1" is used. The balance transmits an error code when the received command can not be achieved.

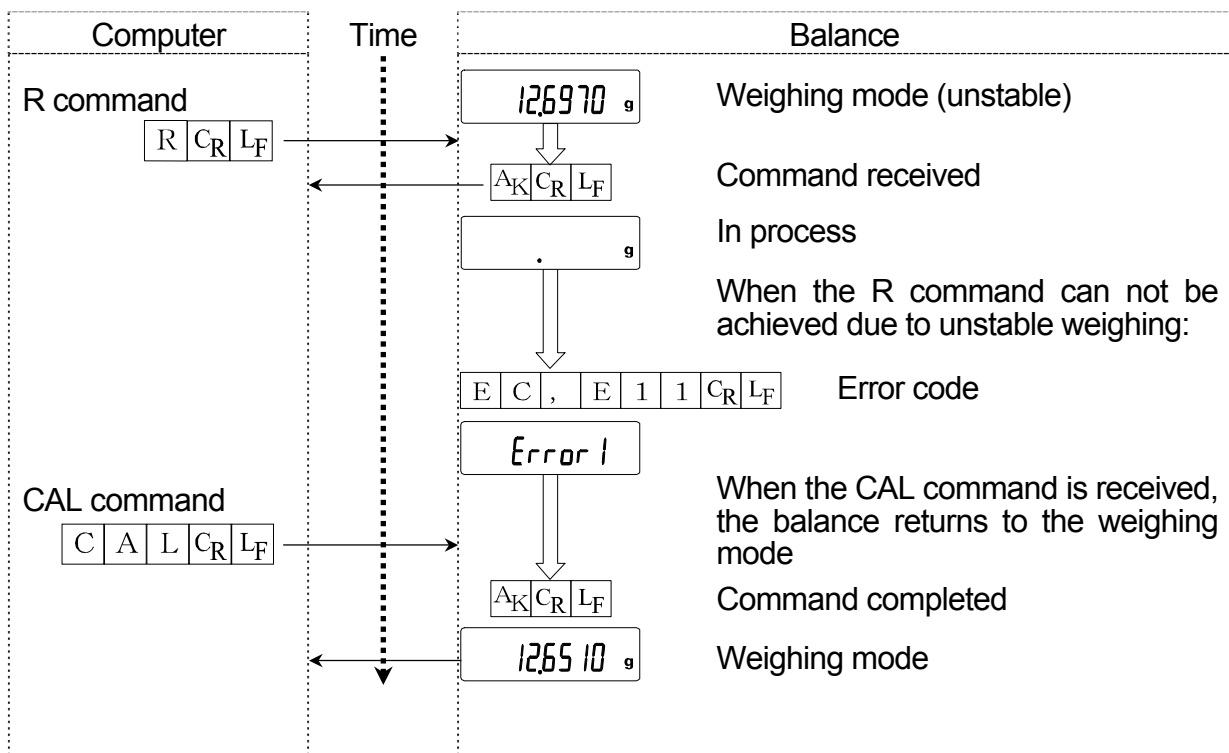

Weighing with a tare

This example uses "ErCd" of "S rF" so that the <AK> (06h) code is output.

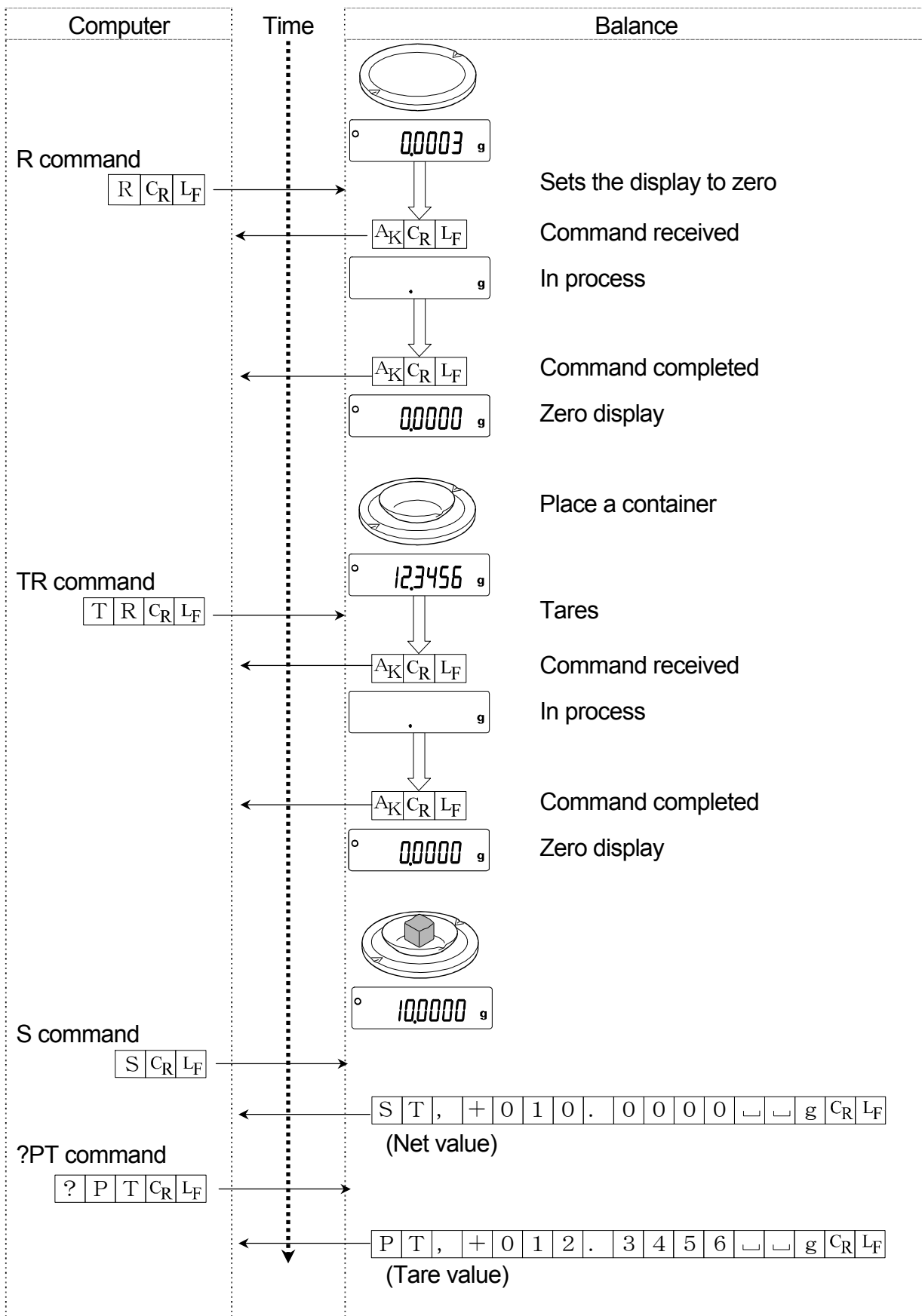

Setting a negative target value and filling with a sample until the display becomes zero

This example uses "Erld l" of "S rF" so that the <AK> (06h) code is output.

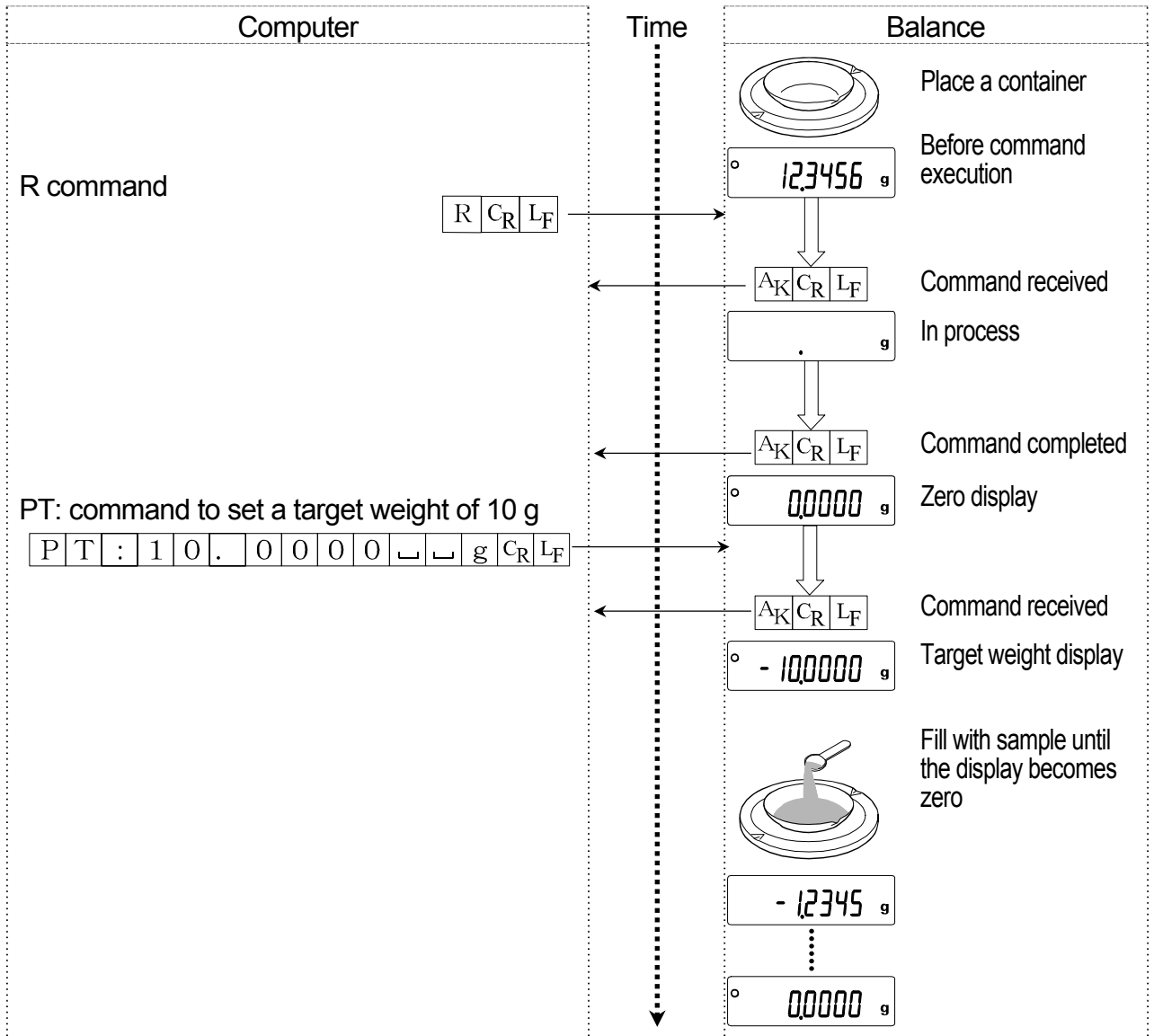







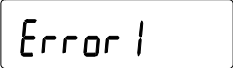

16. Maintenance

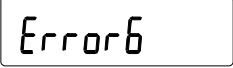
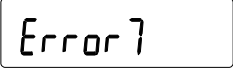
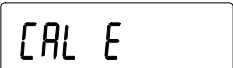
16.1. Treatment of the Balance

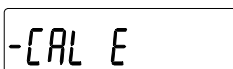
- Clean the balance with a lint free cloth that is moistened with warm water and a mild detergent.
- Do not use organic solvents to clean the balance.
- Do not disassemble the balance. Contact the local A&D dealer if the balance needs service or repair.
- Use the original packing material for transportation.
- Consider "3. Precautions" when operation the balance.

16.2. Error Codes

Display	Error code	Description
	EC,E11	Stability error The balance can not stabilize due to an environmental problem. Check around the pan. Prevent vibration, drafts, temperature changes, static electricity and magnetic fields, from influencing the balance. To return to the weighing mode, press the  key.
	EC,E16	Internal mass error Applying the internal mass does not yield a change in the mass value as specified. Confirm that there is nothing on the pan and perform the weighing operation from the beginning again.
	EC,E17	Internal mass error The internal mass application mechanism does not function properly. Perform the weighing operation from the beginning again.
	EC,E20	Calibration weight error The calibration weight is too heavy. Confirm the calibration mass value. Press the  key to return to the weighing mode.
	EC,E21	Calibration weight error The calibration weight is too light. Confirm the calibration mass value. Press the  key to return to the weighing mode.
		Overload error A sample beyond the balance weighing capacity has been placed on the pan. Remove the sample from the pan.
		Weighing pan Error The mass value is too light. Confirm that the weighing pan is properly installed and calibrate the balance.

Display	Error code	Description
		Sample mass error The balance can not store the sample for the counting mode or for the percent mode because it is too light. Use a larger sample.
		Unit mass error The sample unit mass for the counting mode is too light. Storing and using it for counting will cause a counting error. Add samples to reach the specified number and press the PRINT key. Pressing the PRINT key without adding samples will shift the balance to the counting mode. But, for accurate counting, be sure to add samples.
		Automatic response adjustment zero error The automatic response adjustment can not be performed because there is something on the pan. Clear the pan. Press the CAL key to return to the weighing mode.
 (Check NG)		Automatic response adjustment unstable error The automatic response adjustment can not be performed because the mass value is unstable. Check the ambient conditions such as breeze, vibration and magnetic fields, also check the weighing pan. Press the CAL key to return to the weighing mode.
		Clock battery error The clock backup battery has been depleted. Press any key and set the time and date. The clock and calendar function works normally as long as the AC adapter is connected to the balance. If this error appears frequently, contact the local A&D dealer.
		Low battery error Voltage of the power supply drops. Confirm whether the correct AC adapter is used.
		Memory full The amount of weighing data in memory has reached the maximum capacity. Delete data in memory to store new data. For details, refer to "12. Data Memory".
		Memory full The amount of calibration or calibration test data in memory has reached the maximum capacity (50 sets). The data in memory will be deleted automatically to store new data. For details, refer to "12. Data Memory".
		Memory type error Type of memory set in the function table and type of data stored are different. For details, refer to "12. Data Memory".
		Memory data error The stored data were destroyed. To use the memory function, erase all the old data and release the error. For details, refer to "12.1. Notes on Using Data Memory".

Display	Error code	Description
	EC,E00	Communications error A protocol error occurred in communications. Confirm the format, baud rate and parity.
	EC,E01	Undefined command error An undefined command was received. Confirm the command.
	EC,E02	Not ready A received command can not be processed. Example: <ul style="list-style-type: none"> □ The balance received a "Q" command, but not in the weighing mode. □ The balance received a "Q" command while processing a RE-ZERO command. Adjust the delay time to transmit a command.
	EC,E03	Timeout error If the timeout parameter is set to "t-UP l", the balance did not receive the next character of a command within the time limit of one second. Confirm the communication.
	EC,E04	Excess characters error The balance received excessive characters in a command. Confirm the command.
	EC,E06	Format error A command includes incorrect data. Example: <ul style="list-style-type: none"> □ The data is numerically incorrect. Confirm the command.
	EC,E07	Parameter setting error The received data exceeds the range that the balance can accept. Confirm the parameter range of the command.
Other error code		If an error described above can not be released or other errors are displayed, contact the local A&D dealer.

16.3. Other Display

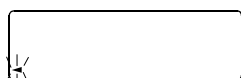

Advise

When this indicator blinks, automatic self calibration is required. The indicator blinks when the balance detects changes in ambient temperature. If the balance is not used for several minutes with this indicator blinking, the balance performs automatic self calibration. The blinking period depends on the operating environment.

The balance can be used while this indicator is blinking. We recommend that you perform automatic self calibration for precision weighing.

16.4. Checking the Balance Performance and Environment

The balance is a precision instrument. When the operating environment or the operating method is inadequate, correct weighing can not be performed. Place a sample on the pan and remove it, and repeat this several times. If the balance seems to have a problem with repeatability or to perform improperly, check as described below. If improper performance persists after checking, contact the local A&D dealer for repair.

Checking that the operating environment or weighing method is proper

Operating environment

- Is the weighing table solid enough?
- Is the balance level?
- Is the operating environment free from vibration and drafts?
- Is there a strong electrical or magnetic noise source such as a motor near the balance?

Weighing method

- Does the weighing pan rim touch anything? Is the weighing pan assembly installed correctly?
- Is the **RE-ZERO** key pressed before placing a sample on the weighing pan?
- Is the sample placed in the center of the weighing pan?
- Is the fine range breeze break ring installed for weighing with a readability of 0.01 mg for the GH-252 and GH-202?
- Has the balance been calibrated using the internal mass (one-touch calibration)?
- Has the balance been warmed up for one hour before weighing?

Sample and container

- Has the sample absorbed or lost moisture due to the ambient conditions such as temperature and humidity?
- Has the temperature of the container been allowed to equalize to the ambient temperature?
- Is the sample charged with static electricity?
- Is the sample of magnetic material such as iron? There are cautions about weighing magnetic materials.

Checking that the balance performs properly

- Check the balance performance using an external weight. Be sure to place the weight in the center of the weighing pan.
- Check the balance repeatability, linearity and calibrated value using external weights with a known value.

16.5. Asking for Repair

If the balance needs service or repair, contact your local A&D dealer.

The balance is a precision instrument. Use much care when handling the balance and observe the following when transporting the balance.

- Use the original packing material for transportation.
- Remove the weighing pan, pan support, breeze break ring and dust plate from the main unit.

17. Specifications

	GH-120	GH-200	GH-300	GH-202	GH-252
Weighing capacity	120 g	220 g	320 g	220 g	250 g
				51 g	101 g
Maximum display	120.0084 g	220.0084 g	320.0084 g	220.0084 g	250.0084 g
				51.00009 g	101.00009 g
Readability	0.1 mg			0.1 mg	
				0.01 mg	
Repeatability (Standard deviation)	0.1 mg		0.2mg	0.1 mg	
				0.02 mg	0.03 mg
Linearity	±0.2 mg		±0.3 mg	±0.2 mg	
				±0.03 mg	±0.10 mg
Stabilization time (Typical at FAST)	Approx. 3.5 seconds			Approx. 3.5 seconds	
				Approx. 8 seconds	
Sensitivity drift, 10°C to 30°C / 50°F to 86°F	±2 ppm/°C				
Operating environment	5°C to 40°C, 85%RH or less (No condensation)				
Display refresh rate	5 times/second or 10 times/second				
Counting mode	Minimum unit mass	0.1 mg			
	Number of samples	10, 25, 50 or 100 pieces			
Percent mode	Minimum 100% reference mass	10.0 mg			
	% readability	0.01 %, 0.1 %, 1 % (Depends on the reference mass stored.)			
Interface	RS-232C				
External calibration weight	100g 50g	200g 100g	300g 200g 100g	200g 100g 50g 20g	
Weighing pan	φ90 mm				
External dimensions	217(W) x 442(D) x 316(H) mm				
Power supply & AC adapter type	Power consumption: Approx. 11VA (supplied to the AC adapter) Confirm that the adapter type is correct for the local voltage and power receptacle type.				
Mass	Approx. 8.2 kg				

- The operating environment does not include excessive change of ambient temperature, humidity, vibration, drafts, magnetic fields and static electricity.
- The internal mass may change due to corrosion or other damage caused by the operating environment, or due to aging. Check the internal mass periodically and correct the internal mass value if necessary.

17.1. External Dimensions

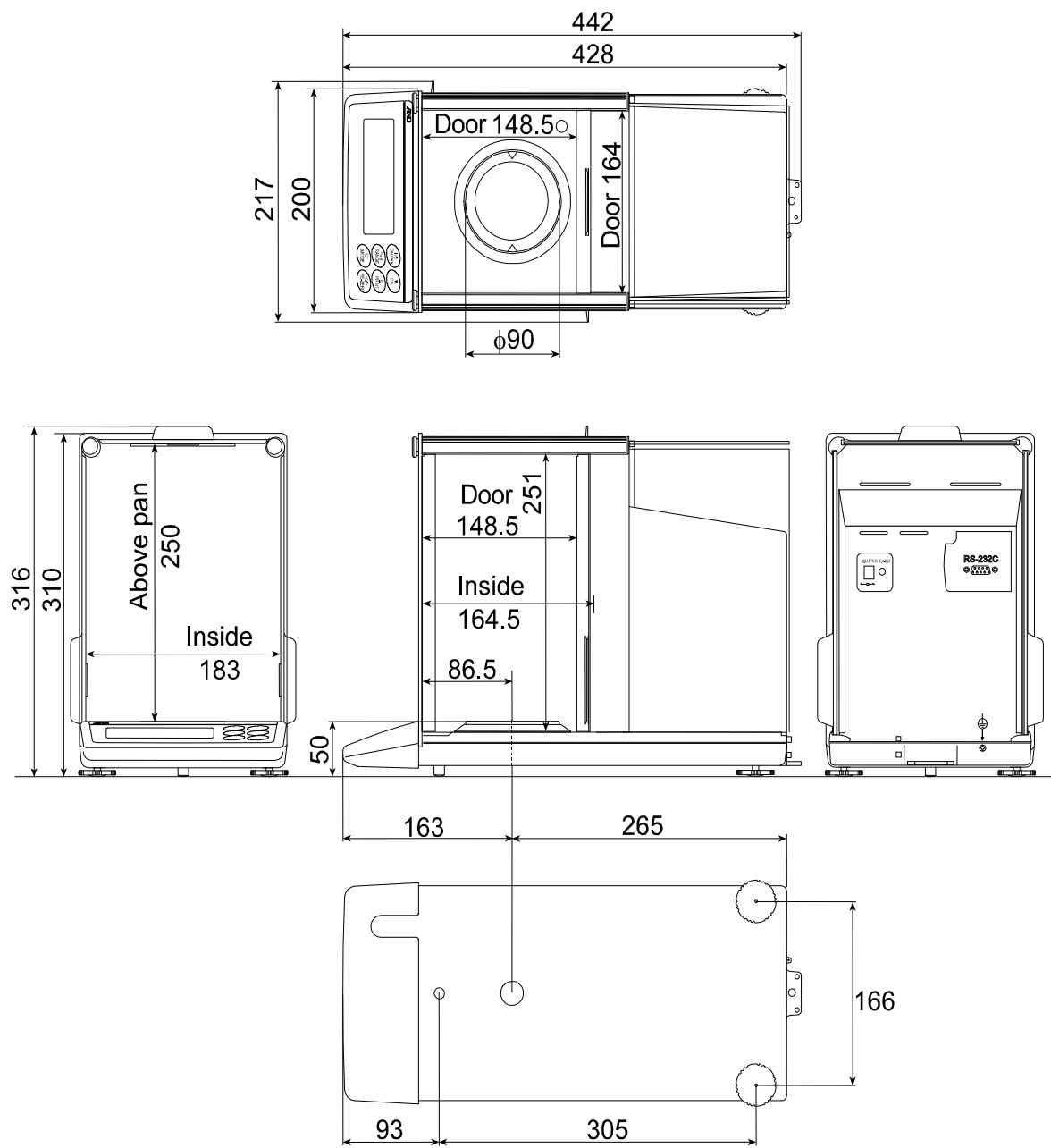

Unit: mm

17.2. Options and Peripheral Equipment

GH-02 USB interface

- The interface to connect a balance to a personal computer, and is used to transmit the balance weight data to the personal computer via USB. Applicable OS is Windows 98 or later.
- As the Windows standard driver is used to transmit the weighing data, complicated installation of a dedicated driver is not necessary.
- The balance weighing data can be transmitted to applications such as Excel, Word and memo pad for Windows automatically.
- To perform bi-directional communications using WinCT or to output GLP data to a personal computer by using the personal computer USB interface, use the AX-USB-9P USB converter.

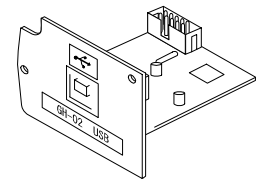

GH-08 Ethernet Interface

- The interface to connect the balance to a LAN.
- Accessory: The "WinCT-Plus" data communication software.
 - The software can acquire data from multiple balances connected to a LAN.
 - The software can control these balances with commands.
 - The software can acquire data transmitted from balances. Example: When pressing the **PRINT** key of the balance, data is output and is acquired by the computer.
 - The stored data can be used with Microsoft EXCEL (if installed).

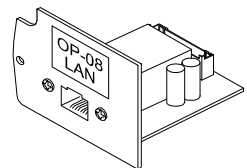

The screenshot shows the RsMulti software interface. On the left, there are controls for manual/repeat testing, command data selection, and connection name selection. The main area displays a table of data for two balances, GH-252 and GH-300, over 12 rows of measurements. The table columns are: Row, Time, Status, Weight, Unit, Time, Status, Weight, Unit.

	GH-252				GH-300			
1	11:19:43	ST	+018.2252	g	11:20:02	ST	+019.2181	g
2	11:19:49	ST	+018.2253	g	11:20:05	ST	+019.2182	g
3	11:21:07	ST	+018.2955	g	11:20:12	ST	+019.2182	g
4	11:21:12	ST	+018.2964	g	11:20:39	ST	+019.2898	g
5	11:21:17	ST	+018.2965	g	11:20:47	ST	+019.2182	g
6	11:21:33	ST	+018.6676	g	11:23:02	ST	+019.2184	g
7	11:21:41	ST	+018.2251	g	11:23:09	ST	+019.2180	g
8	11:21:51	ST	+018.2251	g	11:23:16	ST	+019.2180	g
9	11:22:00	ST	+018.2965	g				
10	11:22:30	ST	+018.2265	g				
11	11:22:33	ST	+018.2252	g				
12	11:22:40	ST	+018.2239	g				

AD-1653 Density Determination Kit

$$\frac{\text{Weigh in air}}{\text{Weigh in water} - \text{Weigh in the air}} \times \text{water density} = \text{sample density}$$

Example

$$\frac{10.0000 \text{ g}}{10.0000 \text{ g} - 9.5334 \text{ g}} \times 0.9970 \text{ g/cm}^3 = 21.4 \text{ g/cm}^3$$

Temperature	Water density
0°C	0.99984 g/cm ³
10°C	0.99970 g/cm ³
20°C	0.99820 g/cm ³
30°C	0.99565 g/cm ³

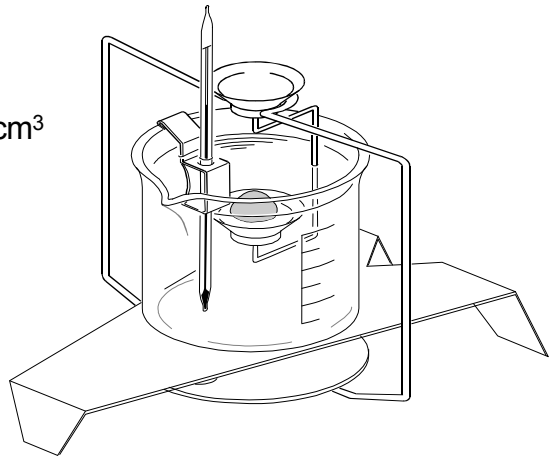

Option

AD-8127: Multi printer

- Small dot impact printer that connects to the balance via the RS-232C interface.
- Statistical calculation mode, calendar/clock function, interval printing mode, chart printing mode, dump printing mode

AD-1691: Balance environment analyzer

- During the routine inspection, repeatability and the readability can be easily checked.
- Also, this calculates measurement uncertainty and supports environmental evaluation of the balance.
- This analyzer can be easily carried to the balance site, so more than one balance can be controlled using this analyzer.

AD-1687: Weighing environment logger

- A data logger equipped with 4 sensors for temperature, humidity, barometric pressure and vibration that can measure and store environmental data. When connected to the RS-232C interface of the balance, the AD-1687 can store environmental data along with weighing data. Therefore, it is possible to store data in an environment where a computer cannot be used.
- The stored data can be read to a personal computer using USB. As the AD-1687 is recognized as USB memory, special software is not required to read the data.

AD-1688: Data logger

- When connected to the RS-232C interface of the balance, the AD-1688 can store the data in an environment where a personal computer cannot be used.

AD-8526: Ethernet converter

- This option can be used to connect the RS-232C interface of the balance to the Ethernet (LAN) port of a computer. This allows management of the balance weighing data with a computer connected to a network.

AD-8527: Quick USB adapter

- This option transmits the weighing data directly to software applications such as Excel and Word.

AD-8920A: Remote display

- Connected to the balance using the RS-232C interface.

AD-8922A: Remote controller

- This option can be connected to the balance using the RS-232C interface and can control the balance remotely. Various options such as comparator output or analog output are available.

AX-USB-9: USB converter

- Adds a COM port to a personal computer.
- Enables bi-directional communication between the personal computer and the balance when a USB driver is installed.
- Can use serial communication software such as WinCT on a personal computer without COM ports.
- An RS-232C cable is provided to connect the USB converter to the balance.

AD-1671: Anti-vibration table

- Approximately 27 kg, Artificial stone (Terrazzo).
- Use this table when unstable weighing is caused by vibration coming from the floor.
- Use the AD-8922A remote controller to avoid a weighing error by a slight table tilt that key operation may make.

AD-1672/AD-1672A Tabletop breeze break (Large)

- Large sized table breeze break
- Protects the balance from wind from sources such as air conditioning or people passing by, thereby reducing balance weighing errors.
- The transparent panel assembly consists of antistatic plastic material that protects the balance from static electricity.
- Samples can be inserted or removed through the opening on the front.
- AD-1672: 680 (W) x 600 (D) x 720 (H) mm, AD-1672A: 680 (W) x 584 (D) x 720 (H) mm

AD-1676: Tabletop breeze break (Medium)

- A tabletop breeze break of a size best suited for the BM / GH / HR-*i* series balances.
- Protects the balance from wind from sources such as air conditioning or people passing by, thereby reducing balance weighing errors.
- The transparent panel assembly consists of antistatic plastic material that protects the balance from static electricity.
- Sliding panels on the right and left side enable samples to be inserted or removed from each side.
- 368(W) x 514(D) x 350(H) mm (Including the handle)

AD-1682: Rechargeable Battery

- This option allows use of the balance in a place where AC power is not available.

AD-1683: DC static eliminator

- This static eliminator eliminates static electricity to prevent weighing errors caused by static electricity during measurement.
- This direct current and windless type of eliminator is the most suitable for precisely weighing powder, etc.
- Small size, light weight

AD-1684A: Electrostatic field meter

- This option measures the amount of the static charge on the sample, tare or peripheral equipment and displays the result.
- If those are found to be charged, discharge them using the AD-1683 DC static eliminator.

AD-1689: Tweezers for calibration weight

- A pair of tweezers ideally suited for holding calibration weights of 1 g to 500 g.

AD-8529PC-W: Bluetooth converter (for connecting a personal computer)*

- This option connects a personal computer to the balance wirelessly (via Bluetooth®) up to 10 m.
- Driver installation is required.

AD-8529PR-W: Bluetooth converter (for connecting a printer)*

- This option connects a printer to the balance wirelessly (via Bluetooth®) up to 10 m.

***Note on the AD-8529PC-W and AD-8529PR-W**

The two products may require certification for compliance with local laws pertaining to radio broadcast and equipment for wireless communication. Please refer to the A&D website for countries where the products are already certified for use.

AX-KO5363-30: Connection cable for a weighing device with D-sub25 pin

- The AD-8529PC-W or AD-8529PR-W (Bluetooth converter) can be connected to the GH series balances using this optional cable.

AX-SW137-PRINT: Foot switch print function with a plug

- The foot switch has the same function as the key.

AX-SW137-REZERO: Foot switch rezero function with a plug















- The foot switch has the same function as the key.

18. Terms/Index

18.1. Terms

Calibration	Adjustment of the balance so that it can weigh accurately.
Calibration weight	A weight used for calibration
Data number	Numbers assigned sequentially when weighing data or unit weight is stored.
Digit	The readability available. Used for the balance, one digit is the smallest mass that can be displayed.
Environment	Ambient conditions such as vibration, drafts, temperature, static electricity and magnetic fields which affect the weighing operation.
External weight	The weight that you have.
GLP	Good Laboratory Practice.
GMP	Good Manufacturing Practice
Internal mass	Built-in calibration weight
ISO	International Organization for Standardization
Repeatability	Variation in measured values obtained when the same mass is placed and removed repetitively. Usually expressed as a standard deviation. Example: Standard deviation = 1 digit: This means that measured values, obtained when the same sample is placed and removed repetitively, fall within ± 1 digit in the frequency of about 68%.
Re-zero	To set the display to zero.
Sensitivity drift	An affect that a change in temperature causes to the weighing data. Expressed as a temperature coefficient. Example: Temperature coefficient = 2 ppm/ $^{\circ}\text{C}$: If a load is 10 g and the temperature changes by 10°C , the value displayed changes by the following value. $0.0002\%/^{\circ}\text{C} \times 10^{\circ}\text{C} \times 10\text{g} = 0.0002\text{ g}$
Stabilization time	Time required after a sample being placed, until the stabilization indicator illuminates and the weighing data is displayed.
Tare	To cancel the mass value of a container which is not to be included in the weighing data. Normally, refers to an operation of placing a container and setting the display to zero.
Target mass	An external weight used for calibration test
Zero point	A weighing reference point. Usually refers to the value displayed when nothing is on the weighing pan.

18.2. Index

- % Unit of percent mode 22
-  CAL key 12, 33
-  MODE key 12
-  ON/OFF key 12
-  PRINT key 12, 33
-  RANGE key 12, 33
-  RE-ZERO key 12, 33
-  Data number 12, 43, 55
-  Interval memory mode 12, 55
-  Prior notice indicator 12, 26
-  Process indicator 12
-  RESPONSE [FAST] [MID] [SLOW] Response indicator 12
-  Space mark.. 44, 49, 50, 51, 52, 53
-  Stabilization indicator 12, 18, 33
-  Standby indicator 12
- A&D format 41
- AC adapter 6, 77
- ACAI Function 21
- AD-1653 Density determination kit 80
- AD-1671 Anti-vibration table 81
- AD-1672/AD-1672A Tabletop breeze break .. 81
- AD-1676 Tabletop breeze break 81
- AD-1682 Rechargeable battery 81
- AD-1683 DC Static Eliminator 81
- AD-1684A Electrostatic field meter 81
- AD-1687 Weighing environment logger 80
- AD-1688 Data logger 80
- AD-1689 Tweezers for calibration weight.. 82
- AD-1691 Weighing environment analyzer. 80
- AD-8121B Printer 80
- AD-8127 Printer 80
- AD-8526 Ethernet Converter 80
- AD-8527 Quick USB Adapter 80
- AD-8529PC-W Bluetooth Converter 82
- AD-8529PR-W Bluetooth Converter 82
- AD-8920A Remote display 80
- AD-8922A Remote controller 81
- AK code 68
- AP-b* Auto print difference 36, 40, 64
- AP-P* Auto print polarity 36, 40, 64
- Ar-d* Zero after output 37
- At-F* Auto feed 37, 64
- AX-KO5363-30 82
- AX-SW137-PRINT Foot switch for print 82
- AX-SW137-REZERO Foot switch for re-zero 82
- AX-USB-9P-EX USB converter 81
- bASFnC* Environment display 33, 36
- bPS* Baud rate 37, 64
- btPr* Data bit, parity bit 37, 64
- CS in* Internal mass correction 30
- CAL E* Calibration weight error 73
- CAL E* Calibration weight error 73
- CAL in* One-touch calibration 26
- CAL out* Calibration using an external weight 28
- Calibration 25, 29, 83
- Calibration test 25
- CC in* Calibration test 27
- CC out* Calibration test 29
- CH 0* Response error 74
- CL Add* Clock 36
- CLr* Initializing the balance 32
- Cond* Condition 23, 36, 39
- CrLF* Terminator 37, 64
- CS in* Internal mass correction 38
- CSV format 43
- CTS* CTS, RTS control 38, 64
- CTS 68
- d-* Weighing data with calender 54
- dARA* Data memory 36
- Data number 83
- Digit 83
- d-no* Data number output 37
- dout* Data output 36, 37, 40
- dS Fnc* Density function 38
- d-t* Weighing data 54
- Dump print 41
- E* Weighing pan Error 73
- E* Overload error 73
- EC,E00 Communications error 75
- EC,E01 Undefined command error 75
- EC,E02 Not ready 75
- EC,E03 Timeout error 75
- EC,E04 Excess characters error 75
- EC,E06 Format error 75
- EC,E07 Parameter setting error 75
- EC,E11 Stability error 73
- EC,E16 Internal mass error 73
- EC,E17 Internal mass error 73
- EC,E20 Calibration weight error 73
- EC,E21 Calibration weight error 73
- ErEd* AK, Error code 38
- Error 1* Stability error 73
- Error 6* Internal mass error 73
- Error 7* Internal mass error 73
- Error code 73
- External weight 25, 83
- FAST 23
- FCC 4
- FULL* Memory full 55, 58, 74
- GH-02 USB interface 79
- GH-08 Ethernet Interface 79
- GLP 83
- GMP 83
- HiS* Calibration report 54

<i>id</i>	ID number setting	38	<i>RsWeight</i>	66
ID Number	43, 48	<i>rtc</i>	Clock battery error	74
<i>info</i>	GLP output.....	37	RTS	68
<i>int</i>	Interval time	37	<i>S-id</i>	ID number output.....	37, 64
KF format	42	<i>S-if</i>	Serial interface	37
<i>Ldin</i>	Liquid density input.....	38	SLOW	23
<i>Lo</i>	Sample mass error	74	<i>SPd</i>	Display refresh rate.....	36, 39
MID.	23	Stabilization time	77, 83	
MT format	42	<i>StArt</i>	Title block	53
Numerical format	42		<i>St-b</i>	Stability band width	36, 39
Options	79	<i>St-d</i>	Time/Date output	37
<i>out</i>	Report output.....	57, 58	Tare	18, 83
<i>PS</i>	Internal mass correction	32	Target mass	83	
<i>Pnt</i>	Decimal point.....	36, 39	<i>trc</i>	Zero tracking	36, 39
<i>P-on</i>	Auto display-ON	36, 39	<i>t-UP</i>	Timeout	38
<i>Prt</i>	Data output mode	36, 40, 64	<i>tYPE</i>	Data format	37, 64
<i>PUSE</i>	Data output pause	37, 64	PCS	Unit of counting mode.....	20
<i>rEcEnd</i>	End block.....	53	Unit	12, 13, 45
Repeatability	77, 83		<i>Unit</i>	Unit.....	38
Re-zero	83	WinCT	Communication Tools	66
RsCom	66	Zero point	83
RsKey	66			



A&D Company, Limited

3-23-14 Higashi-Ikebukuro, Toshima-ku, Tokyo 170-0013, JAPAN
Telephone: [81] (3) 5391-6132 Fax: [81] (3) 5391-1566

A&D ENGINEERING, INC.

1756 Automation Parkway, San Jose, California 95131, U.S.A.
Telephone: [1] (408) 263-5333 Fax: [1] (408) 263-0119

A&D INSTRUMENTS LIMITED

Unit 24/26 Blacklands Way, Abingdon Business Park, Abingdon, Oxfordshire OX14 1DY United Kingdom
Telephone: [44] (1235) 550420 Fax: [44] (1235) 550485

A&D AUSTRALASIA PTY LTD

32 Dew Street, Thebarton, South Australia 5031, AUSTRALIA
Telephone: [61] (8) 8301-8100 Fax: [61] (8) 8352-7409

A&D KOREA Limited

한국에이.엔.디(주)
서울특별시 영등포구 국제금융로6길33 (여의도동) 맨하탄빌딩 817 우편 번호 07331
(817, Manhattan Bldg., 33. Gukjegeumyung-ro 6-gil, Yeongdeungpo-gu, Seoul, 07331 Korea)
전화: [82] (2) 780-4101 팩스: [82] (2) 782-4264

ООО A&D RUS

ООО "ЭЙ энд ДИ РУС"
121357, Российская Федерация, г.Москва, ул. Верейская, дом 17
(Business-Center "Vereyskaya Plaza-2" 121357, Russian Federation, Moscow, Vereyskaya Street 17)
тел.: [7] (495) 937-33-44 факс: [7] (495) 937-55-66

A&D INSTRUMENTS INDIA PRIVATE LIMITED

ऐ&डी इन्स्ट्रूमेन्ट्स इण्डिया प्रा० लिमिटेड
509, उद्योग विहार, फेस -5, गुडगांव - 122016, हरियाणा, भारत
(509, Udyog Vihar, Phase-V, Gurgaon - 122 016, Haryana, India)
फोन : 91-124-4715555 फैक्स : 91-124-4715599