

Optional Accessories

Part No.	Part name
< Container >	
RE-79100	15mL Beaker
RE-79101	100mL Beaker
RE-78141	Cup Adapter (with 100pcs cups) * 50pcs of paper cups and 50pcs of plastic cups are included.
RE-79102	Paper Cup (90mL, 100pcs)
RE-79103	Plastic Cup (90mL, 100pcs)
< Ultra Low Adapter (ULA)>	
RE-77120	Ultra Low Adapter (ULA) - Sample Adapter for Low Viscosity Sample <ul style="list-style-type: none"> • Sample cylinder • Hook • UL spindle • Extension (threaded tip)
	<ul style="list-style-type: none"> • Cylinder holder • Hook holder • UL stand
RE-77107	UL spindle (with hook and hook holder)
RE-77121	Sample cylinder (with cap and o-ring)
RE-77117	UL spindle 3pcs (with hook and hook holder)
< Temperature sensor >	
RE-75540	Temperature sensor

Part No.	Part name
< Spindle >	
RE-77104	A1 Spindle
RE-77105	A2 Spindle
RE-77106	A3 Spindle
RE-77114	A1 Spindle 5pcs
RE-77115	A2 Spindle 5pcs
RE-77116	A3 Spindle 5pcs
RE-77100	Set of spindles (A1,A2,A3)
< Viscosity Standard Liquid >	
RE-89030	Viscosity Standard Liquid 2 100mL
RE-89031	Viscosity Standard Liquid 5 100mL
RE-89036	Viscosity Standard Liquid 200 100mL
RE-89037	Viscosity Standard Liquid 500 100mL
RE-89038	Viscosity Standard Liquid 1000 100mL
RE-89039	Viscosity Standard Liquid 2000 100mL

* Standard liquid with JCSS calibration certificates are available (JS2.5 to JS160000).
Contact ATAGO for further details.

Specifications

Measurement range 1 to 350,000,000mPa·s, 1 to 350,000,000cP

Model	VISCO™	VISCO™-895
Cat.No.	6800	6820
Materials	Housing: SUS, Aluminum · Legs, and stand + screw: SUS	Housing, legs, and stand + screw: Aluminum
Dimensions and Weight	12x12x20cm, 1.2kg (main unit only), Stand+screw : 0.5kg Small volume beaker attachment: 0.1kg	12x12x20cm, 895g (main unit only), Stand+screw : 275g Small volume beaker attachment: 0.1kg

Common Specifications

Measurement Scales	Viscosity · Temperature · Torque%
Measurement Range	Viscosity A1 50 to 200,000mPa·s, 50 to 200,000cP A2 100 to 600,000mPa·s, 100 to 600,000cP A3 500 to 2,000,000mPa·s, 500 to 2,000,000cP (1mPa·s=1cP)
Torque	0.0 to 100.0% (recommended torque : 10.0 to 100.0%)
Temperature	0.0 to 100.0°C / 32.0 to 212.0°F
Resolution	Viscosity lower than 100mPa·s : 0.01mPa·s 100mPa·s or higher lower than 10,000mPa·s : 0.1mPa·s 10,000mPa·s or higher : 1mPa·s
Torque	Lower than 10% : 0.01% 10% or higher : 0.1%
Temperature	0.1°C / 0.1°F
Measurement Accuracy	Viscosity ±1% (Full scale) Temperature ±0.2°C / ±0.4°F
Speed	0.5 to 250 rpm, Number of speeds : 20
Sample Temperature Range	10.0 to 40.0°C / 50.0 to 104.0°F
Ambient Temperature	10 to 40°C
Computer Output	Output : USB - PC
Battery Life (Approx.)	Approx. 7 hours (continuous operation at 60rpm)
Power Supply	DC6V (AA alkaline batteries 1.5V x 4) AC adapter : AC100 to 240V, 50/60Hz

The body, legs and stage of the VISCO™-895 are made from light-weight aluminum.



Contents

· Main unit	1
· Stand:	1
· S Beaker (15mL)	1
· L Beaker (100mL)	1
· AC adapter	1
· Spindles (A1, A2 and A3)	one each
· Temperature sensor	1
· Small volume beaker attachment	1
· USB Mini-B cable (1m)	1
· 1.5V AA alkaline batteries	4
· Instruction manual	1
· Inspection certificate	1
· Spindle stand	1
· Protective cap	1
· Carrying case	1

All ATAGO products are designed and manufactured in Japan.

ATAGO CO., LTD.

https://www.atago.net/ overseas@atago.net

Headquarters: The Front Tower Shiba Koen, 23rd Floor
2-6-3 Shiba-koen, Minato-ku, Tokyo 105-0011, Japan
TEL : 81-3-3431-1943 FAX : 81-3-3431-1945



HACCP GMP GLP

ATAGO products comply with HACCP, GMP, and GLP system standards.

ATAGO U.S.A., Inc.
ATAGO INDIA Instruments Pvt. Ltd.
ATAGO THAILAND Co., Ltd.
ATAGO BRASIL Ltda.
ATAGO ITALIA s.r.l.
ATAGO CHINA Guangzhou Co., Ltd.
ATAGO RUSSIA Ltd.
ATAGO NIGERIA Scientific Co., Ltd.
ATAGO KAZAKHSTAN Ltd.

TEL : 1-425-637-2107 customerservice@atago-usa.com
TEL : 91-22-28544915 / 40713232 customerservice@atago-india.com
TEL : 66-21948727-9, 66-21171549 customerservice@atago-thailand.com
TEL : 55 16 3913-8400 customerservice@atago-brasil.com
TEL : 39 02 36557267 customerservice@atago-italia.com
TEL : 86-20-38108256 info@atago-china.com
TEL : 7-812-777-96-96 info@atago-russia.com
TEL : 234-707-558-1552 atagonigeria@atago.net
TEL : 7-727-257-08-95 info@atago-kazakhstan.com

Copyright © 2019 ATAGO CO., LTD. All rights reserved. [ENV.06] 19021000PP Printed in Japan

VISCO™



ATAGO®

ATAGO: Creating the Perfect Fusion of Innovation, Technology and Simplicity

ONE TOUCH™, ONE HAND™ and ONE BUTTON™.

Presenting the VISCO, a brand-new way of measuring viscosity with 3 simple **"ONE's."**

ONE BUTTON™

Operation requires only one dial button. All operations can be performed with the simple act of "sliding" or "pushing" the dial button. No more accidental operations due to pushing the wrong button.

Measurement

ONE TOUCH™

VISCO is very easy to set-up. The spindle can be attached with just "one touch" — simply insert the spindle in the instrument. Absolutely no complicated set-up required.

Set-up

ONE HAND™

Measurement preparation can easily be done with just one hand. Place the beaker underneath the pre-set area and place the instrument on the stand. No troublesome height adjustment necessary.

Preparation

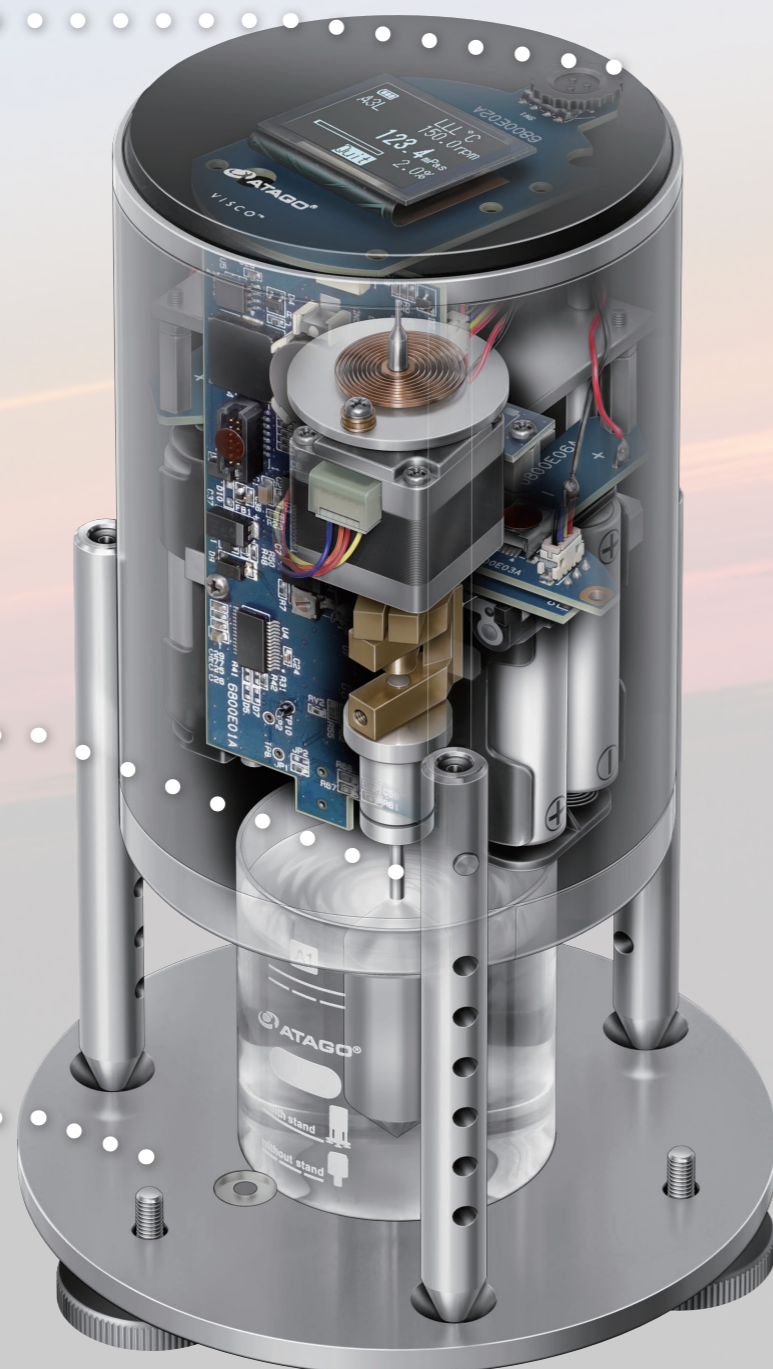

Uses Only 1/33 of the Standard Sample Amount

Standard measurement instruments for viscosity require a large amount of sample (500mL). VISCO is capable of taking measurements with just 15mL of sample. This is roughly 1/33 of the standard sample amount. Measurement can be done with only a small amount of sample, resulting in less waste of valuable sample and a significant reduction in cost.

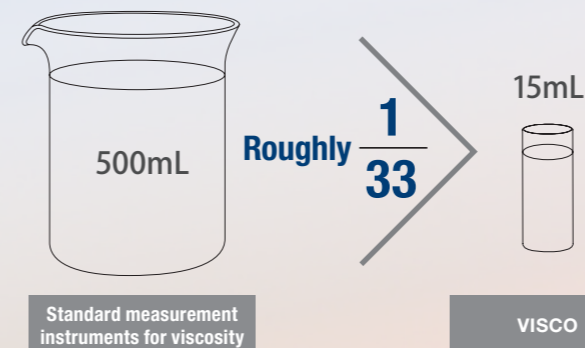

Compact and Easily Carried with One Hand

VISCO's sleek dimensions and weight (main unit: 12x12x20cm, 1.2kg) make it compact and easily carried with one hand.

The instrument's legs can be folded up, making it further compact and allowing for even greater storage capabilities.

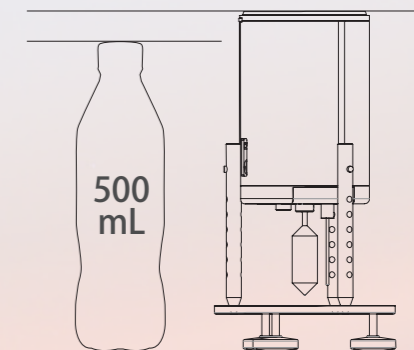

Easy to Read, Fully Digital Display

A fully digital display allows for anyone to quickly and easily read results.

The simple display is easily and readily understood.

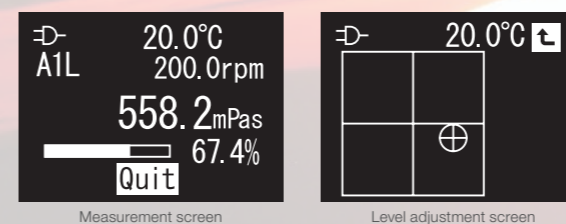

Quick Measurements Anywhere

Not only does VISCO run on AC power, but it can also operate on battery power. This allows for measurements to be taken anywhere, even in places lacking a power source. The instrument can also be placed directly on the beaker, making it possible for quick and simple measurements to be taken. No need to establish a specific location for measurement — with VISCO, you can take measurements anytime, anywhere.

Never Take Any Glassware (on site) Ever Again

Measurement can also be taken using paper cups other than those that come with the instrument. A disposable container requires no washing after each measurements. This makes it possible to safely measure even on site where no glassware is allowed.



- VISCO Package: Package A [P.4](#)
- Disposable container can be purchased independently. [P.8](#)

Using the included stand and beaker

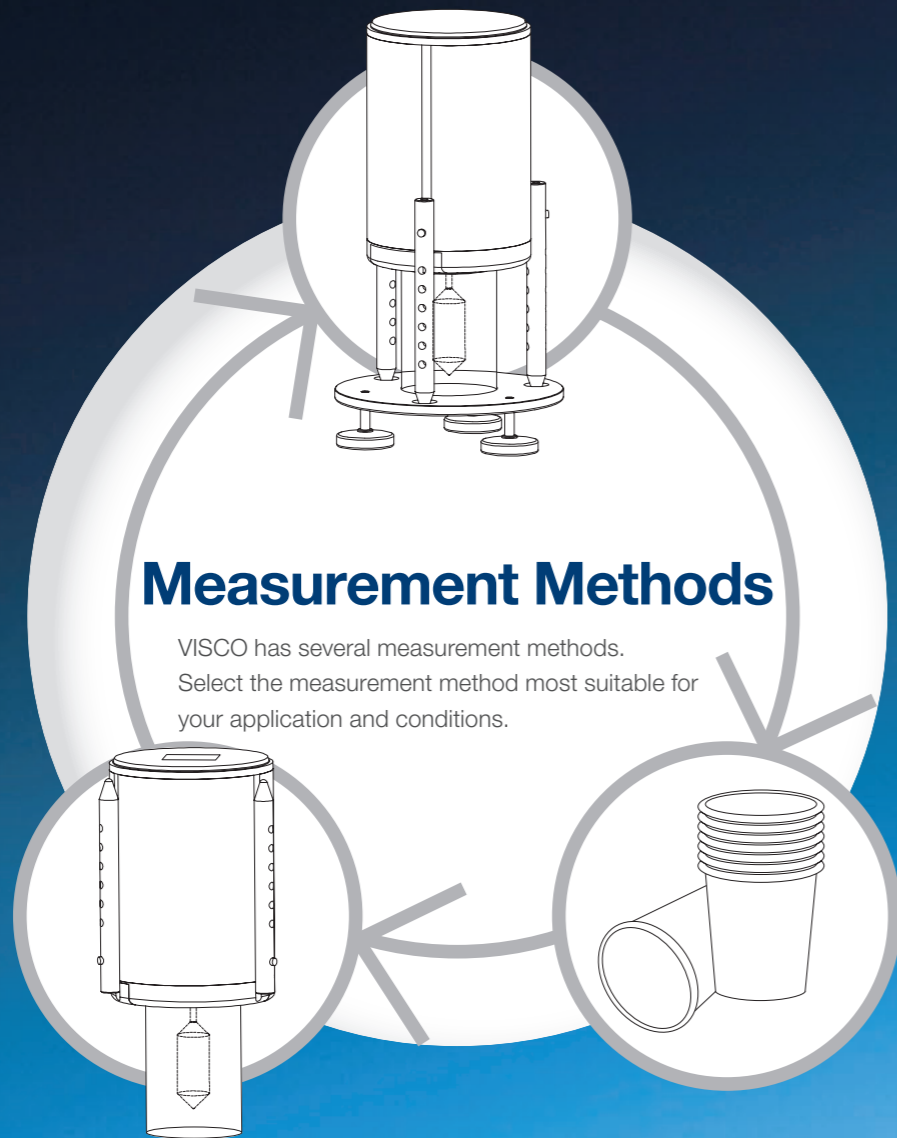

Measurement Methods

VISCO has several measurement methods. Select the measurement method most suitable for your application and conditions.

Placing the instrument directly on the included beaker

Using a disposable container

VISCO Package

Package A

Using disposable containers eliminates the hassle of cleaning after measurement. Package A, which includes a specialized adapter for use with disposable containers such as paper cups, is available at ATAGO.

- **Cat.No.6810**
 - VISCO™ (main unit)
 - Cup Adapter (with 100pcs cups*): RE-78141
- **Cat.No.6830**
 - VISCO™-895 (main unit)
 - Cup Adapter (with 100pcs cups*): RE-78141

* 50pcs of paper cups and 50pcs of plastic cups are included.

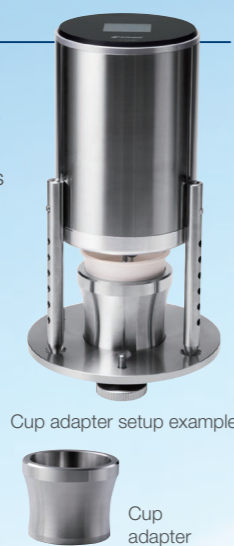

Package B

Measurement of low viscosity (1 to 2,000 mPa·s) is possible. A package that comes with Ultra Low Adapter (ULA) for measuring low viscosity sample and VISCO (main unit) is available.

- **Cat.No.6811**
 - VISCO™ (main unit)
 - Ultra Low Adapter (ULA): RE-77120
- **Cat.No.6831**
 - VISCO™-895 (main unit)
 - Ultra Low Adapter (ULA): RE-77120

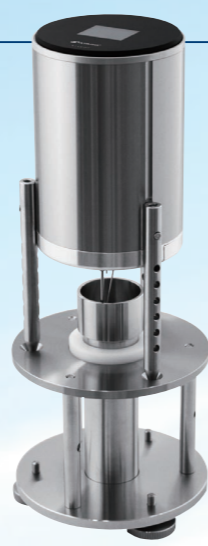

VISCO APPLICATION

Food and Beverage

Beverages (e.g. juice, etc.)



Viscosity is critical parameter in beverage manufacturing, from the production phase all the way until the product reaches consumers.

Milk



In regards to milk, aside from whole milk (3.25%), there is reduced fat milk (2%), low-fat milk (1%) and nonfat (skim) milk. In general, nonfat milk has the lowest viscosity.

Tomato Juice / Purée

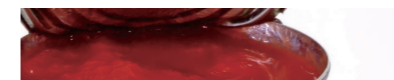

Tomato juice or purée must always flow through the production line under a constant, homogenized state. Viscosity management is indispensable to this process.

Sauce (Worcestershire sauce, thicker Worcester sauce, pork cutlet sauce, etc.)



There are many kinds of sauce. These include (in ascending order of viscosity): Worcestershire sauce, thicker Worcester sauce and pork cutlet sauce. In Japan, there are approximate levels or grades for viscosity determined by JAS.

Ketchup



Ketchup, a pseudoplastic fluid, is characterized by its propensity to remain in its bottle even when turned upside-down. Applying a bit of force (squeezing) to the bottle causes the ketchup to flow out. It is also known for reacting differently at varying temperatures.

Mayonnaise



Mayonnaise also remains in its bottle, even when turned sideways or upside-down and maintains high viscosity. The greater the force applied, the easier it will flow out and the viscosity will decrease.

Olive Oil



There are many vegetable based oils that are Newtonian fluids (a fluid that does not change viscosity even when force is applied). Olive oil is a Newtonian fluid.

Honey



Honey is a Newtonian fluid. Its viscosity is not affected by force and speed. Only temperature can cause a change in viscosity.

Jam



Imagine spreading jam on a piece of toast. The jam easily glides across the toast. Viscosity is a crucial factor in making jam spreadable. Managing the viscosity can be quite difficult, as jam contains solids.

Yogurt



Numerous factors throughout the manufacturing process, such as how much fat is left in the yogurt, pasteurization and pH management affect the final product and texture (viscosity).

Butter / Margarine



Butter is a Bingham plastic (a type of non-Newtonian fluid). It can not flow unless some degree of force is applied, but applying force past a certain degree cause it to become more malleable in proportion to the force.

Japanese Curry (curry roux)



Thickened curry (roux) is quite mainstream in Japan. Thickened curry is made by applying heat to flour, which changes it into a more paste-like consistency, resulting in an increase in viscosity. Even in the final processing stage of being sealed into a retort pouch, the curry roux must maintain the same viscosity to allow the same amount to extrude every time the same amount of force is applied.

Gelatin / Agar



Viscosity measurements can be used to check and manage the gelling process of gelatin or agar. However, if the gelatin or agar completely solidifies during viscosity measurement, a spindle-shaped gap will form, preventing measurements from being taken.

Household Essentials

Toothpaste



Toothpaste with a paste-like consistency is a Bingham plastic. It will not flow out unless the tube is squeezed. It is important for toothpaste to be at optimal viscosity. After applying the appropriate amount onto a toothbrush, toothpaste at just the right viscosity will break cleanly from the tube and retain its shape without flattening.

Shampoo and Conditioner



Conditioner must have a particularly high viscosity, as it coats every single strand of hair. The components used in shampoo and conditioner may not mix well, but adding viscosity ensures that they are evenly maintained.

Cosmetics



Viscosity measurements and research in the rheological properties of cosmetics is conducted in order to give even slightly viscous cosmetics a smooth, light, easily spreadable quality when applied.

Industrial / Chemical

Adhesives



There are many types of adhesives for different purposes and applications. For example, structural adhesives include general adhesive for temporary bonding, gap-filling adhesive and adhesive used for coating purposes. **Gap-filling adhesives:** properties, such as bond strength, leveling (smoothness) and ease/difficulty of flow are assessed through viscosity measurements.

Water glass

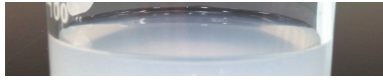

Water glass is also commonly known as, "Sodium silicate." It is often used in soaps and adhesives. It is also used in a wide variety of fields, such as engineering, paper manufacturing and pharmaceuticals. Water glass has an extraordinarily high viscosity.

Resins / Polymers



Various kinds of resins and polymers have appeared in recent years. In addition to ascertaining their properties, viscosity assessment is also an absolute must.

Photopolymers (used in 3D printing)

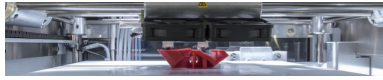

With the spread of 3D printers, photopolymers have suddenly gained traction in the global market. When photopolymers are exposed to light and heat, their viscosity increases and they harden.

Paint / Pigment / Varnish / Insulators



Paint (brush application): good brushability and drip-resistant. Tends to have a low viscosity under a high-shear rate and high structural viscous properties under a low-shear rate.
Spray painting (coating): types of spray painting include air spray painting, airless spray painting and electrostatic coating. Most air spray paints have the same structural viscous properties as paint for brush applications. Airless spray painting and electrostatic coating is utilized in applications such as the final coating in automobile painting. As such, great emphasis is placed on the appearance and finish of the paint. Compared to paint for brush applications and air spray paint, most airless spray paints have a low viscosity, with similar properties to Newtonian fluids. The leveling of the paint after it's applied affects the overall appearance of the finished products.
Electrodeposition (electrophoretic deposition): used for applying coatings to complex shapes/objects. Through electrodeposition, a film of coating is created on the surface of the target object. The object undergoes a baking or drying process, which makes the surface become smooth. This (leveling) is an extremely critical part of the process. It is necessary to use paint with viscosity sensitive to temperature.

Glycerin



Glycerin is highly viscous and it's a great moisturizer. It is often added to cosmetics to increase their moisturizing properties. It is also used in various food products as a thickening agent and as a humectant in pharmaceuticals.

Hydraulic Fluids



The viscosity of hydraulic fluid tends to decrease as the temperature rises. If the viscosity decreases too much, it may lead to deterioration in the lubricating properties of the fluid and adversely affect pump efficiency. In contrast, viscosity tends to increase as the temperature decreases. This can increase the usual amount of force needed to operate the pump, and may accelerate wear and tear. This is why you must select a hydraulic fluid with the optimal viscosity for your application.

Lubricant

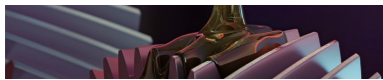

The viscosity of lubricant is a vital element, of which the life span is affected by the wear and tear of machinery. Depending on the viscosity, if too much heat is generated, the life span of a lubricant may be reduced. Not only does this increase costs, it also shortens the life span of the machinery. This is why managing the viscosity of lubricant is of the utmost importance.

Cutting Fluids



A lot of heat is generated during machining processes. Cutting fluid has a low viscosity, which makes it well-suited for effectively dissipating heat. Low viscosity is also necessary for facilitating circulation and eliminating impurities. However, to ensure precision and control when spraying or coating, the viscosity must not be too low. Managing the viscosity of cutting oil is essential.

Slurry / Ceramic Slurry (ceramic mold casting)



"Slurry" indicates a fluid which contains solid, suspended granules. Due to its properties, if it not mixed, it may precipitate. Viscosity management is critical for ensuring a smooth transition.

Thick (viscous) Food Measurement

VISCO – Thickness Meter

In recent years, Japan has faced an ever increasing, aging population. "Longevity" isn't the only point of discussion — how to extend good health throughout life expectancy and what defines QOL (Quality of Life) have also become hot topics.

Food is of course fuel for life. We essentially "eat to live," but food holds greater significance. Food can also bring us joy as a source of pleasure in our lives. Food consistency is an important component that impacts the quality of life for individuals that have difficulty in chewing and swallowing (dysphagia). VISCO can assist in managing food consistency, thereby improving the quality of life.

The Balance Between Health Care, Nutrition and Food

BAD	GOOD
Intravenous (parenteral nutrition) Medical treatment for individuals unable to obtain adequate nutrients by oral or enteral routes.	Ingestion Nutrients obtained through one's own accord (via ingestion).

As depicted above, "Ingestion," is the best way of absorbing nutrients, in regards to overall health.

The Importance of Thickening Food

A common misconception found among dysphagia diets and care facility diet plans is thickening food/drink (by grinding, pureeing, mashing, chopping, or mincing) makes it easier to swallow. In reality, thickening food reduces the flow of the substance, and on the contrary, it becomes rather difficult to swallow. If this is the case, then just why is it important to thicken food? Individuals with dysphagia (an affliction characterized by the failure in the automatic process of closing the respiratory tract to allow food to pass through the esophagus) need more time when swallowing to allow food to properly pass through the esophagus. Thickening food and beverages is effective in preventing food from accidentally passing through the respiratory tract.

Enhancing the Way Food is Experienced

In the past, dysphagia diet assessment was based solely on "hardness," but recently, it has become common to assess dysphagia diets based on 3 criteria: hardness, cohesion (ease of clump formation) and adhesion (smoothness). There was also a time when the focus was on determining the best way of intaking food to absorb the most nutrition. Nevertheless, if you don't look forward to your meals or derive any enjoyment from eating in the first place, you may gradually stop eating much of anything. Flavor isn't the only aspect to consider; food texture (mouthfeel) is also regarded with great importance. Until now, from a number of standpoints such as cost, space (installation) and operation, large sized viscosity measurement devices and expensive texture meters were utterly ill-suited for personal use and for small-scale care facilities. VISCO is compact, lightweight and portable, making it ideal for hospitals, care facilities or household use. It can quickly and easily measure and assess the textual properties (thickness) of foods for dysphagia diets and care facility diet plans. Using VISCO, anyone can look forward to savoring and enjoying safe, nutritious food.

Dysphagia Diet Pyramid

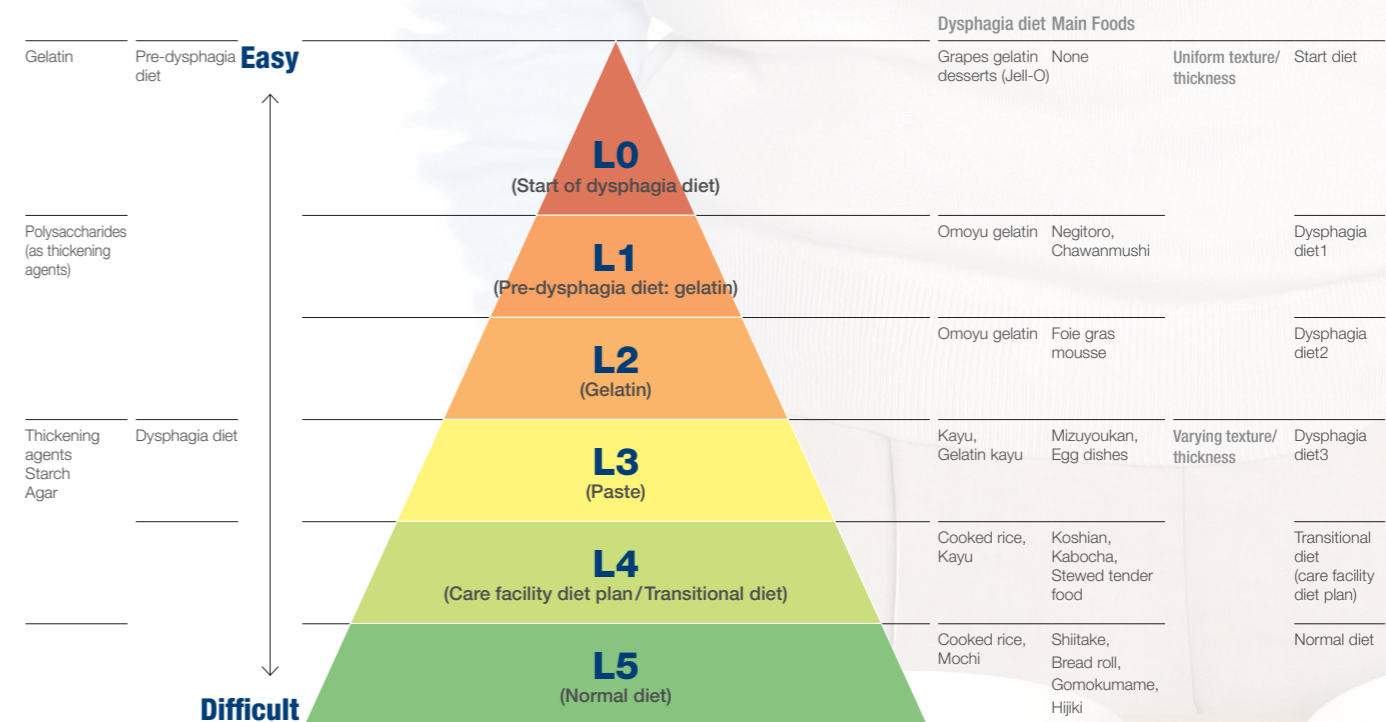

Omoyu gelatin (rice broth based gelatin), **Kayu** (rice gruel), **Gelatin kayu** (gelatin based rice gruel), **Mochi** (Japanese rice cake made of mochigome, a short-grain japonica glutinous rice), **Negitoro** (the fatty flesh of tuna minced to a paste and mixed with chopped green leaves of Welsh onions), **Chawanmushi** (a cup-steamed egg custard hotchpotch), **Foie gras** (a food product made of the liver of a duck or goose that has been specially fattened), **Mizuyoukan** (a thick, soft jellied dessert made of red bean paste, agar and sugar), **Koshian** (boiled, mashed sweet red bean paste), **Kabocha** (Japanese pumpkin; a variety of winter squash of the species Cucurbita maxima), **Shiitake** (a variety of edible Japanese mushroom), **Gomokumame** (a Japanese dish consisting of cooked soybeans with various vegetables), **Hijiki** (a type of edible seaweed; Hizikia fusiforme)